



OWNER'S
MANUAL



2000 MODELS

All information and specifications included in this manual were in effect at the time of approval for printing. Malibu Boats West, Inc. reserves the right, however, to discontinue or change specifications or design at any time without notice and without incurring any obligation.

Trademarks

Malibu, the Malibu Logo, Flightcraft, and Computron ATD are registered trademarks of Malibu Boats West, Inc.

Mercury, Mercury Marine, Merc, and Mercruiser are registered trademarks of Brunswick Corporation.

All other product names are copyright and registered trademarks/trade names of their respective owners.

© 1993, 1994, 1995, 1996, 1997, 1998, 1999, 2000 Malibu Boats West, Inc.
All rights reserved.
Printed in the USA

CONTENTS

CONTENTS	iii	Navigation Lights	2-9
TABLE OF FIGURES	iv	Storage Areas	2-10
INTRODUCTION	v	Drain Plugs.....	2-10
BOATING SAFETY	1-1	Speedometer Pickups	2-11
General Precautions	1-1	Tilt Steering Wheel.....	2-11
Safety Statements.....	1-1	Optional Equipment	2-12
Regulations.....	1-2	Wedge.....	2-14
Responsibilities	1-2	Warning Labels	2-15
Emergencies	1-4	OPERATION	3-1
Hazardous Conditions	1-5	Trailering	3-1
Carbon Monoxide.....	1-6	Fueling	3-4
Operation By Minors	1-7	Starting	3-4
Passenger Safety.....	1-7	Shifting/Running	3-5
Basic Rules of the Road.....	1-7	Steering	3-5
FEATURES & CONTROLS	2-1	Stopping	3-7
Standard Gauges.....	2-1	Docking	3-8
Optional Gauges.....	2-3	High Speed Operation	3-9
Circuit Breakers	2-4	Trimming	3-9
Accessory Switch Panels	2-4	Towing a Skier	3-10
Throttle Control	2-5	Towing Another Boat.....	3-12
Steering System	2-6	Anchoring.....	3-12
Power Trim.....	2-6	Propellers	3-13
Emergency Engine Stop Switch... 2-6		Corrosion Protection	3-14
Bow Tonneau Cover.....	2-6	CARE AND MAINTENANCE	4-1
Motorbox Cover.....	2-7	Interior	4-1
Driver's Seat.....	2-7	Exterior.....	4-1
Integral Self Draining		Engine/Drive Train.....	4-3
Ice Chest	2-7	Fuel Shutoff Valve	4-3
Sundeck	2-8	Electrical	4-4
V-Drive Engine Access		Miscellaneous.....	4-5
Hatch	2-8	Troubleshooting	4-6
Ski Pylon.....	2-9	Warranty Information.....	4-9
Swim Platform	2-9	Other Manufacturer Warranties .. 4-10	
		Owner Service Assistance	4-10
		Glossary	4-12
		Index.....	4-13

TABLE OF FIGURES

Figure 1-1 Personal Flotation Devices	1-3	Figure 2-18 Lockable Transom Storage	2-10
Figure 1-2 Fire Extinguisher	1-3	Figure 2-19 Transom Drain Plug	2-10
Figure 1-3 Weather Hazards	1-5	Figure 2-20 Bilge Drain Plug	2-11
Figure 1-4 Diver Down Flag	1-5	Figure 2-21 Speedometer Pickups	2-11
Figure 1-5 Carbon Monoxide Hazards	1-6	Figure 2-22 Tilt Steering	2-11
Figure 1-6 Regulatory Markers	1-8	Figure 2-23 Heater	2-12
Figure 1-7 Buoy Shapes	1-9	Figure 2-24 Bimini Top Screw	2-12
Figure 1-8 Spherical Marker	1-9	Figure 2-25 Strap Eyelet	2-12
Figure 1-9 Day Markers	1-9	Figure 2-26 Stereo	2-12
Figure 1-10 Crossing Situation	1-10	Figure 2-27 Shower Head	2-13
Figure 1-11 Overtaking Another Craft	1-11	Figure 2-28 Shower Valve	2-13
Figure 2-1 Tachometer/Hourmeter	2-1	Figure 2-29 Pop-Up Cleat	2-13
Figure 2-2 Speedometer	2-2	Figure 2-30 Accu-Ski	2-13
Figure 2-3 Multi Gauge	2-2	Figure 2-31 Wedge Down	2-14
Figure 2-4 Digital Clock	2-3	Figure 2-32 Wedge Up	2-14
Figure 2-5 Depth Finder	2-3	Figure 3-1 Trailer Hitch	3-1
Figure 2-6 Circuit Breaker Panel	2-4	Figure 3-2 Safety Chains	3-2
Figure 2-7 Accessory Switch Panel	2-4	Figure 3-3 Bow Tie-Down	3-2
Figure 2-8 Throttle	2-5	Figure 3-4 Transom Tie-Down	3-2
Figure 2-9 Stop Switch Lanyard	2-6	Figure 3-5 Fueling	3-4
Figure 2-10 Motorbox	2-7	Figure 3-6 Throttle Positions	3-5
Figure 2-11 Driver's Seat	2-7	Figure 3-7 Turning With A Rudder	3-6
Figure 2-12 Sundeck	2-8	Figure 3-8 Stern Push	3-7
Figure 2-13 Engine Access Hatch	2-8	Figure 3-9 Docking With Wind/Current	3-8
Figure 2-14 Pivoting-Head Ski Pylon	2-9	Figure 3-10 Boat Trim	3-10
Figure 2-15 Swim Platform	2-9	Figure 3-11 Hand Signals	3-11
Figure 2-16 Swim Step Pins	2-9	Figure 3-12 Towing	3-12
Figure 2-17 Bow Light	2-9	Figure 3-13 Propeller	3-13
		Figure 4-1 Battery Level	4-4

INTRODUCTION

Over the years, you have watched us grow into one of the most respected boat builders in the world. And undoubtedly, somewhere you have run into at least one Malibu owner who proudly speaks of the “Malibu Difference.” That difference they so proudly speak of could be the special way we have serviced them over the years. We call it “going the distance.” Or maybe they are referring to the way their Malibu consistently outperforms other ski boats that they have driven. We can’t deny that we are different. Our passion for building the perfect ski boat is only surpassed by our commitment to total customer satisfaction.

This manual has been assembled to help you operate your new Malibu with safety and pleasure. Details of typical equipment as well as recommended safety and maintenance procedures about your boat are supplied. Please read carefully and familiarize yourself with the craft before using it.

We, at Malibu Boats, thank you for choosing us as your boat manufacturer and assure you that your satisfaction and boating enjoyment will continue to be our #1 priority.

Chapter 1

BOATING SAFETY



At Malibu, safety is not an option!

General Precautions

Your Malibu boat has been constructed to meet all U.S. Coast Guard and National Marine Manufacturers Association (N.M.M.A.) requirements. However, it is still your responsibility as the boat owner, to ensure the boat is always operated in a safe fashion.

U.S. Coast Guard regulations require certain safety equipment be present on your boat during operation. Besides the U.S. Coast Guard regulations, other local and/or international law enforcement agencies may have similar requirements. You should check with your local marine enforcement agency regarding any such requirements before using the waterways.

It is not intended for this manual to be a replacement for a course on boating safety. It is highly recommended that if you are unfamiliar with the use and operation of a boat, you seek advice and training from a qualified individual or organization. Check with your local boating agency or Malibu dealer for more information about boating safety classes in your area.

Safety Statements

Throughout this manual, specific precautions and symbols identify safety related information. Follow these precautions as indicated.



The Safety Alert symbol means Attention! Become Alert! Your Safety Is Involved!

DANGER



*Indicates the presence of a hazard which **WILL** cause **SEVERE** injury, death or substantial property damage.*

Warning



*Indicates the presence of a hazard which **CAN** cause **SEVERE** injury, death or substantial property damage.*

Caution

*Indicates the presence of a hazard which **WILL** or **CAN** cause **MINOR** or **MODERATE** personal injury or property damage.*

Notice: Indicates installation, operation or maintenance information which is important but not hazard related.

The precautions listed in this manual and on the boat are not all-inclusive. If a procedure or method is not specifically recommended, you must satisfy yourself that it is safe for you and your passengers, and that the boat will not be damaged or made unsafe as a result of your decision. Remember — always use common sense when operating your boat!

Regulations

The U.S. Coast Guard is the governing authority of the waterways and is there to help the boating public. State boating regulations are enforced by local authorities. You are subject to marine traffic laws and “Rules of the Road” for both federal and state waterways; you must stop if signaled to do so by enforcement officers and permit to be boarded, if asked.

Responsibilities

Registration

Federal Law requires that all motorboats be registered and that all motorcraft not documented by the U.S. Coast Guard display registration numbers. In nearly all states, this means registration with the designated state agency. In a few jurisdictions, the Coast Guard retains registration authority. Your Malibu dealer will either supply registration forms or tell you where they may be obtained. The agency will supply you with a certificate which must be carried with you when the boat is in operation.

Education

If you have never owned a boat before you can get an excellent introduction to boat handling from organizations such as the U.S. Coast Guard and American Red Cross. Even if you are a veteran boater, these courses will help sharpen your boating skills as well as bring you up to date on current rules and regulations. See your local boating agency or Malibu dealer for information on classes in your area.

Insurance

The boat owner is legally responsible for damages or injuries he or she causes. Common sense dictates that you carry adequate personal liability and property damage insurance on your boat, just as you would on your automobile. You should also protect your investment from physical damage or theft.

Safety Equipment

U.S. Coast Guard regulations require certain accessory equipment on each boat. For a detailed description, obtain “Federal Requirements for Recreational Boats” published by the Coast Guard.

- 1) Personal Flotation Devices (PFDs): PFDs must be Coast Guard approved, in good and serviceable condition and the appropriate size for the user. It is recommended that you wear PFDs while your boat is underway.

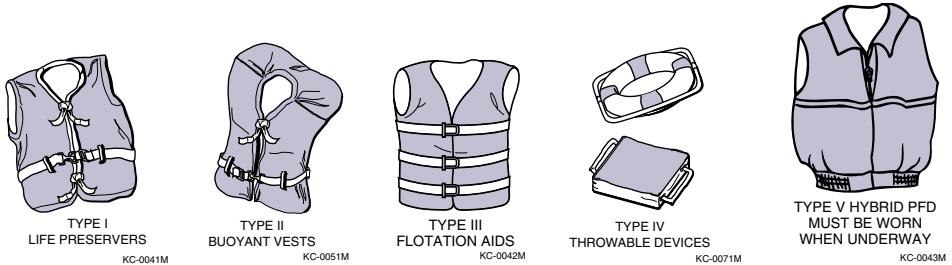

Figure 1-1. Personal Flotation Devices

Boats more than 16 feet in length must be equipped with one type I, II, III or V and one type IV. PFDs are intended to save lives, you and your passengers should wear while in the boat. Learn how to use them and adjust as necessary to make comfortable to wear. The type II PFD is recommended for near shore or inland water use. Some PFDs are specially made for use while waterskiing and can handle impacts if a skier has fallen.

Notice: If a type V PDF is to be counted toward the minimum carriage requirements, it must be worn.

- 2) Emergency Stop Switch: Factory installed lanyard emergency stop switch. It is highly recommended that you use this switch since it can prevent your boat from becoming a runaway. (See page 2-11 for specific use.)
- 3) Fire Extinguishers: A fire extinguisher is required if your boat has an inboard engine, or when fuel is stored in closed stowage compartments.

Approved fire extinguishers are classified by a letter symbol, either B-I or B-II with the B designating that the material will extinguish flammable liquids such as gasoline, oil, etc. B-I extinguishers are required for boats less than 26 feet in length. Check periodically to insure that the extinguisher is in working condition and fully charged.

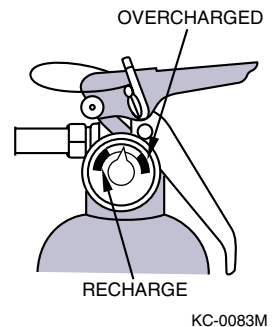

KC-0083M

Figure 1-2. Fire Extinguisher

- 4) **Navigation Lights:** Recreational boats are required to display navigational lights between sunset and sunrise and other periods of reduced visibility (fog, rain, haze, etc.). Your navigation lights are provided to keep other boats informed of your presence and course. It is up to you to make sure they are operational and turned on when required.

Emergencies

Giving Assistance

Many of the distress calls are not true emergencies. In most cases the boat is disabled for one reason or another, but there is no immediate danger of death or serious injury. However, emergencies can occur and you should know how to cope with them. If you observe a boat in distress, assume it is a true emergency. Proceed to the scene and render assistance. Federal law requires boat operators to offer assistance and aid to others. The Law's "Good Samaritan" clause absolves you from any civil liability in the event that your assistance causes injury or property damage.

There is a way to handle nearly every emergency if you don't panic. Learn your boating lessons and safety procedures well, and you will have the confidence and ability to handle an emergency should one arise.

Fires

Many boat fires involve flammable liquids such as gas or oil. Many inboard fires start in the bilge area which at times can be filled with gas vapors. Since gas vapors cannot be seen, boat fires tend to travel very fast. If you encounter a fire onboard, turn off the engine immediately. If you have a fire extinguisher onboard and access to the fire, it may be controllable. Direct the contents of the extinguisher at the base of the flames. Throw burning materials overboard if possible. Put on PFDs if not already on, signal for help and prepare to abandon the boat if necessary.

Reporting

Boat operators are required by law to file a Boating Accident report with their state boating law enforcement agency when their boat is involved in certain boating accidents. A boating accident must be reported if there is a loss or probable loss of life, personal injury requiring medical attention, damage exceeding \$500, or there is a complete loss of the boat. If any of these conditions arise seek further assistance from local law enforcement personnel.

Hazardous Conditions

Every waterway poses hazards that should be avoided. The following information outlines some of the hazards which may be encountered.

Weather

Learn and understand weather patterns and signs of change. Bad weather can cause an uncomfortable and unsafe situation. If a storm approaches seek a safe harbor.

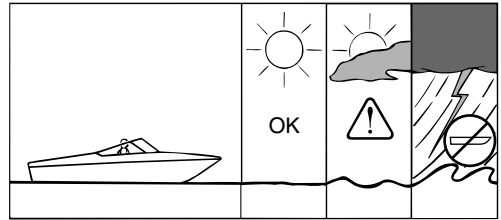

KC-0210M

Figure 1-3. Weather Hazards

Dam Spillways

The area around dam spillways is very hazardous and conditions can change rapidly. Stay clear of the spill ways and areas below dams.

Weeds

Weeds can generally be a threat to a boat's engine and other components on the boat. If weeds wrap around the propeller they can create vibration in the engine. They also restrict water intake, causing the engine to overheat, and can clog speedometer pickup tubes, affecting correct speedometer readings.

Shallow Water Operation

Shallow water brings on obvious hazards such as sand bars, stumps, rocks, etc. Know the area you will be operating the boat in. Hitting objects at high speeds can cause severe damage to people and the boat. If you know you will be navigating the boat in shallow water, post a lookout and proceed slowly.

Know the minimal depth your boat can safely travel.

Caution | *Damage to underwater gear caused by shallow water maneuvering is not covered by your warranty.*

Warning Markers

Learn to recognize the different buoys and day markers; they are used as the signposts of the waterways identifying navigable routes and water hazards. It is a good idea to ask local authorities about hazard areas and if they are marked. Stay within boundaries and clear of hazards.

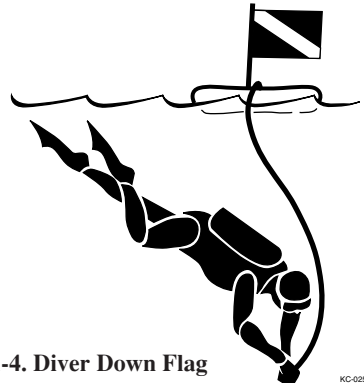

Figure 1-4. Diver Down Flag

KC-0250M

Carbon Monoxide

Carbon Monoxide (CO) is a colorless and odorless gas produced by all engines and fuel burning appliances. Even with the best boat design and construction, plus the utmost care in inspection, operation, and maintenance, hazardous levels of CO may still be present in accommodation spaces under certain conditions. To reduce CO accumulation, always ventilate the boat interior and avoid boating situations which cause increased exposure.

DANGER



EXTREME HAZARD – Carbon monoxide gas (CO) is colorless, odorless and extremely dangerous. All engines and fuel burning appliances produce CO as exhaust. Direct and prolonged exposure to CO will cause BRAIN DAMAGE or DEATH. Signs of exposure to CO include nausea, dizziness and drowsiness. Sources of CO include:

- 1** Blockage of boat exhausts by obstruction.

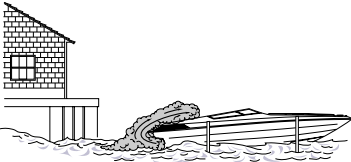

- 2** Exhausts traveling along obstruction.

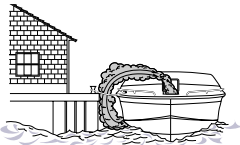

- 3** Operating at slow speed or while dead in the water.



- 4** Operating with high bow angle.



- 5** Exhausts from other vessels in confined areas.



- 6** Operating with canvas tops and side curtains in place without ventilation.



ENSURE ADEQUATE VENTILATION FOR CORRECT AIR MOVEMENT THROUGH BOAT!

KC-0461M

Figure 1-5. Carbon Monoxide Hazards

Operation By Minors

If your boat will be operated by a minor, remember to have an adult present at all times. Many states have laws regarding minimum age and licensing requirements for minors. Contact state and local authorities for special requirements that may apply in your area.

Passenger Safety

Any time you take your boat out, make sure that there is at least one other passenger aboard who is familiar with the operation of your boat. Passengers should be well aware of emergency equipment and shown how to use it. Passengers should also keep hands and feet in the boat and be safely seated while the boat is in motion.

Your boat should never be operated while you are under the influence of alcohol or drugs. Reaction times can be reduced and judgment affected creating situations that can be very dangerous.

Warning



Federal and state laws prohibit operating a boat under the influence of alcohol and other drugs. These regulations are actively enforced. Impaired operation may result in severe personal injury or death.

Basic Rules Of The Road

Warning



The nautical rules of the road must be followed to prevent collisions between vessels. Like traffic laws for automobiles, the operator is legally required to follow the rules.

The following information outlines only the most basic of the nautical rules of the road. For more information, contact your local U.S. Coast Guard Auxiliary.

Aids to Navigation

Learn to recognize the different buoys and day markers; they are the signposts of the waterway. There are 2 primary marking systems in use in the U.S.; the Uniform State Waterway Marking System (USWMS) used on inland waters and maintained by each state, and the Federal Waterway Marking System (FWMS) used on coastal waters and rivers and maintained by the U.S. Coast Guard (USCG). In addition, the FWMS has two modified systems; Western River Buoyage, and Intracoastal Waterway Buoyage. Be sure to check with local authorities on the buoyage system in use.

The type of hazard/warning buoys and markers depends on the area of jurisdiction. Check with local boating authorities.

USWMS System

In the USWMS Lateral System, well defined channels are marked with red and black buoys. Lateral means the sides of the channel are marked and the boat should pass between them.

The USWMS Cardinal System is used when there is no well defined channel or where an obstruction may be approached from more than one direction. With the cardinal system:

- Pass north or east of BLACK-TOPPED WHITE buoy.
- Pass south or west of RED-TOPPED WHITE buoy.
- RED and WHITE VERTICALLY STRIPED buoy indicates boat should pass outside of the buoy (away from shore).

Uniform State Regulatory Markers

USWMS regulatory markers are white with international orange geometric shapes; you must obey regulatory markers.

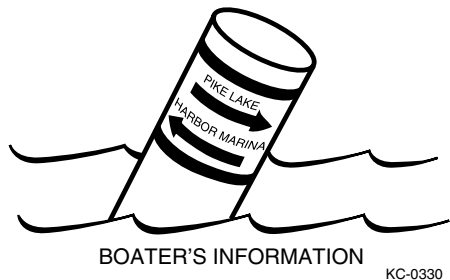
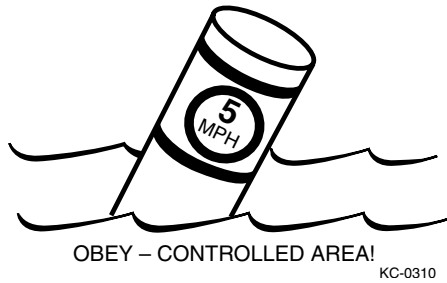
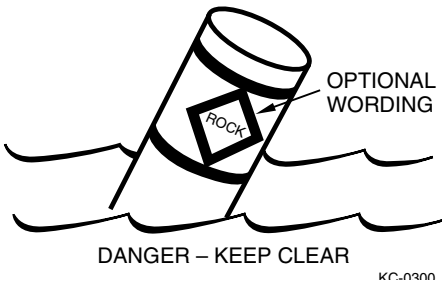

Figure 1-6. Regulatory Markers

FWMS System

The FWMS Lateral System is for use on navigable waters except Western Rivers and Intracoastal Waterways.

The markings on these buoys are oriented from the perspective of being entered from seaward (the boater is going towards the port). This means that red buoys are passed on the starboard (right) side of the vessel when proceeding from open water into port, and green buoys to the port (left) side.

The right side (starboard) of the channel is marked with RED, even numbered buoys. The left (port) side of the channel is marked with GREEN, odd numbered buoys.

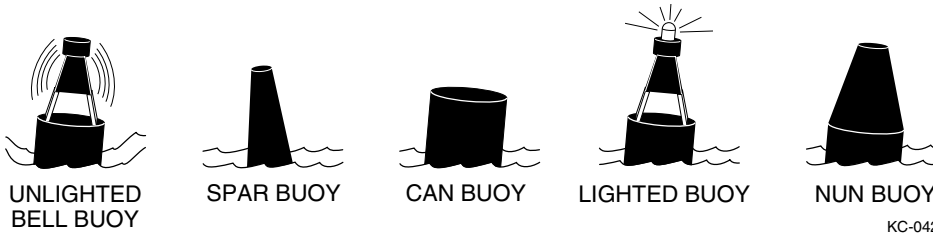

Figure 1-7. Buoy Shapes

The middle of the channel is marked with RED and WHITE vertically striped buoys; pass close to these buoys.

Obstructions, channel junctions, etc. are marked with RED and GREEN horizontally striped buoys.

A RED band at the top means the preferred channel is to the left of the buoy; a GREEN top band means the preferred channel is to the right of the buoy.



Day markers are colored and numbered the same as buoys. RED, triangular day markers with even numbers mark the starboard side of the channel. GREEN, square day markers with odd numbers mark the port side of the channel.

Lights, bells and horns are used on buoys for night or poor visibility conditions.

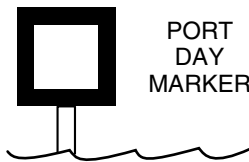

KC-0440

Figure 1-9. Day Markers

Right-Of-Way

Notice: In general, boats with less maneuverability have right-of-way over more agile craft. You must stay clear of the vessel with right-of-way and pass to his stern.

Privileged Boats

Privileged boats have right-of-way and can hold course and speed. Sailboats and boats paddled or rowed have the right-of-way over motor boats. Sailboats under power are considered motorboats. Small pleasure craft must yield to large commercial boats in narrow channels.

Burdened Boats

The burdened boat is the boat that must make whatever adjustments to course and speed necessary to keep out of the way of the privileged boat.

Crossing Situation

In crossing situations, the boat to the right from the 12 o'clock to the 4 o'clock position has the right-of-way. It must hold course and speed. The burdened boat keeps clear and passes behind the privileged boat. Boats going up and down a river have the privilege over boats crossing the river.

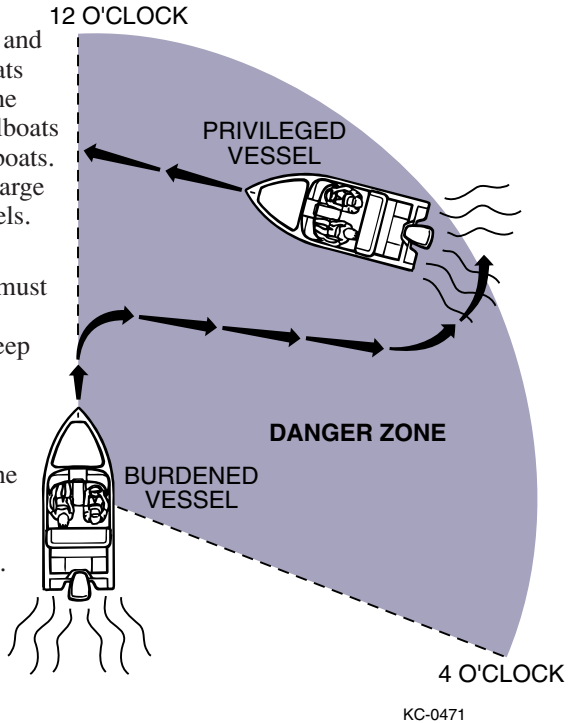

KC-0471

Figure 1-10. Crossing Situation

Meeting Head-On

Neither boat has the right-of-way in this situation. Both boats should decrease speed, should turn to the right, and pass port-to-port. However, if both boats are on the left side of a channel, each vessel should sound two short horn blasts and pass starboard to starboard.

Overtaking

The boat that is overtaking one ahead of it is the burdened boat and must make any adjustments necessary to keep out of the way of the privileged boat.

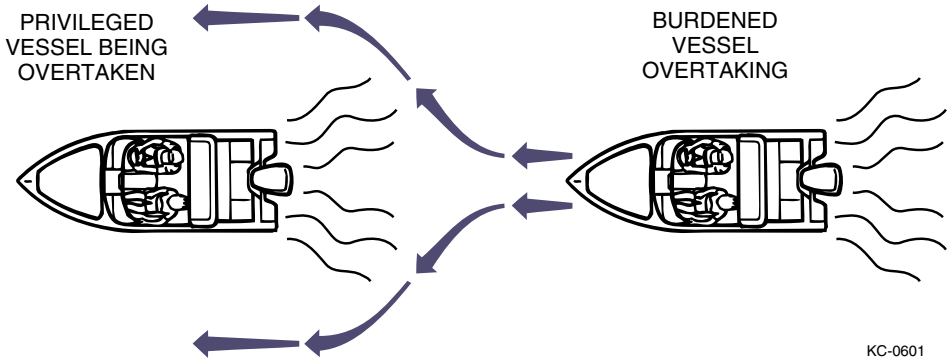

Figure 1-11. Overtaking Another Craft

The General Prudential Rule

The general prudential rule regarding right-of-way is that if a collision appears unavoidable, neither boat has right-of-way. As prescribed in the Rules of the Road, both boats must act to avoid collision.

Night Running

Boats operating between sunset and sunrise (hours vary by state) must use navigational lights. Nighttime operation, especially during bad weather or fog can be dangerous. All Rules of Road apply at night, but it is best to slow down and stay clear of all boats, regardless of who has right-of-way. Protect your night vision by avoiding bright lights and have a passenger, if possible, help keep watch for other boats, water hazards, and aids to navigation.

Chapter 2

FEATURES & CONTROLS



No other ski boat manufacturer incorporates in their product, as many innovative and technically advanced features, as Malibu.

Standard Gauges

The following standard gauges are included on all models except where noted. It is important for the safe and proper operation of your boat to fully understand these gauges.

Tachometer

Located top right of the dash panel the tachometer registers the operating speed of your engine in revolutions per minute (RPM). This gauge is used to provide you with information needed to ensure the operation of the engine is kept within engine manufacturer's proper range of operation. Be sure to consult your engine manual for the correct range of operation for your particular model.



Figure 2-1. Tachometer/Hourmeter

Caution

Do not operate the engine with the tachometer in the red area. Your engine or other parts could be damaged. Damage caused to your engine or boat due to operation of the engine in the red area may not be covered by your engine warranty.

Engine Hourmeter

Located on the bottom center of the tachometer gauge is the engine hourmeter. This meter will help identify how much your boat is being used and at what time the engine will require servicing. The hourmeter will run whenever the ignition is on.

The engine hour gauge acts as an odometer for the engine. Engine hours should always be noted so maintenance and lubricant changes may be performed at proper intervals. Please refer to your engine manual to determine maintenance schedules.

Speedometer

This gauge registers the speed of the boat in miles per hour (MPH). To adjust the speedometer gauges, locate the speedometer adjustment switch located on the center bottom panel of the of the dash. The speedometer adjustment is the left-hand button. The right-hand button is the speedometer pick-up selection and will regulate which speedometer is being used should one of your speedometer pickup tubes become clogged with debris.



Figure 2-2. Speedometer

Multi Gauge

This single gauge combines the functions of four individual gauges for quick monitoring at-a-glance.

- **Temperature Gauge**

The Temperature Gauge indicates the temperature of the water/coolant inside the engine. The proper operating range for your engine is between 140-160 degrees Fahrenheit. Engines equipped with the optional Monsoon engine have a control in the engine control module that will cause the engine to run at reduced speeds if the module senses that the engine is running to hot. If you notice that your speed has reduced during normal operation without reducing the throttle, monitor your temperature gauge. If your gauges indicate excessive temperatures during operation, slow down immediately and turn off engine.

Continuing to operate the boat while the temperature is above normal operating parameters may cause serious damage to your engine. **Ref. Kysor Medallion Gauge.**



Figure 2-3. Multi Gauge

- **Voltmeter Gauge**

The voltmeter indicates whether the battery is charging or discharging. The needle should be in the normal range (approximately 14 volts) while the engine is running. Readings in either warning zone indicate a possible problem in the electrical system.

- **Fuel Gauge**

The fuel gauge indicates the quantity of fuel remaining in the tank when the ignition is in the “ON” position. Although your fuel tank will still have some fuel remaining even though the gauge reads empty, it is recommended that the tank be filled when the gauge indicates 1/4 full.

Notice: It is not uncommon during the operation of your boat for the fuel gauge to register slightly different amounts than what is actually in the tank. This is normal operation and does not indicate a problem.

For more information on fueling your boat, see “Fueling” under the “Operation” section of this manual.

● **Oil Pressure Gauge**

The oil pressure gauge indicates the oil pressure in the engine while the engine is running and is measured in pounds per square inch (psi). Oil pressure may vary with engine speed, outside temperatures, oil viscosity, and other environmental factors but readings above the low pressure zone indicate the normal operating range. If the oil pressure reading is below the normal range, you should stop the engine immediately and check your oil as soon as possible.

Caution | *Damage to your engine due to neglected oil problems can be costly and may not be covered under your engine warranty.*

Optional Gauges

Digital Clock

Located on the lower right side of your dash is the optional digital clock mount. This feature gives you readings to a 10th of a second. For additional operating information on this option, please refer to the owners manual provided in your boat packet.



Figure 2-4. Digital Clock

Depth Finder

Located on the left side of the dash, the depth finder transmits and receives ultrasonic sound waves determining distance by measuring the time it takes off the bottom or other items under the water. The information is displayed by digital readout to give depth reading.

If your boat is equipped with this option, you should find information on its use in your owner’s information packet.



Figure 2-5. Depth Finder

Circuit Breakers

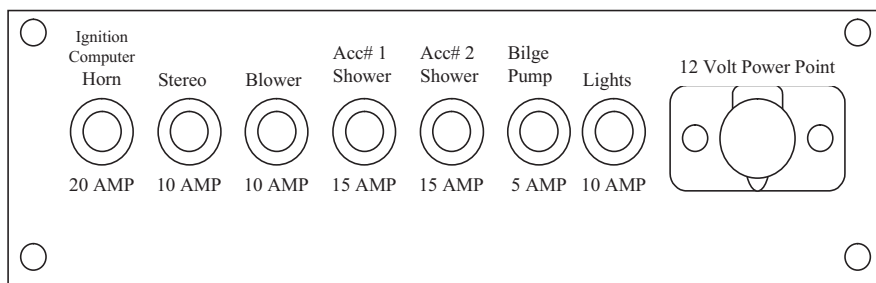
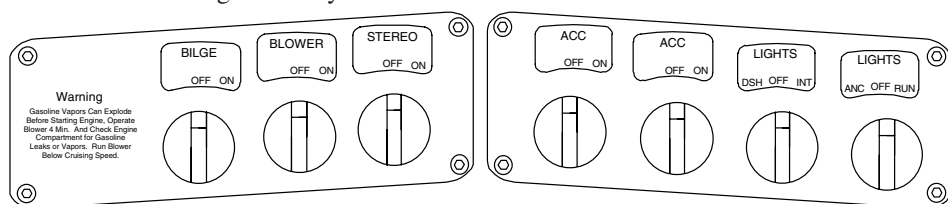

Figure 2-6. Circuit Breaker Panel

All major boat circuits are protected from shorting and overload by resettable circuit breakers. If a problem develops with one of the following circuits, switch off the circuit and wait about one minute. Then push the appropriate breaker button fully and switch on the circuit. If the circuit continues to trip, there is a problem somewhere in the system. See your dealership immediately to locate the problem.

Accessory Switch Panels

These panels are located on the dash directly below the standard gauges and are used to activate the following accessory features.



MAL-1

Figure 2-7. Accessory Switch Panel

Bilge Pump

The bilge pump switch is used to activate the bilge pump so that any excess water in the bilge area may be drained out. You should know that the bilge pump has a sensor in the bilge area and will turn on automatically whenever two inches or more of water is detected.

Blower

This switch activates the blower for the engine compartment. The primary function of the blower is to eliminate any fumes in the motor compartment when starting the engine or during idling.

Warning

Gasoline Vapors Can Explode. Before starting engine, operate blower for 4 minutes and check engine compartment for gasoline leaks or vapors. Run Blower below cruising speed.

Stereo

This switch must be on for your stereo to have power. Please see the stereos owner's manual for operating instructions.

Accessory #1

This switch is used to supply power to the optional heater unit. (For information on the heater use, please see heater operation in the options' section of this manual.)

Accessory #2

This switch is used to supply power to the optional hot water shower. (For information on the use of the hot water shower, please see hot water shower usage in the options' section of this manual.)

Interior Lights

This switch is used to activate the interior lights. The interior lights include lights in the gunnels, storage compartments, and dashboard.

Navigational Lights

In the ANC (anchor) position, this switch is used to activate the stern light. Keep the stern light on after dusk whenever your boat is at rest in the open waterway. While underway, place the switch in the RUN position to also activate the red and green navigation bow lights.

Throttle Control

The throttle lever is located to the right of the driver. When the throttle is vertical, it is in the "NEUTRAL" position. At the base of the throttle you will find the shift lock. Pulling outward on this button disengages the transmission, thereby allowing use of the throttle without engaging the transmission. This is needed for starting or warm-up of the engine. Be sure to position the throttle vertically (in "NEUTRAL") before re-engaging the transmission, by depressing the button.



Figure 2-8. Throttle

When engaging the transmission from "NEUTRAL" to either forward or reverse, you must pull up on the safety collar located directly below the throttle lever knob.

Warning

Before starting engine or engaging transmission, ensure all swimmers are out of the water.

For more information regarding the safe operation and maintenance of the throttle control, refer to the separate instructions located in the information packet shipped with your boat.

Steering System

It is important that you get the “feel” of your Malibu boat’s steering system. Turn the wheel from full left to full right, and make sure the rudder is turning accordingly. The system should operate freely and smoothly.

Notice: It is normal for your Malibu steering to pull slightly to the right under normal driving conditions. The boat will pull straight while skier is under tow.

Power Trim

This switch is located forward of the throttle. It is used to activate the trim/tilt function on the Flightcraft Outboard boats. Push and hold the switch until the engine is at the desired angle. Use this switch to maximize boat performance in the water. The tilt raises the drive for trailering.

Emergency Engine Stop Switch

The emergency engine stop switch attaches to the driver of the boat and shuts down the engine if the driver of the boat is accidentally forced away from the helm.

The switch consists of a helm-mounted switch plunger and a switch clip/lanyard clip, which is connected between the stop clip and the operator. Should the operator move away from the controls, the clip pulls free, releasing the plunger and stopping the engine. If the engine must be shut down quickly, a pull on the cord to release the clip from the switch will stop the engine.



Figure 2-9. Stop Switch Lanyard

To reset the switch after activation, reinstall the switch clip.

Notice: If lanyard switch is damaged or lost you can purchase a new switch through your local marina or Malibu dealer.

Bow Tonneau Cover

The tonneau cover is available on all walk-through open bow boats and is available as an option on all other open bows. To install, begin at the bow of the boat attach snaps by snapping cover to the deck of the boat. Work towards the windshield and walk-through. Close the door on the windshield and attach snaps to the door, to remove simply reverse procedure.

Notice: The tonneau cover is not attached at the manufacturing facility unless specified during boat order. If you would like tonneau attached, please see your Malibu dealer.

Motorbox Cover



The upholstered motorbox reduces engine noise and provides protection for the passengers on board. To open, stand on the port side of the box near the observer seat, grasp the handle near the floor and pull open. The motor box is equipped with either one or

two gas-filled shock absorbers (depending on model) to provide support for the compartment when opened.

Figure 2-10. Motorbox

Warning



Running the engine with the motor box open exposes rotating machinery which can cause injury to occupants of the boat.

Driver's Seat



The driver's seat may be adjusted by moving the seat forward or backward while pulling outward on the lever

Figure 2-11. Driver's Seat

located under the front left portion of the seat. Once the seat is in place, you may

release the lever to secure it.

Adjustments to driver's seats equipped with a lumbar support can be done by pressing the button located on the left underside. To decrease the amount of support, press your back against the seat and press the button. To increase the amount of support, lean forward while pressing the button.

Integral Self Draining Ice Chest

This item is available on most boat models and is located under the seat cushion of the observer's seat. The ice chest drains into the bilge area.

Sundeck

The passenger seats located in the rear of the boat are designed to comfortably seat three persons. Some models are equipped so the bottom seat can be slid forward and placed on top of the armrest to provide a sundeck. On other models the sundeck is built into the storage compartment cover.



Figure 2-12. Sundeck

Warning



The Sundeck is not to be used while the boat is in operation. Serious injuries or death could occur to persons not seated properly should the boat come to an abrupt halt.

V-Drive Engine Access Hatch

An engine access hatch is located behind the rear observers' seat on the V-Drive. Access allows the ability to service engine for required maintenance and for additional storage on both sides of the engine. Your boat battery will be stored in the starboard compartment.



Figure 2-13. Engine Access Hatch

Ski Pylon

The patented, pivoting-head ski pylon is the solid aluminum post located directly in front of the motor box. Minimal maintenance is required, but once a year remove the swivel pylon head and re-grease with a high temperature bearing grease. This will increase use of the pylon and reduce normal wear and tear.

Warning



Malibu Boats' "Pivoting-Head" ski pylon is designed for normal water skiing activities: slalom, jumping, kneeboarding, tricks, and barefooting. Any other uses such as parasailing, kite flying, towing pyramids of skiers, etc., may over-stress the pylon and possibly cause personal injury and/or equipment damage.



Figure 2-14. Pivoting-Head Ski Pylon

Swim Platform

A removable swim step is located at the stern of the boat to provide easy access into and out of the water for both skiers and swimmers. To remove the swim step, simply remove the pins located on each side of the platform and lift upward.



Figure 2-15. Swim Platform



Figure 2-16. Swim Step Pins

Navigational Lights

As required by the U.S. Coast Guard, all recreational vessels are required to display navigational lights between sunset and sunrise and other periods of reduced visibility. All Malibu Boats are equipped with bow and stern navigational lights.

The bow light located at the tip of the bow is two colored -- red and green, and is used to keep others aware of your presence when operating your boat at night.



Figure 2-17. Bow Light

A covered two pronged connector can be found on the top of the transom. The stern light is plugged into this connector when needed and stored under the rear passenger seat when not in use.

Storage Areas

Bow Storage Area

Access to a large storage area located in the bow of all models is accessible by lifting the bottom-lifting strap of the observers' seat back. The size of the storage differs between open and closed bow versions. On all open bow boats, the seat cushions can be removed to provide additional storage.

Gunnel Ski Storage

Conveniently located on both sides of the boat, these storage areas are ideal for the storage of water skis, and other items.

Floor Ski Storage

Located on the floor between the driver's and observer's seats on open bow models with walk-through, is a panel, that when lifted, provides access to a large area that can be used primarily for storage of water skis. This area can also be used to store beverages, if desired.

Transom Storage

Some boat models are equipped with transom ski storage. Depending on the model, the storage is accessible from either the interior by lifting the observer seat or from the transom swim platform by lifting the hatch cover. Most models are equipped with a locking device for the secure storage of your ski items.

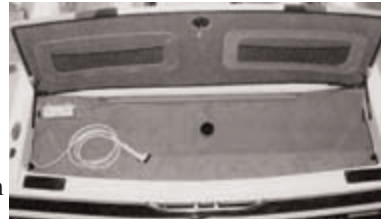

Figure 2-18. Lockable Transom Storage

Drain Plugs



Transom Drain Plug

This plug is located in the center of the transom at the bottom and is provided to allow for drainage of the bilge area when needed.

Figure 2-19. Transom Drain Plug



Bilge Drain Plug

A T-handled brass bilge drain plug is located in the engine compartment of all models except for the Flightcraft Barefooter. To access, lift the

motor box and look aft of the ski tow pylon and forward of the engine. On the Sunseeker VLX the T-handle can be found by lifting the rear passenger just below the V-drive unit.

Figure 2-20. Bilge Drain Plug

Warning



Be sure that both the transom and bilge drain plugs are securely in place before placing the boat in the water.

Speedometer Pickups



to these pickups determines the measured speed of the boat.

The speedometer pickups are located on each side of the boat at the bottom of the transom. The pressure applied

Figure 2-21. Speedometer Pickups

Notice: Clean pickup tubes frequently to keep lake debris from lodging in tubes. Debris can affect accurate reading from speedometer gauges.

Tilt Steering Wheel

The tilt steering wheel allows for maximum driver comfort. To adjust the height of the wheel, simply press down on the lever located under the wheel. Move the wheel to the position that is most comfortable. When the wheel is in the desired position, simply release the lever to lock the wheel in place.



Figure 2-22. Tilt Steering

Figure 2-23. Heater

Figure 2-26. Stereo

Optional Equipment

Heater

If your boat is equipped with a heater, you will find an ON/OFF accessory switch located on the dash panel. Located at the base of the observer seat walkway is a snorkel tube that can be pulled out and directed wherever you like within a five-foot radius. Please refer to the information provided in your owner's packet for specific use.



Bimini Top

For boats equipped with this option, attach the bimini top support legs to the wings on the side of the windshield. Place screw in each wing to hold in place. Attach adjustable strap to the eyelets located in the front and rear of the windshield, and adjust strap for tightness of the canvas.

The bimini top can be stored by releasing the adjustable strap, placing the canvas protective covering over the top, and then folding down the top to the front of the windshield.

For additional installation and assembly instructions, refer to the information that came with the bimini top.

Notice: If the canvas top is wet, allow to air dry before storing to prevent mildew.

Figure 2-29. Pop-Up Cleat



Figure 2-30. Accu-Ski



Figure 2-24. Bimini Top Screw

Figure 2-25. Strap Eyelet

Stereo

The stereo is located under the starboard driver's armrest. To access, simply lift the armrest. To turn on power to the stereo, turn on the power switch located on the dash panel. If your boat is equipped with this option, you can find information on its specific use in the your owners information package.



Hot Water Shower

If your boat is equipped with a hot water shower, you will find an ON/OFF accessory switch located on the dash panel. You will find the valves located on the port side of the motorbox compartment. The shower head can be found in the port gunnel sides. You should find specific instructions on the use of your hot water shower in the packet of materials you received with your boat.



Figure 2-27. Shower Head

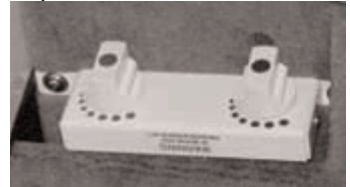

Figure 2-28. Shower Valve

Pop-Up Cleats

Pop-Up cleats are available for all boat models. These cleats will sit flush on the side of the boat deck when depressed. To pop-up the cleats, simply press the screw/button located in the center of the cleat. To depress the cleat, simply press the cleat downward until it locks into place.



Accu-Ski

The optional Accu-Ski system is a speed control unit used to pull skiers with a consistent pull through the ski course. You will find detailed instructions on the use of this option in your boat packet provided with your boat.



Chapter 3

OPERATION



Everyone benefits from the safety of others.

Trailer

The trailering information contained in this section describes general guidelines and procedures used by many boaters. We recommend, in addition, that you always follow the specific information provided by the manufacturer of your trailer.

Load Carrying Capacity

The certification label attached by the manufacturer on the left forward side of the trailer will show the maximum load carrying capacity of the trailer. The label is required to show the Gross Vehicle Weight Rating (GVWR), which is the load carrying capacity plus the weight of the trailer itself. Be sure that the total weight of your boat, gear, and trailer does not exceed the GVWR.

Notice: Consult your trailer dealer for other state regulations concerning brakes, lighting, and other equipment options.

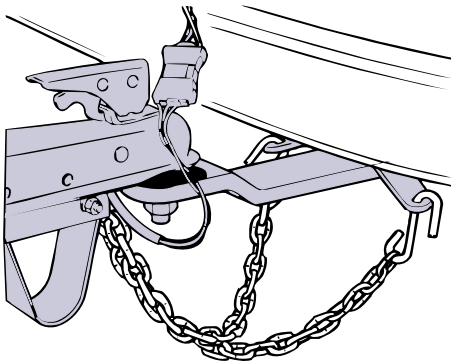

Figure 3-1. Trailer Hitch

KC-1700

class. Always use a hitch with the same class number as the trailer, or greater. Most boat trailers connect to a ball hitch that is bolted or welded to the towing vehicle. Clamp-on bumper hitches are not recommended.

The trailer hitch coupler must match the size of the hitch ball. Never use a hitch ball that does not match the trailer coupler. The correct ball diameter is marked on the trailer coupler.

Hitch

Hitches are divided into classes that specify the gross trailer weight (GTW) and maximum tongue weight for each

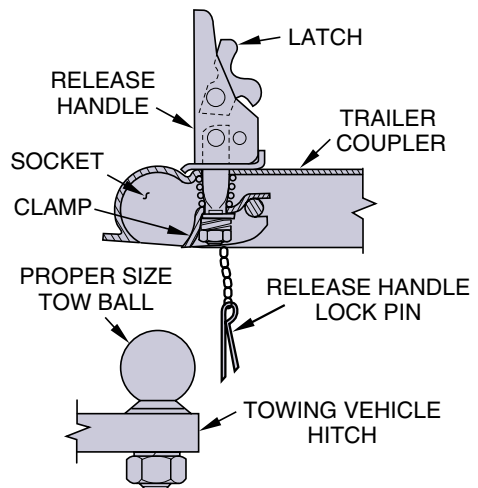

KC-1651

Safety Chains

CRISSCROSS SAFETY CHAINS

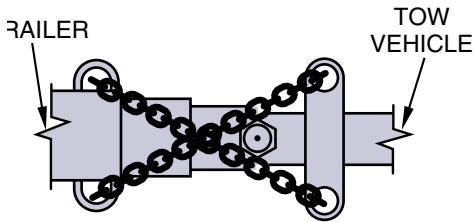

BOTTOM VIEW OF HITCH COUPLING

KC-1691

Figure 3-2. Safety Chains

Tie-Downs

Making sure your boat is held securely in place on the trailer hull supports is extremely important, especially when underway. Regardless of your trailer make or model, there are two key areas to consider:

- **Bow Tie-Downs:** A bow stop to hold the front of your boat in place is located on the winch stand. It should be positioned so that the winch line pulls straight and is parallel to the trailer frame. A separate tie-down should then be attached to hold the boat downward and forward. This may be accomplished by a line from the bow eye to an attachment point on the trailer frame or winch stand.

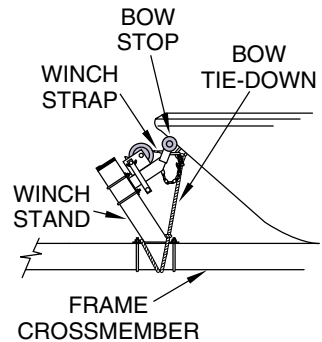

KC-1711.3M

Figure 3-3. Bow Tie-Down

- **Rear Tie-Downs:** It is very important to be sure the transom of your boat is resting fully and securely on the supports provided at the rear of the trailer, and that it remains in place when parked or underway. Special rear tie-downs are available for this purpose. Check often to be sure the rear tie-downs are securely locked in place and tight enough to prevent any movement of the boat.



Figure 3-4. Transom Tie-Down

Backing the Trailer

Backing the boat trailer may sometimes be a difficult task. It is recommended that you practice backing the trailer in a vacant lot or open area before attempting it at a congested boat launch.

Follow these basic rules when backing:

- 1) Turn the front vehicle wheels in the opposite direction in which the trailer is to travel.
- 2) Back vehicle normally once the trailer turn is started.
- 3) Have your vehicle equipped with a right hand mirror, as required by law when towing.

Launching

Following are some helpful tips to assist you with launching your boat:

- Before launching, check the type and condition of the ramp. Ramps are usually made of cement but often times are made of asphalt or even sand. When wet, these ramps can get very slick and can cause additional difficulties when launching your boat.
- Have someone assist you when backing your boat. Back the trailer to the edge of the water and stop. Be sure to properly secure your vehicle.
- Prepare for placing the boat in the water by removing any tie-down straps, disconnecting tail light connections, and attaching a line to the bow eye fitting. If you are using an outboard, be sure that the outboard unit is trimmed up. Be sure to re-install the bilge drain plug if it has been removed.
- To launch, back the trailer into the water to a point where the boat will clear the bottom. Stop and secure the vehicle.
- Unlock the winch line from the boat. Push the boat into the water and have your assistant guide the boat with the bow line.
- Once the boat is cleared of the trailer, pull your vehicle out of the water and park it.

Reloading Procedures

To reload, repeat the unloading procedures in reverse. Other important tips to remember are:

- Try to idle coast onto the trailer; do not power onto the trailer.
 - When pulling the boat onto the trailer, be sure the boat is centered as much as possible. The distance between the boat and runner board should be approximately equal on both sides.
 - Make sure the boat is securely in place before moving the trailer.
-

Fueling

It is very important to take special precautions to avoid spillage while fueling your boat. Gasoline vapors are heavier than air and will develop in the lower cavities of the boat, such as the bilge.

Below is a list of guidelines you should follow when fueling your boat:

- 1) Extinguish all cigarettes and other flame or spark producing items.
- 2) Make sure all power is off, and do not operate any electrical switches.
- 3) Be sure to wipe off any spillage that may have occurred.
- 4) Operate the bilge blower for a minimum of four minutes before starting the engine.

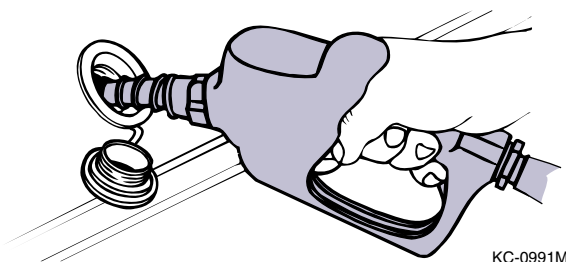

Figure 3-5. Fueling

Starting

Starting procedures will vary depending on the type and model of engine installed in your Malibu. Consult the engine owner's manual for more specific information regarding starting, operation, and troubleshooting for your particular engine.

Pay close attention to the information regarding the break-in period listed in your engine owner's manual. Top engine performance is dependent upon following the guidelines listed.

Pre-Start Checklist

A routine pre-starting procedure should always be carried out before the first start-up of the day. Below is a list of basic, necessary checks to perform before starting your engine.

- 1) Replace drain plugs.
- 2) Check oil and transmission fluid levels.
- 3) Check fuel supply.
- 4) Inspect the engine compartment for water or fuel leaks.
- 5) Operate bilge pump until bilge is dry.
- 6) Operate blower for a minimum of four minutes to expel fumes.

Starting the Engine

Please refer to your engine owner's manual for the proper starting procedures.

Shifting/Running

The throttle lever is located to the right of the driver. When the throttle is vertical, it is in the “NEUTRAL” position.

Located at the base of the throttle you will find the shift lock. Pulling outward on this button disengages the transmission, thereby allowing for use of the throttle without engaging the transmission. This is needed for starting or warm-up of the engine. Be sure to position the throttle vertically (in neutral) before re-engaging the transmission by depressing the button.

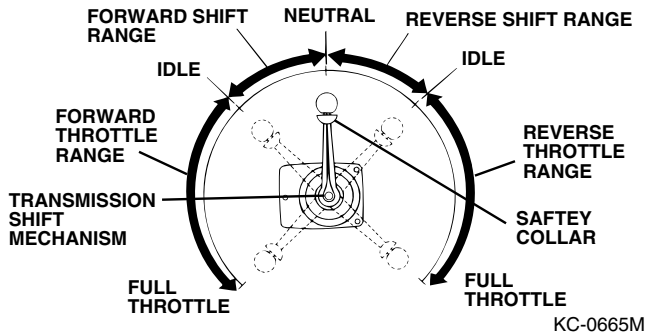

Figure 3-6. Throttle Positions

When engaging the transmission from neutral to either forward or reverse, you must pull up on the safety collar located directly below the throttle lever knob.

Notice: For more information regarding the safe operation and maintenance of the throttle control, refer to the separate instructions located in the information packet shipped with your boat.

Steering

It is important that you get the “feel” of your boat’s steering system. Turn the wheel from full left to full right, and make sure the rudder is turning accordingly. The system should operate freely and smoothly.

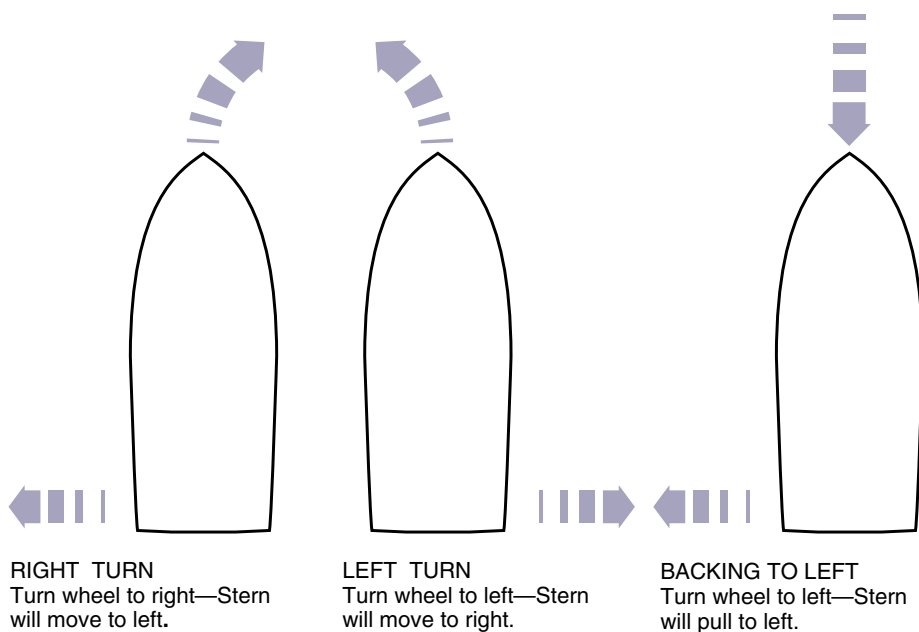

KC-1071R

Figure 3-7. Turning With A Rudder

Warning



The steering system must be in good operating condition for safe boat operation. Frequent inspection, lubrication, and adjustment by your dealer is recommended.

All boats have a tendency to wander somewhat at slow speeds. A natural reaction to this effect is to steer the boat back and forth in an attempt to compensate for wandering. Invariably, the compensation will result in oversteer and only worsen the effect. Keep the steering wheel in the center position, the boat will wander back and forth somewhat, but the overall course will be a straight one.

Maneuvering Techniques

Steering response depends on three factors: engine position, motion and throttle.

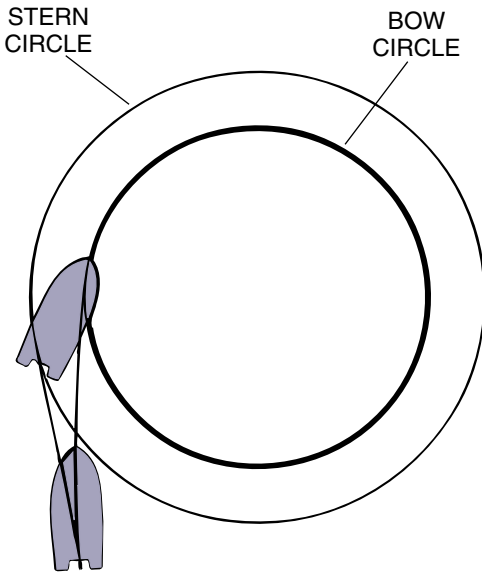

KC-1470

Figure 3-8. Stern Push

aspect shared by all single engine propeller-driven watercraft. A clockwise rotation propeller tends to cause the boat, steering in the straight ahead position, to drift to starboard when going forward, and to port when going backward. At high speed, this effect is usually unnoticed, but at slow speed; especially during backing, it can be powerful. For this reason, many veteran boaters approach the dock with the port side of the boat toward the dock, if possible.

Like an automobile, high speed maneuvering is relatively easy and takes little practice to learn. Slow speed maneuvering, on the other hand, is far more difficult and requires time and practice to master.

When making tight maneuvers, it is important to understand the effects of turning. Since both thrust and steering are at the stern of the boat, the stern will push away from the direction of the turn. The bow follows a smaller turning circle than the stern.

The effects of unequal propeller thrust, wind, and current must also be kept in mind. While wind and current may not always be present, an experienced boater will use them to his advantage. Unequal thrust is an

Stopping

When stopping the boat, it is important to remember there are no brakes to allow coming to a complete, immediate stop. To stop your boat, anticipate ahead of time and begin slowing down by pulling back on the throttle.

Once the throttle is in neutral and the engine has stopped pulling the boat forward, it may be necessary to pull the throttle into reverse to further slow the forward momentum of the boat. The reverse thrust of the engine will decrease the forward speed and slow the boat down to a safer maneuvering speed.

Warning



Do not use the engine stop switch for normal shut down. Doing so may impair your ability to re-start the engine quickly or may create a hazardous swamping condition.

Docking

Docking procedures for the new boat owner usually bring surprising results. Remember, operate your boat at slow speeds to avoid accidents and practice docking to gain experience and confidence.

Once away from the dock, practice docking in open water with an imaginary dock. Pull up to the dock at a slow rate of speed. Shift the boat into neutral and drift slowly toward the dock. Shift the boat into reverse slightly to slow or stop the boat altogether.

Warning



Never use your hand, arm or other part of your body to attempt to keep the boat from hitting the dock. The boat could push against the dock, causing severe injury.

Follow these guidelines when docking:

- Approach docks with the starboard side of the boat if possible.
- Come to a stop a short distance from the dock, then proceed slowly.
- Have fenders, mooring lines and crew ready.
- Observe how the wind and current are moving your boat. Approach the dock with the boat pointed into the wind, if possible. If the wind or current is pushing you away from the dock, use a sharper angle of approach. If you must approach the dock downwind or down current, use a slow speed and shallow angle. Be ready to reverse to stop and maintain position.
- If there is no wind or current, approach the dock at a 10 to 20 degree angle.
- If possible, throw a line to a person on the dock and have that person secure a bow line.
- With the bow secure, swing the stern in with the engine, or pull it in with a boat hook.

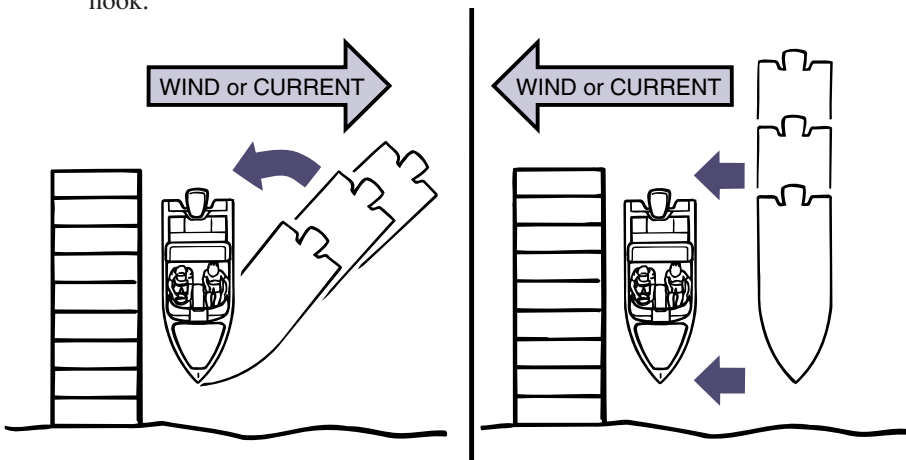

KC-1120

Figure 3-9. Docking With Wind/Current

Before tying-up the boat, be sure to use enough fenders to protect the boat from damage. If possible, tie-up with the bow towards the waves with a good quality double-braided nylon line. Tie-up only to the lifting or tie-down eyes; never use the handrails or windshield frames. If the boat is to be moored for a long period of time, use chafing protectors on lines to protect the gelcoat finish. Leave a little slack in the lines to allow for some wave movement or tidal action if applicable.

Follow these guidelines when departing:

- Very slowly shift into forward at idle speed.
- When the stern moves away from the dock, turn the engine away from the dock.
- Cast off bow line and back away.

If the wind or current is pushing away from the dock, cast off all lines and allow to drift until you are clear.

High Speed Operation

A great deal of caution must be exercised when operating any boat at high speeds. This is particularly true during turns. Gradual turns can be completed at high speed by a competent driver, but it must be emphasized that sudden turns at any speed, particularly at high speed can be especially dangerous. It is possible to throw passengers from their seats and even from the boat if caution is not exercised.

Trimming

Available in the Flightcraft Outboard only, the trim changes the drive unit angle in reference to the transom of the boat and can be adjusted on the switch located next to the driver in front of the throttle. The drive unit should be fully lowered prior to initial acceleration. After the boat has attained planing speed, the drive unit should be raised as necessary for maximum speed and handling. If the drive unit is raised too high, porpoising, cavitation, or propeller slippage can occur. Adjustments to the trim angle should be made as speed and attitude of the boat changes.

If the engine is trimmed in too far (closer to the boat bottom), speed drops, fuel economy decreases, and the boat may not handle correctly. However, it does provide better acceleration from a stand still; and because it forces the bow down, visibility is improved. If the engine is trimmed out too far (away from the boat bottom), steering torque may increase, the boat may be difficult to get on a plane, and may bounce.

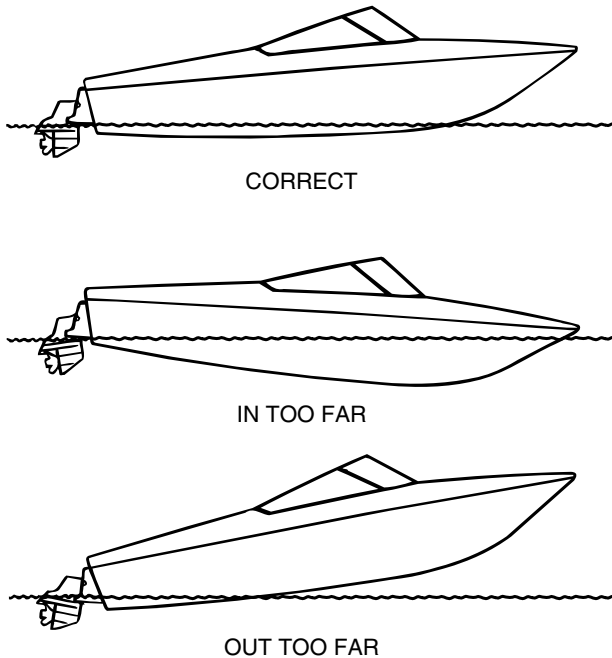

KC-1150M

Figure 3-10. Boat Trim

Towing a Skier

Water skiing is a collective effort involving driver, observer and skier. The degree of understanding and cooperation between them directly determines the success and enjoyment of the venture. All must understand that the skier is an extension of the boat. The driver is no longer responsible for a boat that is 20 feet long, but closer to 95 feet. Once this is understood, you are underway to a safe and secure adventure together. A healthy respect for Common Sense Rules of waterskiing safety on the part of the skier, driver and observer will ensure the risk of skiing accidents is kept to a minimum at all levels of participation.

A moderate ability to swim is advisable for waterskiers, but swimming ability is no substitute for a well-fitting life jacket. The wearing of a life jacket or personal floatation device (PFD) is essential even for expert swimmers. The jacket should be Type III, approved by the U.S. Coast Guard and designated as a ski jacket. The jacket should fit snugly, otherwise it could slip up over the skier if the skier should happen to fall at high speed.

Communication between the skier and driver is essential. Standard signals have been developed by the American Waterski Association and have been accepted by most waterskiers. Once the skier is in the water and ready, the driver of the boat will take the slack out of the tow line. When the skier is in position and prepared for lift, the skier shouts “hit it” which is the signal for the driver to open the throttle for take-off. Once the skier is on plane, there are a number of hand signals that will allow communication between the skier and the driver of the boat. A copy of these signals can be found for review at your local Malibu dealership or by contacting the American Waterski Association at (813) 324-4341.

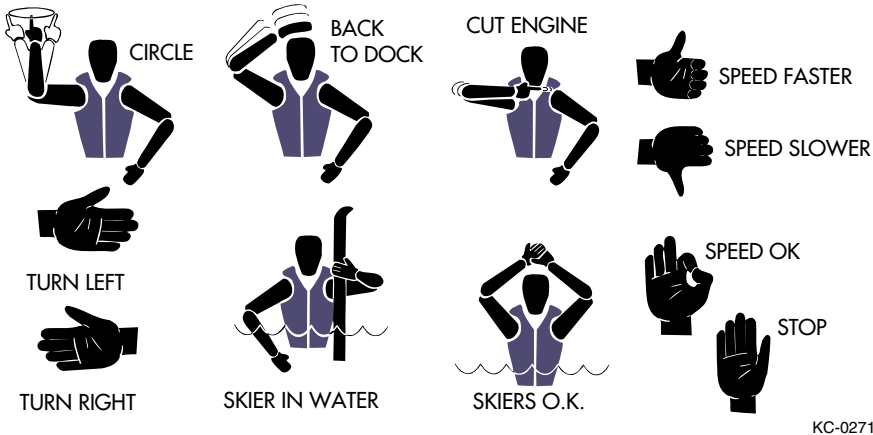
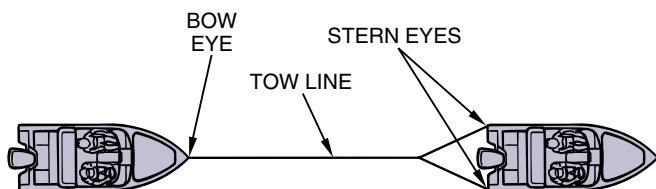

Figure 3-11. Hand Signals

Once a skier has fallen or is ready to quit skiing, the driver must be prepared for immediate removal of the skier from the water. The driver of the boat should keep the skier in line of sight as much as possible until the skier is reached. Once the boat is up to the skier, the driver should always turn off the engine until the skier is onboard. There should be no exception to this rule as there is always the possibility of the skier slipping or falling back into the water risking contact with the boat propeller.

Towing Another Boat

Towing is normally a last resort because damage can be created by stress from the towing lines or uncontrollability of the boat being towed. Only when ideal conditions arise; lake is calm, the disabled boat is smaller than yours, and both boat operators know correct technique, should a recreational boat be towed by another.



KC-2111M

Figure 3-12. Towing

Because the towing boat is the maneuverable boat and the grounded boat is not, you should pass the tow line to the grounded boat. Use double-braided line. Never use three strand twisted nylon; it has too much elasticity and can snap back dangerously. Fasten the towline as far forward as possible on the upwind or up current side of the boat being towed. Fastening it to the stern will restrict maneuverability. Attach the line to the stern lifting eyes of the towing boat. Keep lines free of propellers on both boats. Keep hands and feet clear of other boat and never hold towline after it is pulled taut.

Move slowly to prevent sudden strain on slack line.

Be ready to cast loose or cut the line if conditions become hazardous.

Anchoring

There are many types of anchors available on the market. The choice on which one to choose depends on the usage. Contact your dealer on what anchor would suite your situation.

Warning



Always anchor from the bow of the boat. The boat has less chance of breaking free if a heavy wind comes.

Propellers

Nothing is more important to the proper performance of your boat than the condition of the propeller. Even slight propeller damage can mean the loss of one MPH. Greater damage can mean considerably more speed loss. Worse yet, damage usually is not done to each blade uniformly and, therefore, sets up imbalanced vibrations that can cause fatigue damage to other parts of the engine or drive system.

Your propeller is custom calibrated for your Malibu by our Research and Design team to give maximum performance. Before installing props other than those suggested by Malibu contact your dealer, otherwise adverse handling and top speed characteristics may be experienced.

The prop is identified by two numbers, i.e., 13 x 14, and material identification such as brass or stainless steel. The first number is the diameter of the prop and the second is the pitch. The pitch is the angle of the blades and is measured in how far the boat will travel through the water in one revolution. In this case, for every one revolution the boat will travel 14 inches.

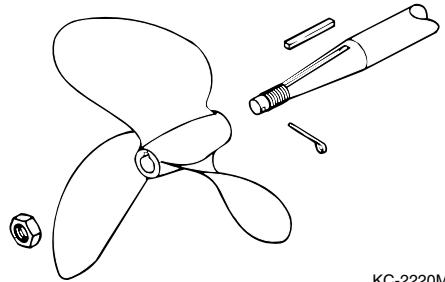

KC-2220M

Figure 3-13. Propeller

Warning



Do not operate engine above the manufacturer's recommended RPM rating; severe damage could result, voiding the warranty.

At least once a year, more often if you use your boat extensively, you should have your local Malibu dealer inspect the propeller for any possible damage.

At least once a month, if you use your boat regularly, you should check and tighten the prop nut. If it is necessary to remove the prop, use care. If the prop is not removed correctly, damage could result if it comes off the shaft too quickly and hits the ground. Whenever possible, use a prop pulling tool to remove prop, this will reduce the chance of damaging the prop.

Corrosion Protection

Galvanic corrosion (electrolysis), is the break-up of metals due to the effects of electrolytic action. When two dissimilar metals are immersed in a conductive fluid such as salt water, an electric current is produced, similar to that of a battery. As the current flows, it takes with it tiny bits of the softer metal. If not stopped, a great deal of damage can occur.

If you operate your boat in salt or brackish waters, you should have your boat equipped with a transom mounted zinc anode to prevent damage to the parts coming in contact with the water. The zinc anode being the softer metal will deteriorate and erode much faster than the other metals in the boat. Inspect the anode periodically and replace as needed. Consult your local Malibu dealer for this part.

Salt Water Corrosion

The entire boat should be rinsed with fresh water immediately after use in salt water. If the boat is used primarily in salt water, wash the hull monthly and apply corrosion inhibitor to all hardware. See your dealer for products suitable for the marine salt-water environment. Fresh water internal flushing is recommended when used in salt, polluted or brackish waters. Flush the entire cooling system with fresh water for at least five minutes after use in these waters. See your Malibu dealer for appropriate flushing devices.

- 2) Wax the boat hull and deck after every three or four outings to decrease water friction and to lessen the potential for staining or spotting the gelcoat surface. In cases where the original gelcoat shine cannot be restored by waxing, hand buff the surface using any commercial compound. Be sure to apply several coats of wax over the area that has been polished.

Surface Stains

Stains can appear as a result of dust, road tar, plant sap, rust from metal fittings, and other materials coming in contact with your boat's exterior. Listed below is a step-by-step procedure to remove stains from your boat:

- 1) Wash area with dish washing soap
- 2) Apply a mild cleanser on a small area (3 x 3 feet)
- 3) Rinse with fresh water
- 4) Buff with a fine rubbing compound
- 5) Wax

If the stain is not removed by the dish washing soap or mild cleanser, then the next procedure is to use either denatured or rubbing alcohol. Common rubbing alcohol is excellent for removing stains.

Scratches

Scratches to the gelcoat sometimes occur during normal use. Your dealer can usually restore the gelcoat to like-new condition.

Underwater Corrosion

Corrosion occurs in saltwater conditions from the interaction of the saltwater and the direct current of the battery. To prevent corrosion, it is important to keep the bilge area as dry and clean as possible.

Care For Boats That Are Moored

Due to gelcoat discoloration, osmosis (blistering), and algae growth, it is not recommended that you leave your boat moored for long periods of time. If your boat will be moored in fresh water or saltwater for extended periods of time, you should do the following:

- 1) Haul-out and clean your boat regularly (every 14 to 21 days). Use soap, water, and plenty of elbow grease.
- 2) Apply wax after cleaning.

You should also check with your local Malibu dealer about anti-fouling paint and other products that can be applied to the hull bottom below the water line.

Teak

Care must be taken to keep teak wood from turning gray or rough. The roughing becomes more apparent as the moisture evaporates and dries out.

It is suggested that you use teak or mineral oil treatments at least four times a year to maintain the appearance of your swim platform. Use a high quality teak oil which can be purchased at your local Malibu dealership.

Notice: Teak wood should never be varnished.

Electrical

Battery

Your Malibu boat is equipped with a standard 12-volt battery. The battery comes with a non-metallic box to help contain spills and prevent corrosion.

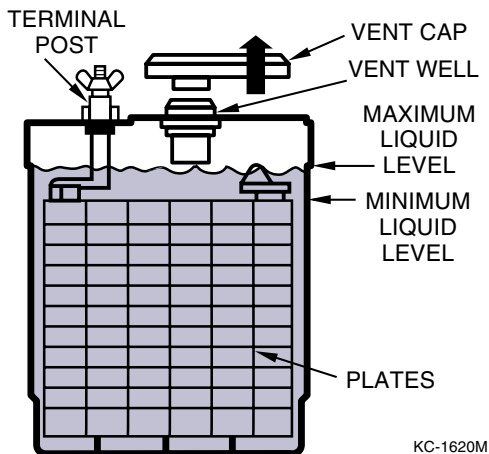

Figure 4-1. Battery Level

Check your battery terminals frequently for corrosion and tightness. Clean terminals with a baking soda and water solution and a wire brush. Also, check the fluid levels in the cells. Usually, a level approximately 1/4 to 1/2 inch above the plates is sufficient. If needed, fill with distilled water. Some batteries are sealed and this process is not necessary. Read directions when applicable.

Battery Isolator Switch

This option provides the ability to isolate the boat batteries if more than one battery is used. If so equipped, the isolator switch is located behind the front observer's seat under the dash next to the battery. Under normal situations, the switch should be in "POSITION 1" or "POSITION 2" rather than in the "ALL" position. This will keep one battery charged should one of the batteries fail.

Circuit Breakers and Fuses

Most electrical standard equipment devices are controlled with circuit breakers. These breakers will activate if overloaded and cut power to the switch. To restore power, simply push the breaker button in and release. Breakers do not require fuse replacement. The breaker panel can be found under the dash next to the 12-volt adapter. The stereo, if so equipped, has an inline fuse. If your stereo should quit working, check fuse as well as the breaker.

12-Volt DC Accessory Outlets

All models except Sportster and Flightcraft are equipped with two 12-volt DC Accessory Outlets; one on the electrical panel below the dash, and one in the glove box. These outlets provide power from your boat battery to accessory equipment such as cellular phones, video cameras, marine spot lights, etc. Sportster and Flightcraft models do not have the extra glove box outlet.

Troubleshooting

The following charts will assist you in finding and correcting minor mechanical and electrical problems with your boat. Problems are listed in the order of the most likely event to the least likely.

To correct a problem, first determine what the problem is. Start with the first cause and eliminate the possibility of each until the problem is corrected. Because of the specialized skills and tools needed to correct major issues, we have not included that information. If you suspect a problem not listed here, please contact your Malibu dealer.

PROBLEM	POSSIBLE CAUSE	SOLUTION
Engine will not turn over	<ul style="list-style-type: none"> • Safety lanyard not connected. • Throttle control in gear. • Main circuit breaker open. 	<ul style="list-style-type: none"> • Connect safety lanyard. • Shift into neutral. • Re-Set circuit breaker.
Engine turns over, but will not start	<ul style="list-style-type: none"> • Stop switch not set. • No fuel to engine. • No fuel in tanks. • Fuel filter clogged. • Contaminated fuel. • Distributor problems. 	<ul style="list-style-type: none"> • Reset switch. • Turn fuel valve to ON. • Fill fuel tank. • Replace fuel filter. • Replace fuel and filter. • See your dealer.
Engine is hard to start	<ul style="list-style-type: none"> • Flooded engine. • Plugged flame arrestor. • Fouled spark plugs. • Loose coil or ignition wires. • Battery cables loose or corroded. • Weak battery. • Ignition problems. 	<ul style="list-style-type: none"> • Start engine full throttle and back off. • Clean flame arrestor. • Replace spark plugs. • Tighten coil or ignition wires. • Clean and tighten battery cables. • Charge or replace the battery. • See your dealer.
Engine misses or idles rough	<ul style="list-style-type: none"> • Fouled spark plugs. • Loose or defective high-tension leads. • Plugged PVC valve. • Weak ignition coil. • Vacuum leak. 	<ul style="list-style-type: none"> • Replace spark plugs. • Tight or replace the high-tension leads. • Replace PVC valve. • Replace ignition coil. • See your dealer.

PROBLEM	POSSIBLE CAUSE	SOLUTION
No speedometer	<ul style="list-style-type: none">• Disconnected, kinked or plugged tubing.• Plugged pitot pickup.• Defective pitot pickup.• Defective speedometer.	<ul style="list-style-type: none">• Repair or replace the tubing.• Remove objects from the pickup.• Replace pitot pickup.• Replace the speedometer.
Incorrect speedometer	<ul style="list-style-type: none">• Blocked pitot tube.• Water in tubing.• Defective speedometer.	<ul style="list-style-type: none">• Remove the blockage.• Disconnect the tubing at the speedometer and blow out the tubing. Tighten nut finger snug, then 1/4 turn more.• Replace the speedometer.

To validate this warranty, it is the responsibility of the original Retail Purchaser to complete and return a warranty registration card within 1 days of the retail purchase date to:

Malibu Boats West, Inc., One Malibu Court, Merced, CA 95340

Warranty repairs will be performed at an authorized Malibu dealer or the manufacturers location provided that transportation costs for both direction are prepaid and the claim is made within sixty (60) days after the defect is discovered. Notification of a claim or defect can be made through the selling dealer or by writing directly to Malibu Boats. Information needed for processing a claim includes: name and address of original retail purchaser, boat serial number (embossed on the upper right side of the transom), original retail purchase date, a detailed explanation of the defect and a estimated repair cost. Warranty repair or replacement can only be made after Malibu Boats approves the above information. If approved, a warranty authorization number will be issued in writing or by telephone to the approved warranty repair station.

This limited warranty is given in place of and instead of any and all express or implied warranties, and may not be modified in whole or in part by anyone other than Malibu Boats.

Some states do not allow a limitation on how long an implied warranty lasts or the exclusion or limitation of incidental or consequential damages therefore, these limitations may not apply to you. This warranty gives you specific legal rights and you may also have other rights that vary from state to state.

Malibu Boats West, Inc., One Malibu Court, Merced, CA 95340

Phone: (209) 383-7469, Fax: (209) 383-0499.

Effective: 2000 Boat Models.

Other Manufacturer Warranties

Along with Malibu's warranty policy, many of the components used to build your Malibu boat are covered by individual warranties from their respective manufacturers. These products all have specific warranty periods and conditions that you should be familiar with should you need assistance. Included in the information packet shipped with your boat you will find information regarding any individual manufacturer's warranty policies for the different equipment installed on your boat. We strongly advise you to make yourself familiar with the different warranties offered before contacting the vendor.

Owner Service Assistance

Problem Resolution

Everyone associated with Malibu Boats is highly concerned with your complete and total satisfaction. Included in this concern is the prompt resolution of any problems that may occur during the life of your Malibu boat. Under almost all conditions, most problems can be adequately resolved by your local Malibu dealer. However, if a problem arises and cannot be handled by your dealer or for which the solution is unsatisfactory to the owner,

Glossary

AFT:	To the rear of the boat near the stern. Generally used to give directions.
BEAM:	The widest portion of the hull.
BILGE:	The lowest portion inside the boat. This is generally the section directly below the engine compartment.
BOW:	The forward portion of the boat.
BULKHEAD:	Vertical portion in a boat.
CHINE:	The intersection of the sides and bottom of a “V” bottom boat.
DEADRISE:	The degree of angle from the keel to the chine.
DECK:	Upper structure which covers the hull.
DRAFT:	Vertical distance from the waterline of the boat to the lowest part of the boat.
FibECS II:	An engine mounting method using fiberglass instead of aluminum, patented by Malibu Boats West, Inc., that provides for major reductions in noise and vibration found on all other inboard boats.
FIBERGLASS:	Fibers similar to wool or cotton, but made from fibrous glass. Glass fiber forms include cloth, yarn, mat, milled fibers, chopped strands, roving, and woven roving.
GELCOAT:	A surface, either colored or clear, providing a cosmetic enhancement and exposure improvements to a fiberglass laminate.
GUNNEL:	The upper edge of a boat’s side.
HELM:	Device attached to rudder for steering a vessel.
HULL:	The bottom section of the boat.
KEEL:	The lowest most portion of the bottom of the boat.
LIFTING STRAKES:	Strips molded or attached to the surface of a hull designed to create lift as speed and pressure increase with the static water.
PORT:	To the left side of the boat, when facing the bow.
STARBOARD:	To the right side of the boat, when facing the bow.
STERN:	To the rear of the boat.
STRINGER:	Longitudinal members that are fastened inside the hull of the boat which provide structural integrity.
TRANSOM:	The area forming the stern, or rear, of a boat.
WAKE:	The track or path a boat leaves behind while in motion.

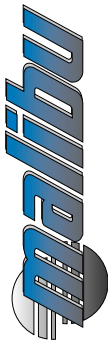

Maintenance Worksheet

Please circle one- Pre-delivery-/10hr.-/50hr.-/100hr.-/Annual

HULL NUMBER	OWNER NAME	PHONE NO.
-------------	------------	-----------

SERVICE DATE	WORK ORDER #	BOAT COLOR	SERVICE TECHNICIAN
--------------	--------------	------------	--------------------

INSTRUCTIONS

Please complete following, check each item as completed

- ___ 1. Inspect prop
- ___ 2. Check engine alignment, motor mounts, and jam nuts
- ___ 3. Check shaft packing
- ___ 4. Service rudder (Lubrication)
- ___ 5. Check battery, battery hold down, cable connections
- ___ 6. Check instrumentation
- ___ 7. Check lanyard switch operation (kill switch)
- ___ 8. Check lights (bow, stern, and dash)
- ___ 9. Check steering wheel cable fasteners, lubricate support tube and cable
- ___ 10. Check control mechanism MV-2, MV-3 (freedom of movement)
- ___ 11. Check neutral safety switch operation
- ___ 12. Check security of fasteners (seat slides, seats, platform, interior handles)
- ___ 13. Check all fuel connections (engine, tank, pump, filter)
- ___ 14. Check engine exhaust clamps
- ___ 15. Change engine oil and filter
- ___ 16. Change transmission fluid/ filter
- ___ 17. Change V-drive oil (clean screens / magnetic plugs)
- ___ 18. Change fuel filters (engine / tank)
- ___ 19. Inspect belts
- ___ 20. Inspect impeller
- ___ 21. Clean / change flame arrestor
- ___ 22. Check engine coolant (closed cooling only)
- ___ 23. Check trailer: wheel lugs, lights, and loading bar
- ___ 24. Inspect and lubricate wheel bearings
- ___ 25. Check brake fluid level (if applicable)

- ___ 1. Perform TECH I data list scan
- ___ 2. Check PROM ID and record in customer file
- ___ 3. Check engine timing (in service mode)
- ___ 4. Check fuel pressure and log reading
- ___ 5. Verify oil levels (engine, Trans, v-drive)
- ___ 6. Verify blower operation, check hose attachment
- ___ 7. Verify bilge pump operation and float control
- ___ 8. Check for engine / boat water leaks
- ___ 9. RE-check fuel connections
- ___ 10. Verify neutral safety switch operation
- ___ 11. Check for presence of vibration
- ___ 12. Verify lanyard switch operation (kill switch)
- ___ 13. Verify instruments operate properly
- ___ 14. Verify controls operate properly (IE; steering, shifter)
- ___ 15. Verify options function properly(IE; heater, shower etc.)

I certify that all checks have been performed and completed, this vessel has been prepared in conjunction with Malibu Boats specifications.

To ensure proper warranty status, Boat/ Engine MUST receive Recommended maintenance schedule

Technician Signature _____ Date _____

Service Contact _____ Phone _____

Customer Signature _____

PLEASE RETAIN IN CUSTOMER FILE FOR FUTURE REFERENCE

LAKE TEST



Corporate Headquarters

Malibu Boats
One Malibu Court
Merced, CA 95340
Phone: (209) 383-7469
Fax: (209) 383-0499

Tennessee Plant

Malibu Boats
5075 Kimberly Way
Loudon, TN 37774
Phone: (423) 458-5478
Fax: (423) 458-9052

Australian Headquarters

Malibu Boats
813 Hope Court
Albury, N.S.W. 2640
Phone: 026 040 1174
Fax: 026 040 4656

Internet:

www.malibuboats.com
info@malibuboats.com