

AXIS OWNER'S MANUAL
WAKE RESEARCH



All information and specifications included in this manual were in effect at the time of approval for printing. Axis Wake Research reserves the right, however, to discontinue or change specifications or design at any time without notice and without incurring any obligation.

Trademarks

Axis Wake Research and The Axis Logo are registered trademarks of Axis Wake Research.

Indmar is a registered trademark of Indmar Products Co., Inc.

All other product names are copyright and registered trademarks/trade names of their respective owners.

© 2009-2011 Axis Wake Research
All Rights reserved.
Printed in the USA

Notes

CONTENTS

CONTENTS	iii	Drain Plugs	2-12
TABLE OF FIGURES	iv	Speedometer Pickup	2-12
INTRODUCTION	v	Tilt Steering Wheel	2-13
CERTIFICATIONS & STANDARDS ..	v	Exhaust	2-13
MODEL FEATURES & SPECIFICATIONS	vii	Ventilation	2-14
BOATING SAFETY	1-1	Optional Equipment	2-15
General Precautions	1-1	Wedge	2-17
Safety Statements	1-2	OPERATION	3-1
Regulations	1-3	Trailerling	3-1
Responsibilities	1-3	Warning Labels	3-4
Emergencies	1-6	Fueling	3-7
Hazardous Conditions	1-7	Starting	3-8
Carbon Monoxide	1-8	Shifting/Running	3-10
Operation by Minors	1-9	Steering	3-11
Passenger Safety	1-9	Stopping	3-12
Basic Rules of the Road	1-9	Docking	3-13
GAUGES & CONTROLS	2-1	High-Speed Operation	3-14
Standard Gauges	2-1	Towing / Interacting with Skiers, Wakeboarders and Wake Surfers	3-14
Circuit Breakers	2-4	Towing Another Boat	3-16
Switches & Indicators	2-4	Anchoring	3-16
Throttle Control	2-6	Propellers	3-17
Steering System	2-7	Axis Exclusive Adjustable Rudder System	3-19
Emergency Engine Stop Switch ..	2-7	Corrosion Protection	3-20
Motorbox Cover	2-7	CARE AND MAINTENANCE	4-1
Driver's Seat	2-8	Interior	4-1
Sundeck	2-9	Exterior	4-3
V-Drive Engine Access Hatch	2-9	Engine/Drive Train	4-4
Ski Pylon	2-9	Fuel System	4-8
Swim Platform	2-10	Electrical	4-9
Navigational Lights	2-10	Miscellaneous	4-12
Storage Areas	2-11	Troubleshooting	4-15
		Glossary	4-18
		Index	4-19
		WARRANTY	W-1

TABLE OF FIGURES

Figure 1-1 Personal Flotation Devices	1-5	Figure 2-24 Tilt Steering	2-13
Figure 1-2 Fire Extinguisher	1-6	Figure 2-25 Heater	2-15
Figure 1-3 Weather Hazards	1-7	Figure 2-26 Boat Cover	2-15
Figure 1-4 Diver Down Flag	1-7	Figure 2-27 Pull-Up Cleat	2-16
Figure 1-5 Carbon Monoxide Hazards	1-9	Figure 2-28 FatAX	2-16
Figure 1-6 Types of Buoys	1-10	Figure 2-29 Wedge Down	2-17
Figure 1-7 Mooring Buoys	1-10	Figure 2-30 Wedge Up	2-17
Figure 1-8 Regulatory Markers	1-10	Figure 3-1 Trailer Hitch	3-1
Figure 1-9 Crossing Situation	1-11	Figure 3-2 Safety Chains	3-2
Figure 1-10 Overtaking Another Craft	1-12	Figure 3-3 Bow Tie-Down	3-2
Figure 2-1 Graphical Display	2-1	Figure 3-4 Transom Tie-Down	3-2
Figure 2-2 Tachometer	2-2	Figure 3-5 Warning Labels	3-4
Figure 2-3 Speedometer	2-3	Figure 3-6 Sample Capacity Plate	3-6
Figure 2-4 Circuit Breaker Panels	2-4	Figure 3-7 Fueling	3-7
Figure 2-5 Accessory Switch Panel	2-4	Figure 3-8 Throttle Positions	3-10
Figure 2-6 Inline Fuse	2-5	Figure 3-9 Turning with a Rudder	3-11
Figure 2-7 Throttle	2-6	Figure 3-10 Stern Push	3-12
Figure 2-8 Emergency Engine Stop Switch	2-7	Figure 3-11 Docking with Wind/Current	3-13
Figure 2-9 Motorbox	2-7	Figure 3-12 Hand Signals	3-15
Figure 2-10 Bolster Seat	2-8	Figure 3-13 Towing	3-16
Figure 2-11 Seat Adjuster	2-8	Figure 3-14 Propeller	3-17
Figure 2-12 Sundeck	2-9	Figure 3-15 Adjustable Rudder	3-19
Figure 2-13 Engine Access Hatch	2-9	Figure 4-1 AR335 MPI Engine	4-4
Figure 2-14 Pivoting-head Ski Pylon	2-9	Figure 4-2 Typical Transmission Dipstick	4-6
Figure 2-15 Swim Platform	2-10	Figure 4-3 Dripless Shaft Seal	4-7
Figure 2-16 Swim Platform Pins	2-10	Figure 4-4 Main Circuit Breaker	4-9
Figure 2-17 Bow Light	2-10	Figure 4-5 Battery Level	4-10
Figure 2-18 Transom Storage	2-11	Figure 4-6 Battery Switch	4-11
Figure 2-19 Bow Storage	2-11		
Figure 2-20 Glove Box Storage	2-11		
Figure 2-21 Transom Drain Plug	2-12		
Figure 2-22 Bilge Drain Plug	2-12		
Figure 2-23 Thru-Hull Paddle Wheel Pickup	2-12		

INTRODUCTION

Axis Wake Research manufactures high-performance wakeboard boats and brings new levels of quality, performance and style to the entry-level boat market with unparalleled pride of ownership.

Axis raises performance and customer satisfaction levels in this market segment through an aggressive grassroots research and development campaign. These efforts revolve around the specific needs and wants of core riders and families alike, or as the team at Axis Wake Research likes to say and the Axis name implies, “We’re centered on you.”

This manual has been assembled to help you operate your new Axis with safety and pleasure. Details of typical equipment as well as recommended safety and maintenance procedures about your boat are supplied. Please read carefully and familiarize yourself with the craft before using it.

We at Axis Wake Research thank you for choosing us as your boat manufacturer and assure you that your satisfaction and boating enjoyment will continue to be our #1 priority.

CERTIFICATIONS & STANDARDS

NMMA Certification

Your Axis boat has been built to meet or exceed the standards set by the National Marine Manufacturers Association (NMMA). NMMA verifies annually, or whenever a new boat model is introduced, to determine that they meet not only Coast Guard regulations, but also the more comprehensive standards set by the American Boat & Yacht Council (ABYC).

Standards to Which This Boat was Built

Your Axis boat was built with the utmost care throughout the complete manufacturing process. The deck, hull, stringers and floor, as well as many accessory components, were built using our hand-laid composite fiberglass scheduling techniques. All boats receive complete quality control checks. Each boat is lake tested, and all information is kept on file at our factory for future reference.

Exemption Notice

This boat complies with U.S. Coast Guard safety standards in effect on the date of certification with the exception of certain fuel systems requirements associated with its fuel injected engine as authorized by U.S. Coast Guard Grant of Exemption (CGB-06-005). Maintenance of the fuel system in this boat should be performed only by Axis Wake Research trained certified technicians using identical fuel system components.

Hull Identification Number (HIN)

Your Hull Identification Number can be found on the starboard transom of your boat below the rubber rub rail. Federal law prohibits the tampering or removing of the number in any way. Use this number to register your boat with your local and state authorities.

US AWRXXXXXA001

Proposition 65

Warning



A wide variety of components used on this vessel contains or emits chemicals known to the state of California to cause cancer, birth defects and other reproductive harm.

EXAMPLES INCLUDE:

- Engine and generator exhaust
- Engine and generator fuel, and other liquids such as coolants and oil, especially used motor oil
- Cooking fuels
- Cleaners, paints and substances used for vessel repair
- Waste materials that result from wear of vessel components
- Lead from battery terminals and from other sources such as ballast or fishing sinkers

TO AVOID HARM:

- Keep away from engine, generator and cooking fuel exhaust fumes.
- Wash areas thoroughly with soap and water after handling the substances above.

Emission Control Warranty Information

The engine in your boat meets the strict requirements set forth by the California Air Resources Board (CARB). The engine has a special environmental tag and the boat has this label affixed to it. The tag and the label are required by the California Air Resources Board (CARB). The label has 1, 2, 3 or 4 stars. The label MUST be affixed to the boat, if the boat is operated in the state of California and/or bordering waters.



MODEL FEATURES & SPECIFICATIONS

AXIS A20 SPECIFICATIONS



A top-down view of the Axis A20 boat deck. The deck is white with a red hull. Various components are marked with orange callout points labeled A through I. A central console with a seat and engine is visible. The deck has a transom at the rear and a bow at the front.

- A. Bow Light
- B. Chillax Seat (optional)
- C. Glovebox
- D. Battery Location
- E. Under Seat Storage
- F. Skybox Slide Seating
- G. Storage Area
- H. Transom Grab Handle
- I. Above Engine Storage

Length: 20' | Beam: 98"
Draft: 27" | Weight: 3200 lbs
Fuel Cap: 48 gal | Seating Cap: 11
Std Engine: AR335
Std Prop: ACME 13.5x16

AXIS A22 SPECIFICATIONS



- A. Bow Light
- B. Chillax Seat (optional)
- C. Glovebox
- D. Battery Location
- E. Under Seat Storage
- F. Skybox Slide Seating
- G. Storage Area
- H. Transom Grab Handle
- I. Above Engine Storage

Length: 22' | Beam: 100 "
Draft: 27 " | Weight: 3600 lbs
Fuel Cap: 48 gal | Seating Cap: 15
Std Engine: AR335
Std Prop: ACME 13.5x16

Chapter 1

BOATING SAFETY



At Axis Wake Research, safety is not an option!

Safe operation of a boat is the responsibility of everyone using the boat. Boats should never be used in an unsafe manner.

If you are not an experienced boater, it is our recommendation that you attend a safe boating class before using your boat.

Drivers should NEVER drive a boat or even be in the driver's seat if alcohol has been consumed and they should NEVER consume alcohol while driving. The driver is responsible for the condition of each guest as well. Drugs, alcohol and boating do not mix.

Drivers must be cognizant of their surroundings, other boats, their wake and other environmental factors including safe turning speeds, people and obstacles in the water, etc.

Driver and boat owner assume all risks for themselves, their guests and anyone in proximity to their boat as it relates to any impairment, unsafe condition, etc.

It is the responsibility of the boat owner and occupants of the boat to understand and comply with all warning labels and safety recommendations/requirements.

General Precautions

Your Axis boat has been constructed to meet all U.S. Coast Guard and National Marine Manufacturers Association (NMMA) requirements. However, it is still your responsibility as the boat owner to ensure the boat is always operated in a safe fashion.

U.S. Coast Guard regulations require certain safety equipment be present on your boat during operation. Besides the U.S. Coast Guard regulations, other local and/or international law enforcement agencies may have similar requirements. You should check with your local marine enforcement agency regarding any such requirements before using the waterways.

It is not intended for this manual to be a replacement for a course on boating safety. It is highly recommended that if you are unfamiliar with the use and operation of a boat, you seek advice and training from a qualified individual or organization. Check with your local boating agency or Axis dealer for more information about boating safety classes in your area.

Safety Statements

Throughout this manual, specific precautions and symbols identify safety related information. Follow these precautions as indicated.



The Safety Alert symbol means Attention! Become Alert! Your Safety Is Involved!

DANGER

Indicates an imminently hazardous situation that, if not avoided, will result in death or serious injury.



Warning

Indicates a potentially hazardous situation that, if not avoided, could result in death or serious injury.



Caution

Indicates a potentially hazardous situation that, if not avoided, could result in minor or moderate injury or property damage. It may also be used to alert against unsafe practices.



Notice: Indicates installation, operation or maintenance information which is important but not hazard related.

The precautions listed in this manual and on the boat are not all-inclusive. If a procedure or method is not specifically recommended, you must satisfy yourself that it is safe for you and your passengers, and that the boat will not be damaged or made unsafe as a result of your decision. **Remember — always use common sense when operating your boat!**

In an emergency situation, you may have to resort to measures which are not commonly practiced. Always assess the dangers of being in harm's way versus the protection of equipment. Keep a sound mind during an emergency and always think safety.

Teak/Drag Surfing

READ, UNDERSTAND and be FAMILIAR with the information contained on any warning labels or any label on equipment and adhere to the boat operation practices described on them. The United States Coast Guard issued a SAFETY ALERT on August 28, 2001 that covers some of the issues of improper use of the boarding platform. The SAFETY ALERT and portions of the accompanying information follow:

Every year tragic deaths occur from the negligence of unsafe boating and dangerous activities. Experts say, “many of these deaths may have been caused by an invisible hazard, carbon monoxide poisoning.” Taking the risk of swimming under a boarding platform when the engine is running, skiing within 20 ft (6.1 meters), “teak surfing” or “dragging” behind a moving boat can be fatal.

Axis DOES NOT consider any dangerous activities which can result in a serious injury or death a watersport. Axis is concerned for all boaters' safety and DOES NOT promote unsafe boating risks, and STRONGLY recommends that boaters refrain from ANY unsafe or dangerous activities. Boaters/users assume all risks for such actions.

DO NOT use the boarding platform for any other purpose than boarding the boat or preparation of entering the water, and DO NOT use the boarding platform when the engine is running.

SAFETY ALERT From August 28, 2001:

The United States Coast Guard advised boaters not to “Teak/Drag Surf.” Recent boating fatalities revealed that carbon monoxide (CO) emitted from a vessel’s exhaust resulted in CO poisoning and the death of at least six teak surfers. “Teak/Drag Surfing” places the individual in position directly exposed to the CO in the engine’s exhaust. This may result in a loss of coherent responses and even death. In addition, “Teak/Drag Surfing” dangerously exposes the individual to a possible propeller injury, and since it is done without a life jacket (PFD), it significantly increases the probability of drowning. Therefore, the Coast Guard stresses, “Teak/Drag Surfing” is a very dangerous activity and advises boaters not to participate in it.

The Coast Guard pointed out that carbon monoxide is one of the most dangerous gases. It strikes before you know you are exposed and it impairs in a way that can and too often does lead to death. That is why it is so important to the Coast Guard that in every circumstance where it can be avoided, it is.

The boat owner, as well as all boat occupants, must ensure that they understand the dangers of carbon monoxide and comply with all safety recommendations/requirements. No one should be allowed to stand or sit in any area of the boat that is not a designated seat while the boat is running.

Regulations

The U.S. Coast Guard is the governing authority of United States waterways and is there to help the boating public. State boating regulations are enforced by local authorities. You are subject to marine traffic laws and “Rules of the Road” for both federal and state waterways; you must stop if signaled to do so by enforcement officers and permit to be boarded, if asked.

Responsibilities

Registration

Federal Law requires that all motorboats be registered and that all motorcraft not documented by the U.S. Coast Guard display registration numbers. In nearly all states, this means registration with the designated state agency. In a few jurisdictions, the Coast Guard retains registration authority. Your Axis dealer will either supply registration forms or tell you where they may be obtained. The agency will supply you with a certificate which must be carried with you when the boat is in operation.

Education

If you have never owned a boat before, you can get an excellent introduction to boat handling from organizations such as the U.S. Coast Guard, American Red Cross or your local authority. Even if you are a veteran boater, these courses will help sharpen your boating skills as well as bring you up to date on current rules and regulations. See your local boating agency or Axis dealer for information on classes in your area.

Insurance

The boat owner is legally responsible for damages or injuries he or she causes. Common sense dictates that you carry adequate personal liability and property damage insurance on your boat, just as you would on your automobile. You should also protect your investment from physical damage or theft.

Restricted Areas

Before boating, check with Local, State and Federal authorities to identify restricted areas. Because of the threat of terrorism, the U.S. Coast Guard has and will continue to implement strict limits on watercraft near U.S. Navy and Coast Guard ships and other potential targets.

Our Environment

As a boater, you already appreciate nature's beauty and the peace of the great outdoors. It is a boater's responsibility to protect the natural environment by keeping waterways clean. **DO NOT put anything in the water you would not want to eat or drink!**

Conserve Fishery Resources

There is a tremendous drain on our fishery resources. Over-fishing and pollution have strained the fish population. Do your part by keeping only what you will eat by practicing catch-and-release.

Foreign Species

If you trailer your boat from lake to lake, you may unknowingly introduce a foreign aquatic species from one lake to the next. Thoroughly clean the bottom of the boat, below the water line, remove all weeds and algae, and drain the bilge and livewells before launching the boat in a new body of water.

Fuel and Oil Spillage

The spilling of fuel or oil into our waterways contaminates the environment and is dangerous to wildlife. Never discharge or dispose fuel or oil into the water; it is prohibited and you could be fined. There are two common, accidental types of discharge:

- Overfilling the fuel tank.
- Pumping contaminated bilge water.

Warning



Fumes from rags can collect in bilge and be extremely hazardous. Never store rags used to wipe up fuel or solvent spills in the boat. Dispose of rags properly ashore.

Discharge and Disposal of Waste

Waste means all forms of garbage, plastics, recyclables, food, wood, detergents, sewerage and even fish parts in certain waters - in short, nearly everything. We recommend you bring back everything you take out with you for proper disposal ashore.

Excessive Noise

Noise means engine noise, radio noise or even yelling. Many bodies of water have adopted noise limits. Music and loud conversation can carry a considerable distance on water, especially at night.

Wake and Wash

Be alert for NO WAKE zones. You are responsible for any damage or injury caused by your wake/wash. Prior to entering a NO WAKE zone, come off plane to the slowest steerable speed.

Exhaust Emissions

Increased exhaust (hydrocarbon) emissions pollute our water and air. Keep your engine tuned and boat hull clean for peak performance. Consult your dealer and engine manual for information.

Paints

If your boat is kept in water where marine growth is a problem, the use of anti-fouling paint may reduce the growth rate. Be aware of environmental regulations that may govern your paint choice. Contact your local boating authorities for information.

Cleaning Agents

Household cleaners should be used sparingly and not discharged into waterways. Never mix cleaners and be sure to use plenty of ventilation in enclosed areas. DO NOT use products which contain phosphates, chlorine, solvents, non-biodegradable or petroleum based products. Refer to CARE AND MAINTENANCE for more information.

Safety Equipment

U.S. Coast Guard regulations require certain accessory equipment on each boat. For a detailed description, obtain “Federal Requirements for Recreational Boats” published by the Coast Guard.

- 1) Personal Flotation Devices (PFDs): PFDs must be Coast Guard approved, in good and serviceable condition and the appropriate size for the user. It is recommended that you wear PFDs while your boat is underway.

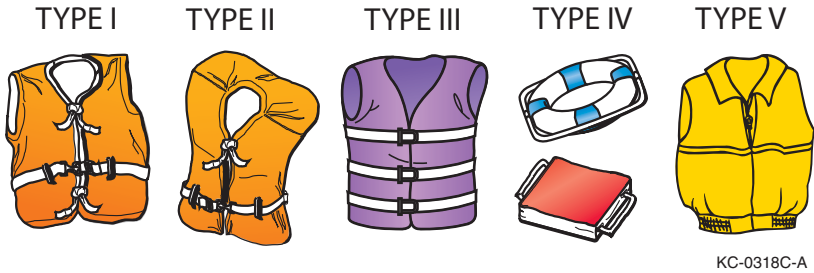

Figure 1-1. Personal Flotation Devices

Boats more than 16 feet in length must be equipped with one type I, II, III or V and one type IV. PFDs are intended to save lives; you and your passengers should wear them while in the boat. Learn how to use them and adjust as necessary to make comfortable to wear. The type II PFD is recommended for near shore or inland water use. Some PFDs are specially made for use while waterskiing and can handle impacts if a skier has fallen.

Notice: If a type V PFD is to be counted toward the minimum carriage requirements, it must be worn.

- 2) Fire Extinguishers: A fire extinguisher is required if your boat has an inboard engine, or when fuel is stored in closed stowage compartments.

Approved fire extinguishers are classified by a letter symbol, either B-I or B-II with the B designating that the material will extinguish flammable liquids such as gasoline, oil, etc. B-I extinguishers are required for boats less than 26 feet in length. Check periodically to ensure that the extinguisher is in working condition and fully charged.

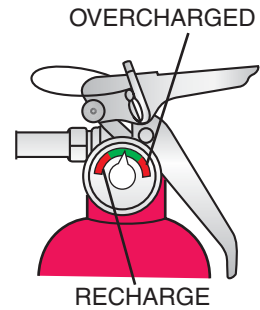

KC-0009C-A

Figure 1-2. Fire Extinguisher

- 3) Navigation Lights: Recreational boats are required to display navigational lights between sunset and sunrise and other periods of reduced visibility (fog, rain, haze, etc.). Your navigation lights are provided to keep other boats informed of your presence and course. It is up to you to make sure they are operational and turned on when required.

Emergencies

Giving Assistance

Many of the distress calls are not true emergencies. In most cases, the boat is disabled for one reason or another, but there is no immediate danger of death or serious injury. However, emergencies can occur and you should know how to cope with them. If you observe a boat in distress, assume it is a true emergency. Proceed to the scene and render assistance. Federal law requires boat operators to offer assistance and aid to others. The law's "Good Samaritan" clause absolves you from any civil liability in the event that your assistance causes injury or property damage.

There is a way to handle nearly every emergency if you do not panic. Learn your boating lessons and safety procedures well, and you will have the confidence and ability to handle an emergency should one arise.

Fires

Many boat fires involve flammable liquids such as gas or oil. Many inboard fires start in the bilge area which at times can be filled with gas vapors. Since gas vapors cannot be seen, boat fires tend to travel very fast. If you encounter a fire on board, turn off the engine immediately. If you have a fire extinguisher on board and access to the fire, it may be controllable. Direct the contents of the extinguisher at the base of the flames. Throw burning materials overboard if possible. Put on PFDs, if not already on, signal for help and prepare to abandon the boat if necessary.

Reporting Accidents

Boat operators are required by law to file a Boating Accident report with their state boating law enforcement agency or local authority when their boat is involved in certain boating accidents. A boating accident must be reported if there is a loss or probable loss of life, personal injury requiring medical attention, damage exceeding \$500, or there is a complete loss of the boat. If any of these conditions arise, seek further assistance from local law enforcement personnel.

Hazardous Conditions

Every waterway poses hazards that should be avoided. The following information outlines some of the hazards which may be encountered.

Weather

Learn and understand weather patterns and signs of change. Bad weather can cause an uncomfortable and unsafe situation. If a storm approaches, seek a safe harbor.

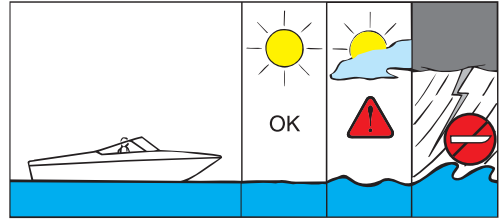

KC-0210M

Figure 1-3. Weather Hazards

Dam Spillways

The area around dam spillways is very hazardous and conditions can change rapidly. Stay clear of the spillways and areas below dams.

Weeds

Weeds can generally be a threat to a boat's engine and other components on the boat. If weeds wrap around the propeller, they can create vibration in the engine. They also restrict water intake, causing the engine to overheat.

Shallow Water Operation

Shallow water brings on obvious hazards such as sand bars, stumps, rocks, etc. Know the area you will be operating the boat in. Hitting objects at high speeds can cause severe damage to people and the boat. If you know you will be navigating the boat in shallow water, post a lookout and proceed slowly.

Know the minimal depth your boat can safely travel.

Warning



Damage to underwater gear caused by shallow water maneuvering is not covered by your warranty.

Warning Markers

Learn to recognize the different buoys and day markers; they are used as the signposts of the waterways identifying navigable routes and water hazards. It is a good idea to ask local authorities about hazard areas and if they are marked. Stay within boundaries and clear of hazards.

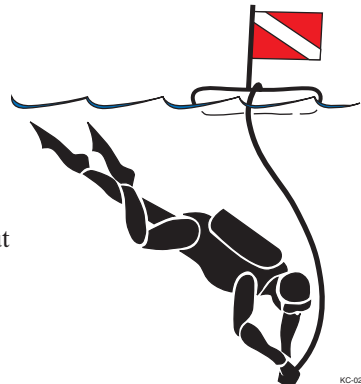

KC-0250M

Figure 1-4. Diver Down Flag

Carbon Monoxide

Carbon Monoxide (CO) is a colorless and odorless gas produced by all engines and fuel burning appliances. Even with the best boat design and construction, plus the utmost care in inspection, operation and maintenance, hazardous levels of CO may still be present in accommodation spaces under certain conditions. To reduce CO accumulation, always ventilate the boat interior and avoid boating situations which cause increased exposure.

The boat owner, as well as all boat occupants, must ensure that they understand the dangers of carbon monoxide and comply with all safety recommendations/requirements. No one should be allowed to stand or sit in any area of the boat that is not a designated seat while the boat is running.

It is the responsibility of the boat owner and occupants of the boat to understand and comply with all warning labels and safety recommendations/requirements.

DANGER



EXTREME HAZARD – Carbon monoxide gas (CO) is colorless, odorless and extremely dangerous. All engines and fuel burning appliances produce CO as exhaust. Direct and prolonged exposure to CO will cause BRAIN DAMAGE or DEATH. Signs of exposure to CO include nausea, dizziness and drowsiness. Sources of CO include:

- 1 Blockage of boat exhausts by obstruction.

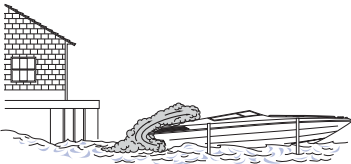

- 2 Exhausts traveling along obstruction.

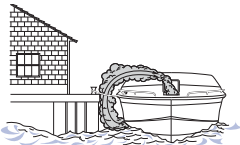

- 3 Operating at slow speed or while dead in the water.

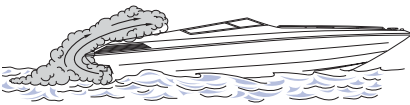

- 4 Operating with high bow angle.

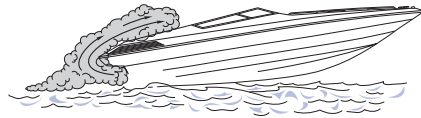

- 5 Exhausts from other vessels in confined areas.



- 6 Operating with canvas tops and side curtains in place without ventilation.



ENSURE ADEQUATE VENTILATION FOR CORRECT AIR MOVEMENT THROUGH BOAT!

KC-0461M

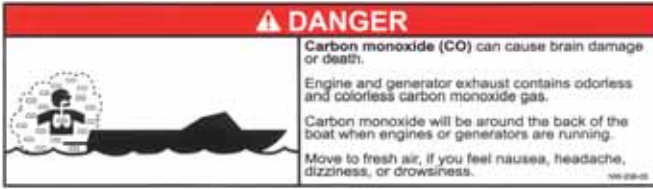

Figure 1-5. Carbon Monoxide Hazards

Operation by Minors

If your boat will be operated by a minor, remember to have an adult present at all times. Many states have laws regarding minimum age and licensing requirements for minors. Contact state and local authorities for special requirements that may apply in your area.

Passenger Safety

Any time you take your boat out, make sure that there is at least one other passenger aboard who is familiar with the operation of your boat. Passengers should be well aware of emergency equipment and shown how to use it. Passengers should also keep hands and feet in the boat and be safely seated while the boat is in motion.

Your boat should never be operated while you are under the influence of alcohol or drugs. Reaction times can be reduced and judgment affected creating situations that can be very dangerous.

Warning



Federal and state laws prohibit operating a boat under the influence of alcohol and other drugs. These regulations are actively enforced. Impaired operation may result in severe personal injury or death.

Basic Rules of the Road

Warning



The nautical rules of the road must be followed to prevent collisions between vessels. Like traffic laws for automobiles, the operator is legally required to follow the rules.

The following information outlines only the most basic of the nautical rules of the road. For more information, contact your local U.S. Coast Guard Auxiliary or local maritime authority.

Aids to Navigation

Learn to recognize the different buoys and day markers; they are the signposts of the waterways. The United States Aids to Navigation System (USATONS) is the primary marking system used on inland water, coastal waters and rivers in the United States. This system is maintained by the U.S. Coast Guard (USCG).

Types of Buoys

There are several types and shapes of buoys. Buoys may be unlighted, lighted, with sound or may have both an audible and a visual signal. Lights, bells and horns are used on buoys for night or poor visibility conditions. Different shapes of buoys are shown below.

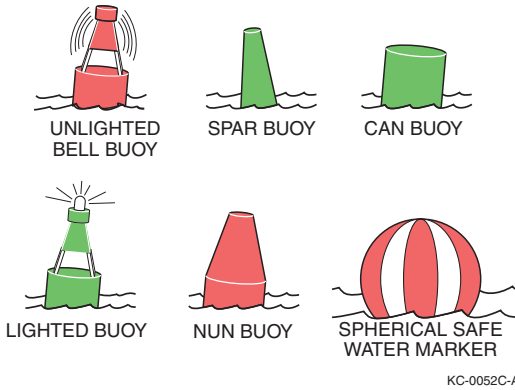

Figure 1-6. Types of Buoys

Buoys with unique light flashing characteristics are identified on nautical charts with the specific flashing pattern.

Mooring Buoys

The only buoys you are permitted to moor to are mooring buoys. Mooring buoys are white with a blue horizontal stripe. Mooring to a navigation buoy, regulatory markers or lateral markers is illegal.

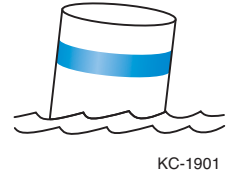

Figure 1-7. Mooring Buoys

Regulatory Markers

Regulatory markers indicate dangerous or restricted controlled areas. These markers are used to indicate speed zones, areas set aside for particular use, general information and directions.

Regulatory markers are white with orange geometric shapes and also have orange bands near the top and at the water line of the buoy. You must obey regulatory markers.

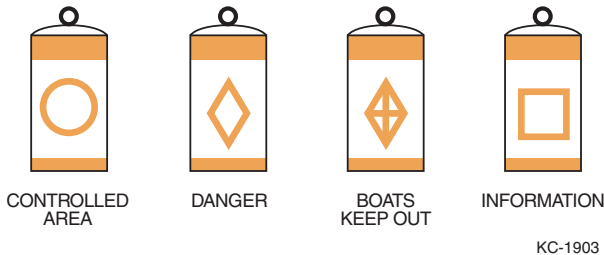

Figure 1-8. Regulatory Markers

Right-of-Way

Notice: In general, boats with less maneuverability have right-of-way over more agile craft. You must stay clear of the vessel with right-of-way and pass to his stern.

Privileged Boats

Privileged boats have right-of-way and can hold course and speed. Sailboats and boats paddled or rowed have the right-of-way over motor boats. Sailboats under power are considered motorboats. Small pleasure craft must yield to large commercial boats in narrow channels.

Burdened Boats

The burdened boat is the boat that must make whatever adjustments to course and speed necessary to keep out of the way of the privileged boat.

Crossing Situation

In crossing situations, the boat to the right from the 12 o'clock to the 4 o'clock position has the right-of-way. It must hold course and speed. The burdened boat keeps passes behind the privileged boat. Boats going up and down a river have the privilege over boats crossing the river.

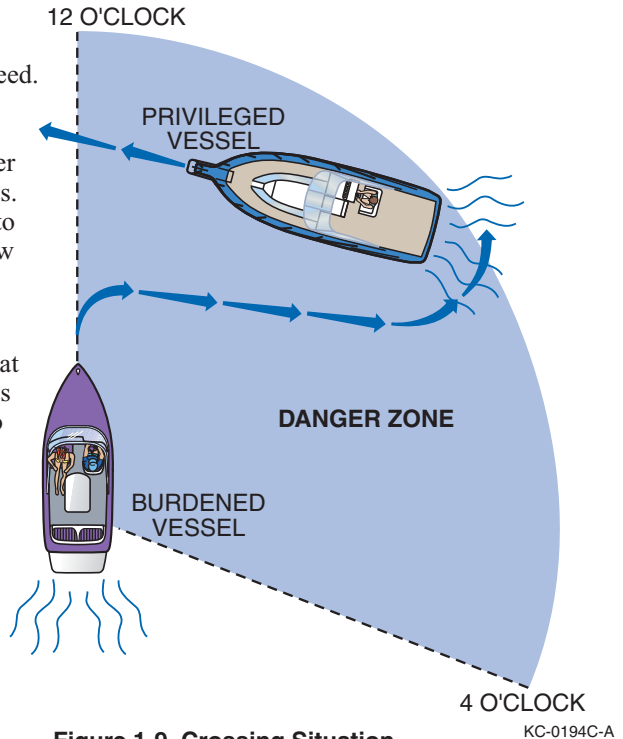

Figure 1-9. Crossing Situation

Meeting Head-On

Neither boat has the right-of-way in this situation. Both boats should decrease speed, should turn to the right and pass port-to-port. However, if both boats are on the left side of a channel, each vessel should sound two short horn blasts and pass starboard to starboard.

Overtaking

The boat that is overtaking one ahead of it is the burdened boat and must make any adjustments necessary to keep out of the way of the privileged boat.

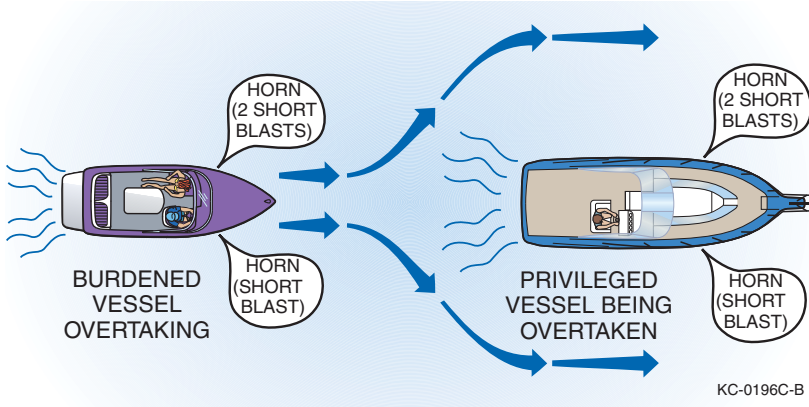

Figure 1-10. Overtaking Another Craft

The General Prudential Rule

The general prudential rule regarding right-of-way is that if a collision appears unavoidable, neither boat has right-of-way. As prescribed in the Rules of the Road, both boats must act to avoid collision.

Night Running

Boats operating between sunset and sunrise (hours vary by state) must use navigational lights. Nighttime operation, especially during bad weather or fog can be dangerous. All Rules of Road apply at night, but it is best to slow down and stay clear of all boats, regardless of who has right-of-way. Protect your night vision by avoiding bright lights and have a passenger, if possible, help keep watch for other boats, water hazards and aids to navigation.

Chapter 2

GAUGES & CONTROLS



No other ski boat manufacturer incorporates in their product as many innovative and technically advanced features as Axis Wake Research.

Standard Gauges

The following gauges are included on all models. It is important for the safe and proper operation of your boat to fully understand these gauges.

Axis In-Dash Graphical Display



Figure 2-1. Graphical Display

Tachometer

The Axis tachometer has an alphanumeric display that allows the user to access both boat and engine information. This is accomplished by using the “INFO ADJUSTMENT” button located on the dash.

Some information, such as the depth, may not be present depending on if a depth module has been installed.

There are some information and alarms that can be adjusted using the “INFO ADJUSTMENT” button. To enter the edit mode, hold the down arrow for 3 seconds. The display will blink while in edit mode. No button presses for 3 seconds will automatically return the display to normal operation.



Figure 2-2. Tachometer

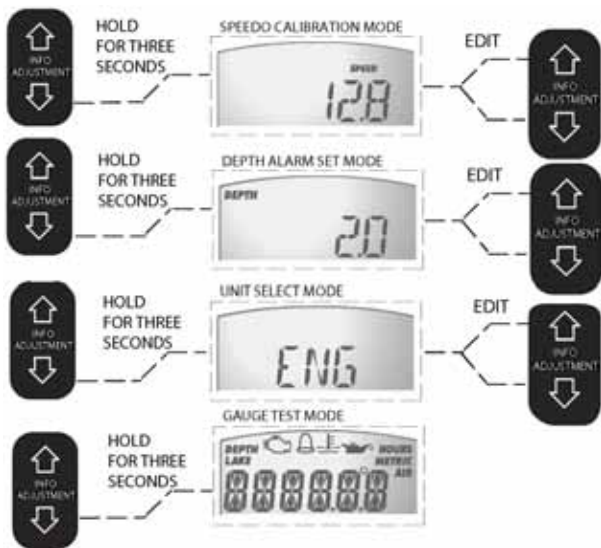

For boats equipped with optional depth finders, the depth system may lose its lock on the bottom if speeds exceed 20 mph. This is normal. The depth system should reacquire the bottom once the boat has slowed to under 20 mph.



Speedometer Cruise

The Axis speedometer has an LCD that shows the fuel level and cruise control status. The speedometer can control either the speed of the boat or the RPM of the engine.

If ACTUAL is blinking while the cruise control is engaged, more throttle is required in order to maintain the set speed.



Figure 2-3. Speedometer

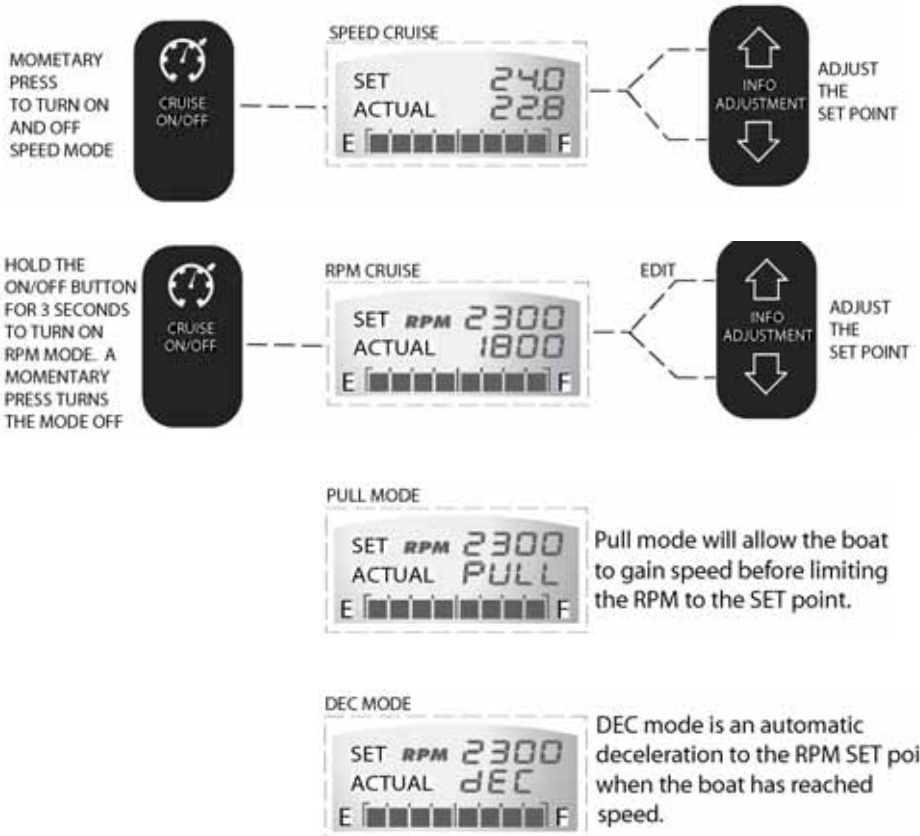

Circuit Breakers

All major boat circuits are protected from shorting and overload by resettable circuit breakers. If a problem develops with one of the following circuits, switch off the circuit and wait about one minute. Then push the appropriate breaker button fully and switch on the circuit. If the circuit continues to trip, there is a problem somewhere in the system. See your dealership immediately to locate the problem.



Figure 2-4. Circuit Breaker Panels

Switches & Indicators

Accessory Switch Panels

These panels are located in the dash directly below the standard gauges and are used to activate the following features. You will find the feature or accessory provided within each button face for description.

- Horn
- Navigation/Anchor Lights
- Interior/Dash Lights
- Blower
- Bilge Pump
- Docking Lights
- Center Ballast
- Left, Rear Ballast
- Right, Rear Ballast
- Accessory
- Accessory
- Info Adjustment
- Speed/RPM Adjustment
- Cruise ON/OFF



IGNITION SWITCH

Figure 2-5. Accessory Switch Panel

Navigation/Anchor Lights

In the ANC (anchor) position, this switch is used to activate the all-around light on the tower. Keep the all-around light on after dusk whenever your boat is at rest in the open waterway. While underway, place the switch in the NAV position to also activate the red and green navigation bow lights.

Interior/Dash Lights

This switch is used to activate the interior lights. The interior lights include lights in the gunnels, storage compartments, dashboard and optional underwater transom lights, if equipped.

Blower

This switch activates the blower for the engine compartment. The primary function of the blower is to eliminate any fumes in the motor compartment when starting the engine or during idling.

Warning



Gasoline Vapors Can Explode. Before starting engine, operate blower for 4 minutes and check engine compartment for gasoline leaks or vapors. Run Blower below cruising speed.

Bilge Pump

The bilge pump switch is used to activate the bilge pump so that any excess water in the bilge area may be drained out. You should know that the bilge pump has a sensor in the bilge area and will turn on automatically whenever 2 in. or more of water is detected.

The bilge pump is wired directly to the battery. This circuit can be identified by an inline fuse from the battery labeled “Auto Bilge Power.” If your boat takes on water for any reason, the auto bilge pump will activate and continue to run until the water level drops low enough to deactivate the pump. If water continues to enter the boat, the pump will continue to run until the battery is drained.

Docking Lights

This switch is used to activate the docking lights. Only use docking lights during slow speed docking maneuvers.

Ballast Switches

These switches are used to fill or drain the corresponding ballast tank. Press the top of the switch to fill the tank. Press the bottom of the switch to drain the tank.

Accessory #1

This switch is used to supply power to the optional heater unit. (For information on the use of the heater, please see *Heater* in the optional equipment section of this manual.)

Accessory #2

This switch is used to supply power to aftermarket accessories. Attaching an accessory to this switch should only be done by a qualified technician.



Figure 2-6. Inline Fuse

Stereo Power

The optional stereo system can be activated by either turning the ignition key on, or can be used without the engine started by turning the key to the left position; the stereo head unit is located on the helm to the left of the steering wheel.

Throttle Control

The throttle lever is located to the right of the driver. When the throttle is vertical, it is in the “NEUTRAL” position. At the base of the throttle you will find the shift lock knob. Pulling outward on this knob disengages the transmission, thereby allowing use of the throttle without engaging the transmission. This is used for warm-up of the engine in neutral. Be sure to position the throttle vertically (in “NEUTRAL”), before re-engaging the transmission, by depressing the knob.



Figure 2-7. Throttle

When engaging the transmission from “NEUTRAL” to either forward or reverse, you must pull up on the safety collar located directly below the throttle lever knob.

Warning



Do not shift from forward to reverse at high RPMs; damage to the transmission will result. When shifting from forward to reverse you must stop in the NEUTRAL position, doing this allows the engine to run in its idle position before moving into the opposite gear. Moving the shift lever from FORWARD to REVERSE without stopping in NEUTRAL can cause the transmission to “slam” into gear, damaging the transmission and/or causing the engine to shut off. This will cause temporary loss of boat control which can cause damage and/or injury to the boat and/or persons in or around the boat.

Warning



Before starting the engine or engaging transmission, ensure all swimmers are out of the water.

Steering System

It is important that you get the “feel” of your Axis boat’s steering system. Turn the wheel from full left to full right, and make sure the rudder is turning accordingly. The system should operate freely and smoothly. See *Axis Exclusive Adjustable Rudder System* in Chapter 3 for rudder adjustment.

Notice: It is normal for your Axis steering to pull slightly to the right under normal driving conditions.

Emergency Engine Stop Switch

The emergency stop switch attaches to the operator of the boat and shuts down the engine if the operator is accidentally forced away from the helm.

The switch consists of an ON/OFF switch and a switch clip/lanyard clip, which is connected between the stop clip and the operator. Should the operator move away from the controls, the clip pulls free, flipping the switch to the OFF position and stopping the engine. If the engine must be shut down quickly, a pull on the lanyard cord to release the clip from the switch will stop the engine.

To reset the switch after activation, reinstall the lanyard clip and flip switch to the UP position.



Figure 2-8. Emergency Engine Stop Switch

Motorbox Cover

The fiberglass motorbox reduces engine noise and provides protection for the passengers on board. To open, grasp the pull strap and lift open. The motor box is equipped with a gas-filled shock absorber to provide support for the compartment when opened.

Warning



Running the engine with the motor box open exposes rotating machinery which can cause injury to occupants of the boat.



Figure 2-9. Motorbox

Driver's Seat

The driver's seat can be adjusted forward and backward by pulling the lever located on front left side of the driver's seat. Pull lever outward and adjust seat as needed.

Swivel Seat Base

All models are equipped with a swivel seat adjustment. To adjust the seat, pull up on the lever located on the port side of the seat. The seat should swivel freely. To reset the seat position, rotate the seat back to its original bow-facing position.



Figure 2-10. Bolster Seat



Figure 2-11. Seat Adjuster

Sundeck

Most boat models are equipped with a standard sundeck feature designed for sunbathing comfort.

Warning



The Sundeck is not to be used while the engine is running. Serious injuries or death could occur to persons not seated properly should the boat come to an abrupt halt.



Figure 2-12. Sundeck

V-Drive Engine Access Hatch

An engine access hatch is located behind the rear observers' seat on the V-Drive. Access allows the ability to service engine for required maintenance and for additional storage on both sides of the engine.



Figure 2-13. Engine Access Hatch

Ski Pylon

The pivoting-head ski pylon is an aluminum post located directly in front of the motor box.

Warning



The optional ski pylon is designed for normal water skiing activities: slalom, jumping, kneeboarding, tricks and barefooting. Any other uses such as parasailing, kite flying, towing pyramids of skiers, etc., may over-stress the pylon and possibly cause personal injury and/or equipment damage. DO NOT overload the pylon or use it for anything other than watersports.



Figure 2-14. Pivoting-head Ski Pylon

Swim Platform

A removable swim step is located on the stern of the boat to provide easy access into and out of the water for boat skiers and swimmers. To remove, disconnect the pins located on each side the platform brackets, and, depending on model, either lift or slide back on platform. To replace, reverse these steps. Be sure the pins are securely attached.

Warning



DO NOT use the boarding platform for any other purpose than boarding the boat or preparation of entering the water, and DO NOT use the boarding platform when the engine is running.



Figure 2-15. Swim Platform

Warning



A spinning propeller or carbon monoxide can cause serious injury or death. Stay off and keep away from boarding platform while engine is running. The boarding platform must be attached when the boat is in use.



Figure 2-16. Swim Platform Pins

Navigational Lights

As required by the U.S. Coast Guard and most maritime authorities, all recreational vessels are required to display navigational lights between sunset and sunrise and other periods of reduced visibility. All Axis Boats are equipped with bow and all-around navigational lights.

The bow light located at the tip of the bow is two colored — red and green, and is used to keep others aware of your presence when operating your boat at night.

The all-around light is attached to the tower on all Axis boats.



Figure 2-17. Bow Light

Caution



The bow light will get hot upon illumination, which can cause burns if touched. The light can stay hot for an extended period of time after it has been turned off.

Storage Areas

Observer Storage Area

The storage area behind the observer seat is accessible by opening the observer seat door from left to right.

Under Seat Storage

Conveniently located on both sides of the boat, these storage areas are ideal for all of your gear.

Transom Storage

The storage is accessible from either the interior or from the transom swim platform by lifting the hatch cover.



Figure 2-18. Transom Storage

Bow Storage

The seat cushions can be removed to provide additional storage.



Figure 2-19. Bow Storage

Glove Box Storage

Located on the port side of the boat above the observers' seat for easy access and storage. This small area can be used to store registrations, tools, wallets, cell phones, etc.

Warning



The glove box is not water-tight. To prevent water damage to paperwork and/or electronics, we suggest placing electronics such as cell phones and iPods in a ziplock bag to prevent damage from rain or water over the bow.



Figure 2-20. Glove Box Storage

Drain Plugs

Your Axis is equipped with two drain plugs; one located at the transom of your boat and one T-handle located mid-ship near the driver's seat, reachable through the access plate in the floor.

Transom Drain Plug

This plug is located in the center of the transom at the bottom edge, and is provided to allow for drainage of the bilge area, when needed.



Figure 2-21. Transom Drain Plug

Warning



Ensure all drain plugs are secure prior to launching your boat. Damage caused as a result of these plugs not being installed will not be covered under your Axis warranty.

Bilge Drain Plug

A T-handled, brass bilge drain plug is located in the bilge. Location is mid-ship near the driver's seat, reachable through the access plate in the floor. The T-handle can be found by removing the rear center seat and fiberglass compartment cover under the seat. The T-handle is located just below the V-drive unit.



Figure 2-22. Bilge Drain Plug

Warning



Ensure that all transom and bilge drain plugs are securely in place before placing the boat in the water.

Speedometer Pickup

Your boat is equipped with a Paddle wheel speedometer pickup, which can be found directly under the running surface of your boat. The paddle wheel is used to measure static water by rotation of the paddle wheel unit. This information is transferred to the dash computer and a computer program converts information which is transferred to the speedometer gauge.



Figure 2-23. Thru-Hull Paddle Wheel Pickup

See *Troubleshooting* section of this manual for basic maintenance information.

Tilt Steering Wheel

The tilt steering wheel allows for maximum driver comfort. To adjust the height of the wheel, simply press down on the lever located under the wheel. Move the wheel to the position that is most comfortable. When the wheel is in the desired position, simply release the lever to lock the wheel in place.

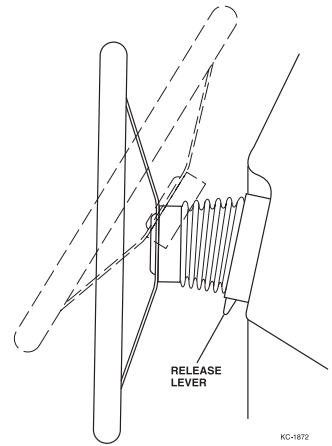

Figure 2-24. Tilt Steering

Exhaust

The exhaust system is used to remove engine exhaust fumes. To ensure that your boat's exhaust system is working correctly, it is important that you inspect for exhaust leaks. The following information will allow you to check these systems. Keep in mind that you will be checking engine while turned on, and that you will need to take safeguards against getting yourself or others caught in the moving parts. Use extreme caution while performing this task.

- Turn engine off and disconnect the engine safety switch. Be sure the throttle shift control is neutral. The engine must be cool.
- Open the engine and visually check the exhaust system from the engine to the transom for obvious damage.
- Reinstall engine safety switch and start the engine with engine compartment open. Check hose connections between the exhaust manifolds and the muffler for leakage.
- If leakage is apparent, tighten the hose clamps, being careful not to crimp the hose. See your Axis dealer for parts and or service.

Notice: The AR335 CAT engine equipped with the ETX Catalyst Exhaust Manifolds may produce an unusual smell which is characteristic of an engine with a catalyst exhaust system.

Ventilation

The ventilation is used to remove potentially hazardous accumulation of explosive vapors from the bilge areas of your boat's hull and engine compartment. Therefore, proper ventilation is essential to the safety of the boat and persons in or around the boat structure.

Your boat is equipped with a ventilation system that will ensure complete removal of these dangerous fumes. However, it is your responsibility as the operator of the boat to ensure these systems are working efficiently. The boat's primary source for expelling fumes from the boat is the blowers located in the bottom of the bilge and at the transom venting points.

Your boat is also equipped with a natural air-intake that forces air through a venting system on the deck of your boat, and channels air from the bilge to the transom vent.

Cooling

Most boats will be cooled with a continuous intake of lake water circulating it around engine components.

Closed Cooling System

If your boat is equipped with an optional closed cooling system, you will need to maintain correct fluid levels.

- Open engine compartment and remove reservoir cap.
- Ensure coolant is to the top of the reservoir filler neck.
- Use Sierra Anti-Freeze.

Notice: To ensure we are always mindful of our environment; it is an Indmar and Axis Boat recommendation to use Sierra Brand antifreeze because of its propylene glycol formulation. SIERRA Antifreeze is less toxic and safer than ethylene glycol coolants to children, pets and wildlife, in case of spills, leaks, boil-over or careless disposal.

Caution



The engine must be cool when checking the coolant level. Hot coolant and steam under pressure may cause injury.

Optional Equipment

Heater

If your boat is equipped with a heater, you will find a HIGH/LOW accessory switch located on the dash panel. Located at the base of the observer seat walkway is a snorkel tube that can be pulled out and directed wherever you like within a five-foot radius. Please refer to the information provided in your owner's packet for specific use.



Figure 2-25. Heater

Boat Cover

If your boat is equipped with this option, know the type of cover you are placing on your boat. Some Boat Covers have been made strictly for mooring and storage only, and some have been made for storage and travel. If you question the type of cover that you have purchased, check with your Axis dealer for assistance. Do not cover the boat if the interior is wet or damp. This can promote mildew growth.



Figure 2-26. Boat Cover

Warning



Damage caused to your boat as a result of improper cover use is not covered under your Axis Boats warranty. Damage can result from wind whipping, and possibly cause abrasions to your gelcoat surface or upholstery. Use the proper shipping cover for travel purposes.

Pull-Up Cleats

Pull-Up cleats are available for all boat models. These cleats will sit flush on the side of the boat deck when depressed. To use the cleats, simply pull them up. Push the cleats down to stow them.



Figure 2-27. Pull-Up Cleat

Docking Lights

The docking lights should only be used during slow speed docking maneuvers. The lights are activated by a switch on the accessory switch panel and have a 10 amp circuit breaker. The docking lights use LED bulbs and cannot be replaced.

Tower

FatAX Tower (Standard)

This tower's main hoop is made of oversized 3" tubing and the bases are billet aluminum and through-bolted with backing plates.

Properly stow the bimini top in its boot and remove all boards from the board racks prior to towing/trailing your boat. Damage to the bimini from towing while not stowed is not covered under warranty. Damaged or excessive wear to board racks caused by towing or trailering with boards attached is not covered under warranty.



Figure 2-28. FatAX

Warning



Due to vibration and rough water conditions it is possible for bolts to loosen. Before each use, inspect all mounting bolts (Tower, Wakeboard Racks, Lights, Speakers, etc.) to ensure they are tight. See your local dealer for any questions and/or assistance. Failure to do so can cause serious damage and/or injury to the boat and/or passengers.

The tower is rated for a maximum of 130 lbs (58.9 kg) accessory weight and not more than 600 lbs (272.1 kg) total rider weight. Exceeding these limits voids any structural warranty pertaining to the tower. Approved activities for usage of the tower include wakeboarding, wake skating, skiing or tubing.

Only factory pre-drilled holes should be used to install factory accessories on the tower. The use of aftermarket accessories not supplied by Axis Wake Research may cause damage not covered by the tower warranty. Drilling any additional holes in the tower will void any structural warranty.

Hardware

Most of the metal hardware on your boat consists of brass, stainless steel, or aluminum and should be cleaned on a periodic basis with soap and water. In fresh water, metal fittings and hardware should be sprayed regularly with a rust inhibitor, and after every use in saltwater.

DO NOT use cleaners that are not intended for use on stainless steel. Glass, tile, counter or citrus cleaners can damage hardware permanently. Always follow cleaning, by applying a high-quality metal polish or automotive wax after cleaning. Test products in an inconspicuous area before applying to the complete surface, especially if you are not familiar with the product.

All metal parts, including but not limited to tower accessories, board racks or speaker cans, should be cleaned with mild soap and water frequently and waxed periodically. A corrosion protectant is highly recommended on these components for use in areas of salt/brackish water. Pitting or oxidation is not covered under warranty. Pitting is not the same as separation.

Wedge

The Axis Auto-Set Wedge foil is a solid, one piece, welded design constructed from solid stainless steel. The wedge foil does not lock in the down position. It is designed to move up or down freely and locate in the down position.



Figure 2-29. Wedge Down

To lower wedge unit, depress spring loaded pins and lower foil. Be sure to raise and lock foil in the up position each time after use.

If your boat is equipped with the Wedge option, you will find that the unit has two positions - DOWN or UP. To adjust wedge position, access wedge through the swim platform door.



Figure 2-30. Wedge Up

Caution



Ensure both spring loaded pins are engaged before taking off.

Warning



Excessive speeds over 25 MPH could cause adverse handling conditions. It is recommended that you put the Wedge unit in the UP position if you will be traveling over these speeds.

Chapter 3

OPERATION



Everyone benefits from the safety of others.

Trailer

The trailering information contained in this section describes general guidelines and procedures used by many boaters. We recommend, in addition, that you always follow the specific information provided by the manufacturer of your trailer.

Load Carrying Capacity

The certification label attached by the manufacturer on the left forward side of the trailer will show the maximum load carrying capacity of the trailer. The label is required to show the Gross Vehicle Weight Rating (GVWR), which is the load carrying capacity plus the weight of the trailer itself. Be sure that the total weight of your boat, gear and trailer does not exceed the GVWR. Verify tire pressure for load capacity.

Notice: Consult your trailer dealer for other state regulations concerning brakes, lighting and other equipment options.

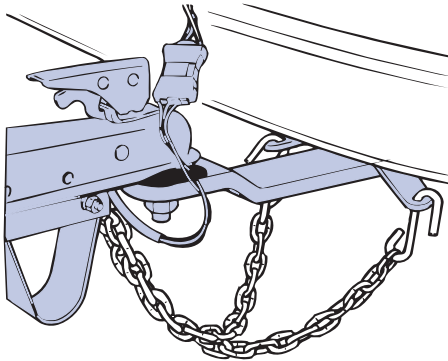

Figure 3-1. Trailer Hitch

KC-1700

Most boat trailers connect to a ball hitch that is bolted or welded to the towing vehicle. Clamp-on bumper hitches are not recommended.

The trailer hitch coupler must match the size of the hitch ball. Never use a hitch ball that does not match the trailer coupler. The correct ball diameter is marked on the trailer coupler.

Hitch

Hitches are divided into classes that specify the gross trailer weight (GTW) and maximum tongue weight for each class. Always use a hitch with the same class number as the trailer, or greater.

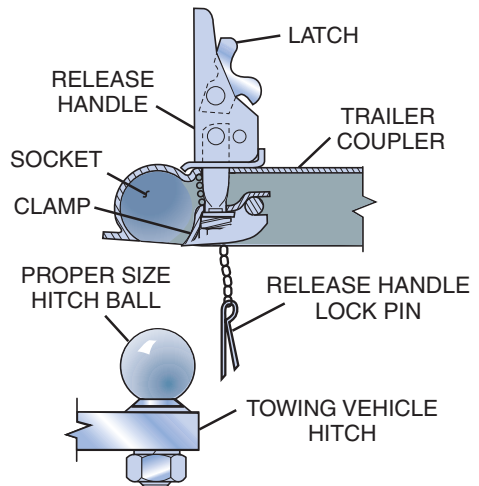

KC-0043C-A

Safety Chains

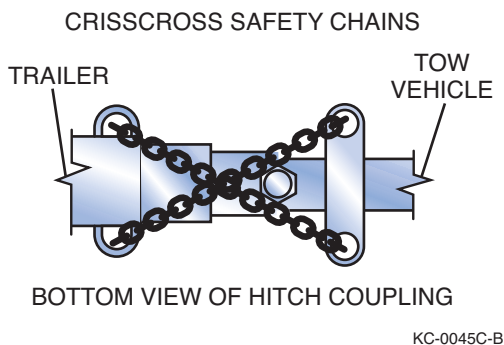

Safety chains on your boat trailer provide added insurance that it will not become completely detached from the towing vehicle when underway.

Crisscross the chains under the trailer tongue to prevent the tongue from dropping to the road if the trailer separates from the hitch ball. Rig the chains as tight as possible with just enough slack to permit tight turns.

Make sure the proper chains are correctly attached between the towing vehicle and trailer before and during each trip.

Figure 3-2. Safety Chains

Tie-Downs

Making sure your boat is held securely in place on the trailer hull supports is extremely important, especially when underway. Regardless of your trailer make or model, there are two key areas to consider:

- **Bow Tie-Downs:** A bow stop to hold the front of your boat in place is located on the winch stand. It should be positioned so that the winch line pulls straight and is parallel to the trailer frame. A separate tie-down should then be attached to hold the boat downward and forward. This may be accomplished by a line from the bow eye to an attachment point on the trailer frame or winch stand.

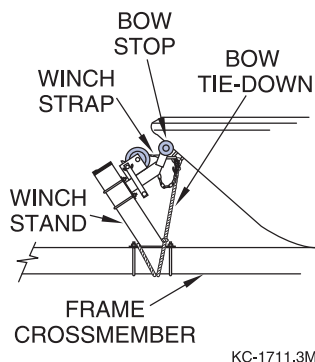

Figure 3-3. Bow Tie-Down

- **Rear Tie-Downs:** It is very important to be sure the transom of your boat is resting fully and securely on the supports provided at the rear of the trailer, and that it remains in place when parked or underway. Special rear tie-downs are available for this purpose. Check often to be sure the rear tie-downs are securely locked in place and tight enough to prevent any movement of the boat.



Figure 3-4. Transom Tie-Down

Backing the Trailer

Backing the boat trailer may sometimes be a difficult task. It is recommended that you practice backing the trailer in a vacant lot or open area before attempting it at a congested boat launch.

Follow these basic rules when backing:

- 1) Turn the front vehicle wheels in the opposite direction in which the trailer is to travel.
- 2) Back vehicle normally once the trailer turn is started.
- 3) Have your vehicle equipped with a right hand mirror, as required by law when towing.

Launching

Following are some helpful tips to assist you with launching your boat:

- Before launching, check the type and condition of the ramp. Ramps are usually made of cement but often times are made of asphalt or even sand. When wet, these ramps can get very slick and can cause additional difficulties when launching your boat.
- Have someone assist you when backing your boat. Back the trailer to the edge of the water and stop. Be sure to properly secure your vehicle.
- Prepare for placing the boat in the water by removing any tie-down straps, disconnecting tail light connections, and attaching a line to the bow eye fitting. If you are using an outboard, be sure that the outboard unit is trimmed up. Be sure to reinstall the bilge drain plug if it has been removed.
- To launch, back the trailer into the water to a point where the boat will clear the bottom. Stop and secure the vehicle.
- Unlock the winch line from the boat. Push the boat into the water and have your assistant guide the boat with the bow line.
- Once the boat is cleared of the trailer, pull your vehicle out of the water and park it.

Reloading Procedures

To reload, repeat the unloading procedures in reverse. Other important tips to remember are:

- Try to idle coast onto the trailer; do not power onto the trailer.
- When pulling the boat onto the trailer, be sure the boat is centered as much as possible. The distance between the boat and runner board should be approximately equal on both sides.
- Make sure the boat is securely in place before moving the trailer.

Warning Labels

Warning labels are displayed at various locations throughout your new Axis to point out safety hazards. It is important that you take the time to locate these labels. Do not remove or cover warning labels. Replace when illegible.

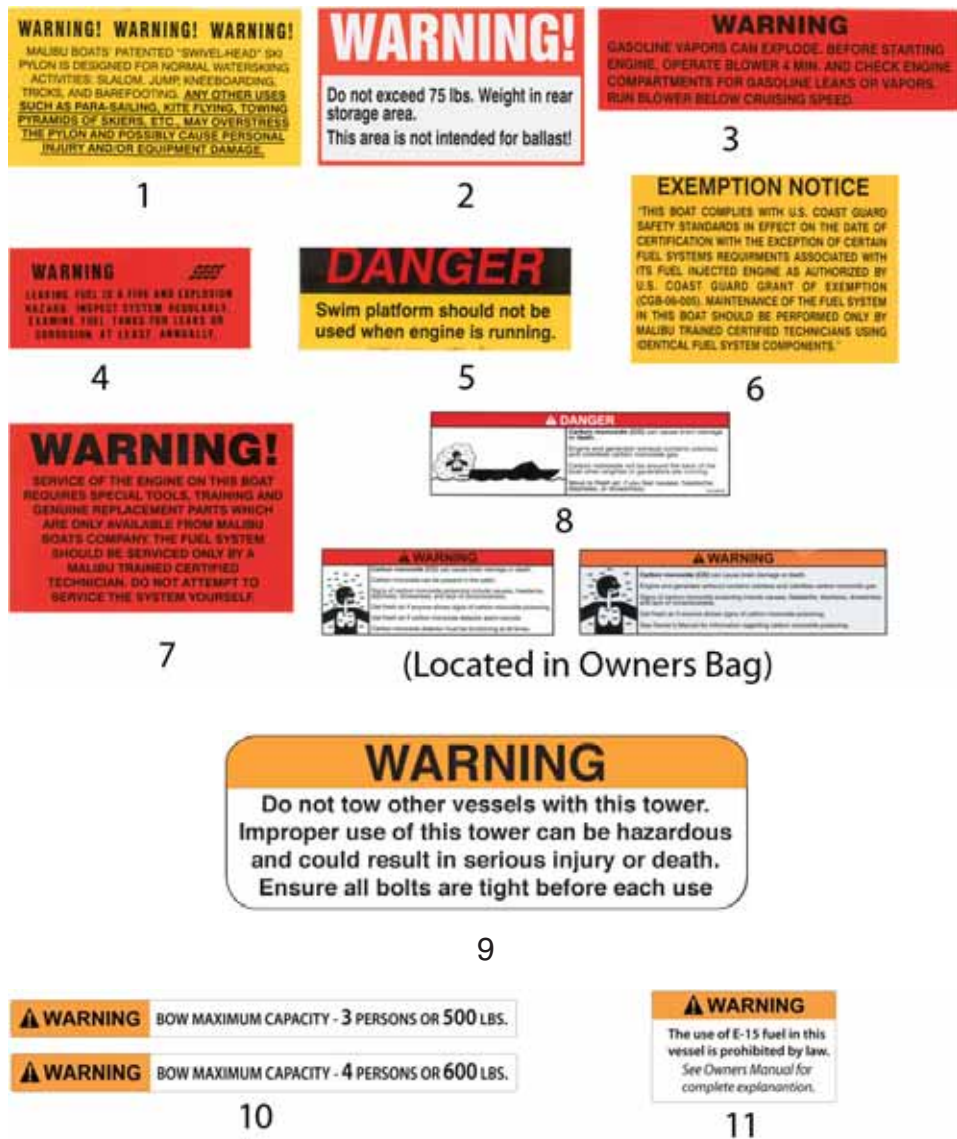
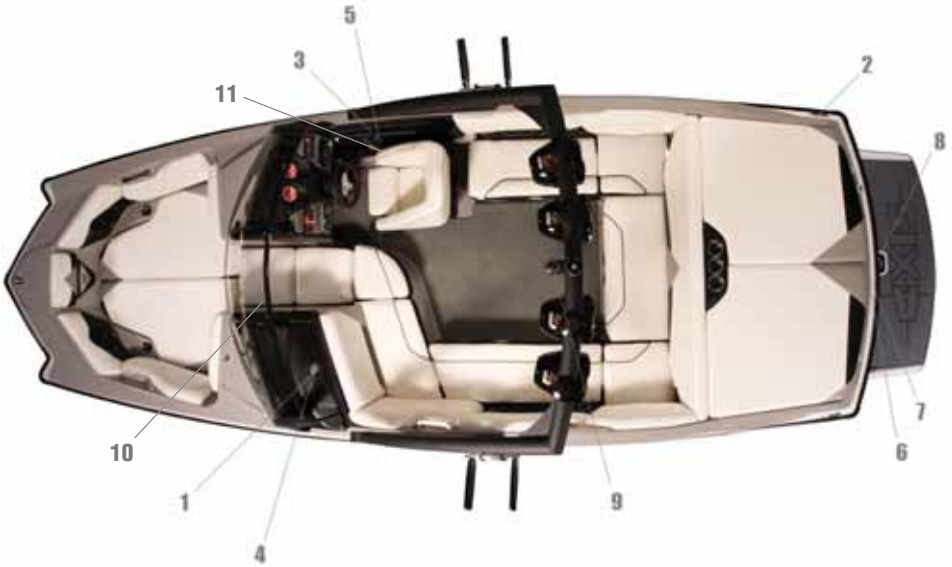

Figure 3-5. Warning Labels

Refer to the diagram below for the location of each label.



Warning Labels: _____

Load Capacity

The U.S. Coast Guard and most maritime authorities require that boats under 20 ft have a certification or builder's plate stating the number of persons and maximum weight a boat will handle safely under normal conditions. Weather conditions and other factors can adversely affect the performance of the boat and must be taken into consideration when loading to avoid an unsafe condition. The certification is attached near the helm forward of the throttle. Overloading is a violation. Do not carry more weight or passengers than indicated on the plate. The presence of the plate does not relieve the owner/operator from responsibility for using common sense and sound judgment.



Figure 3-6. Sample Capacity Plate

Occupants must ensure that ALL weight in the boat is evenly distributed to prevent unsafe operation. Care must be taken to ALWAYS avoid creating a “bow heavy” or any other unsafe condition. If in doubt contact an authorized Malibu service center. Do not allow anyone to sit on the back of the boat, swim platform, side of the boat or any other non-approved seating area while the engine is running or the boat is in motion.

Caution



Never exceed the load capacity and distribute weight evenly between bow and stern, and port to starboard.

Caution



SWAMPING HAZARD

Overloading may reduce the stability and seaworthiness of the boat.

- The weight of all persons and gear including non-factory fitted ballast bags, water bladders, ballast tanks and fat sacks should never exceed the maximum weight capacity listed on the capacity label specified by the U.S. Coast Guard or your local maritime authority.
- Add the weight of water contained in non-factory installed ballast bags or tanks to the weight of the persons and gear. When determining total weight on board, calculate the weight of water at 9 lbs/gal (1.1 kg/L).

Axis Wake Research reminds you that when your boat is fully loaded with the maximum number of persons and gear as indicated on the capacity plate, boat speed and performance will be affected. Operate a boat in this condition with extra care.

Axis Wake Research designs and engineers our boats to have the best possible performance at sea level with factory-installed equipment. For this reason, it is likely your boat can be equipped or loaded in a way that can restrict its performance when operated at higher elevations. Not all available options may be able to be utilized under these conditions. Consult your dealer for more information.

Fueling

It is very important to take special precautions to avoid spillage while fueling your boat. Gasoline vapors are heavier than air and will develop in the lower cavities of the boat, such as the bilge.

Warning



Do not allow the fuel tank to empty completely during operation. Doing so may damage the fuel pump. Damage from running fuel systems empty is not be covered under standard warranty.

Below is a list of guidelines you should follow when fueling your boat:

- 1) Extinguish all cigarettes and other flame or spark producing items.
- 2) Make sure all power is off, and do not operate any electrical switches.
- 3) Be sure to wipe off any spillage that may have occurred.
- 4) Operate the bilge blower for a minimum of four minutes before starting the engine.

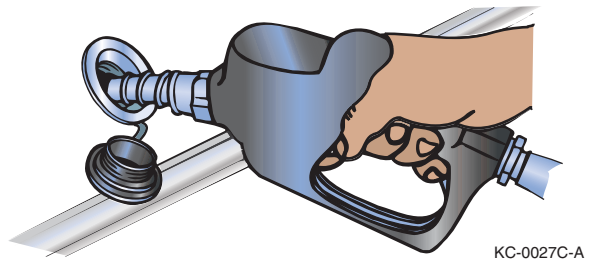

KC-0027C-A

Figure 3-7. Fueling

Caution



Do not overfill fuel tank. The fuel tank will expand and contract based on weather conditions, and can cause fuel to spill out the fuel exhaust vent. Damaged caused to your boat from leaking fuel due to overfilling is not covered by your warranty.

Starting

First Start-Up of the Day

On the first start-up of the day, you may find it beneficial to “key up” once or twice to prime the fuel system prior to cranking the engine to start. The fuel system pressure will drop after a few hours of non-use. To prevent long crank times when starting for the first time, turn the key ON once to prime the fuel system.

This is a “High Pressure” fuel system. If you ever smell a strong fuel odor, shut down immediately and inspect for leaks.

Notice: The PIT fuel system is not to be serviced by anyone other than an Axis Factory Trained and Certified Technician. Special tools and training are required to service this fuel system.

Pay close attention to the information regarding the break-in period listed in your engine owner’s manual. Top engine performance is dependent upon following the guidelines listed.

Pre-Start Checklist

A routine pre-starting procedure should always be carried out before the first start-up of the day. Below is a list of basic, necessary checks to perform before starting your engine.

- 1) Replace drain plugs.
- 2) Check oil and transmission fluid levels.
- 3) Check fuel supply.
- 4) Inspect the engine compartment for water or fuel leaks.
- 5) Operate bilge pump until bilge is dry.
- 6) Operate blower for a minimum of four minutes to expel fumes.

Starting the Engine

Axis boats are equipped with sensors that constantly monitor various functions of the boat. Certain functions, if outside of pre-determined operating parameters, may activate an alarm located under the dash. When the ignition key is turned ON, the alarm will sound to indicate it is operating. Once the engine is running, the alarm should be off unless a problem is detected. If the alarm sounds during operation, stop the boat as soon as possible and turn off the engine. Investigate and correct the problem before returning to operation. Pressing the ENTER button on the display will silence the alarm for four minutes. Following is a list of monitored functions that can activate the alarm:

Engine Oil Alarm:

- RPMs above 300 and below 1000 with oil pressure below 4 psi.
- RPMs above 1000 with oil pressure below 18 psi.

Engine Temperature Alarm:

- RPMs above 300 with temperature above 203° F. Alarm will reset when engine cools below 198° F.

Battery Voltage Alarm:

- Voltage drops below 11 V.
- Voltage is above 16 V.

Water Depth Alarm:

- Water is shallower than water depth alarm setting.

Refer to Section 4, *Care and Maintenance, Electrical*, for more information on the alarm. Please refer to your engine owner's manual for the proper starting procedures.

Shifting/Running

The throttle lever is located to the right of the driver. When the throttle is vertical, it is in the “NEUTRAL” position.

Located at the base of the throttle you will find the shift lock knob. Pulling outward on this knob disengages the transmission, thereby allowing for use of the throttle without engaging the transmission. This is used for warm-up of the engine in neutral. Be sure to position the throttle vertically (in neutral) before re-engaging the transmission by depressing the knob.

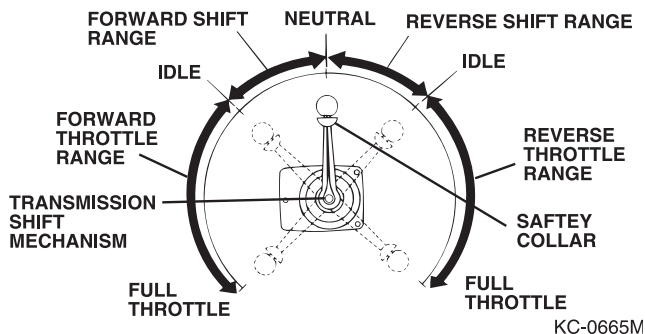

Figure 3-8. Throttle Positions

When engaging the transmission from neutral to either forward or reverse, you must pull up on the safety collar located directly below the throttle lever knob.

Notice: For more information regarding the safe operation and maintenance of the throttle control, refer to the separate instructions located in the information packet shipped with your boat.

Steering

It is important that you get the “feel” of your boat’s steering system. Turn the wheel from full left to full right, and make sure the rudder is turning accordingly. The system should operate freely and smoothly.

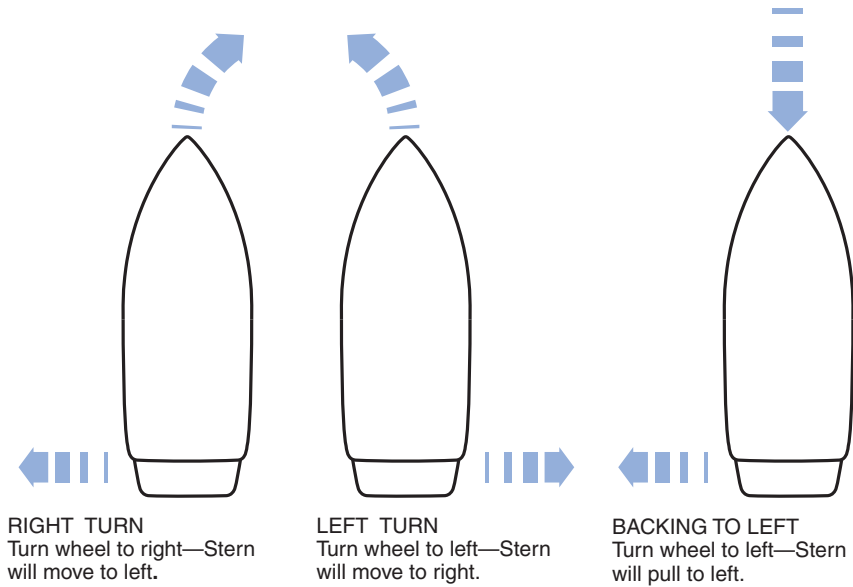

KC-0199-A

Figure 3-9. Turning with a Rudder

Warning



The steering system must be in good operating condition for safe boat operation. Frequent inspection, lubrication, and adjustment by your dealer is recommended.

All boats have a tendency to wander somewhat at slow speeds. A natural reaction to this effect is to steer the boat back and forth in an attempt to compensate for wandering. Invariably, the compensation will result in oversteer and only worsen the effect. Keep the steering wheel in the center position, the boat will wander back and forth somewhat, but the overall course will be a straight one.

Maneuvering Techniques

Steering response depends on three factors: engine position, motion and throttle.

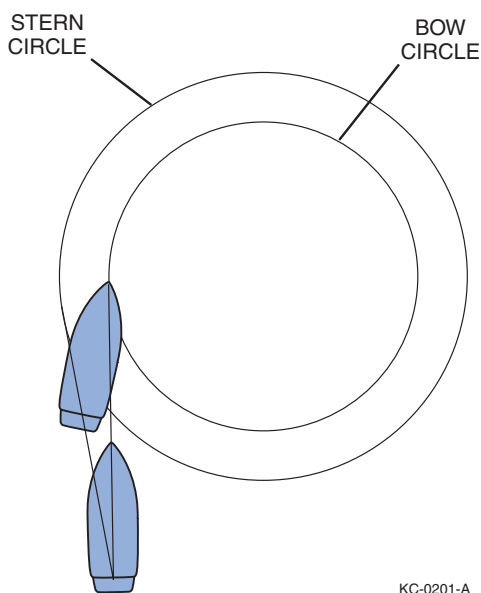

Figure 3-10. Stern Push

propeller-driven watercraft. A counterclockwise rotation propeller tends to cause the stern of the boat, steering in the straight ahead position, to drift to port when going forward, and to starboard when going backward. At high speed, this effect is usually unnoticed, but at low speed; especially during backing, it can be powerful. For this reason, many veteran boaters approach the dock with the starboard side of the boat toward the dock, if possible, since the stern of the boat will drift starboard when reverse thrust is applied.

Like an automobile, high speed maneuvering is relatively easy and takes little practice to learn. Slow speed maneuvering, on the other hand, is far more difficult and requires time and practice to master.

When making tight maneuvers, it is important to understand the effects of turning. Since both thrust and steering are at the stern of the boat, the stern will push away from the direction of the turn. The bow follows a smaller turning circle than the stern.

The effects of unequal propeller thrust, wind, and current must also be kept in mind. While wind and current may not always be present, an experienced boater will use them to his advantage. Unequal thrust is an aspect shared by all single engine

Stopping

When stopping the boat, it is important to remember there are no brakes to allow coming to a complete, immediate stop. To stop your boat, anticipate ahead of time and begin slowing down by pulling back on the throttle.

Once the throttle is in neutral and the engine has stopped pulling the boat forward, it may be necessary to pull the throttle into reverse to further slow the forward momentum of the boat. The reverse thrust of the engine will decrease the forward speed and slow the boat down to a safer maneuvering speed. Never shift the transmission into reverse if the boat is moving faster than 2 MPH (3.2 km/h).

Warning



Do not use the engine stop switch for normal shut down. Doing so may impair your ability to restart the engine quickly or may create a hazardous swamping condition.

Docking

Docking procedures for the new boat owner usually bring surprising results. Remember, operate your boat at slow speeds to avoid accidents and practice docking to gain experience and confidence.

Once away from the dock, practice docking in open water with an imaginary dock. Pull up to the dock at a slow rate of speed. Shift the boat into neutral and drift slowly toward the dock. Shift the boat into reverse slightly to slow or stop the boat altogether.

Warning



Never use your hand, arm or other part of your body between the dock and boat or attempt to keep the boat from hitting the dock. The boat could push against the dock, causing severe injury.

Follow these guidelines when docking:

- Approach docks with the starboard side of the boat if possible.
- Come to a stop a short distance from the dock, then proceed slowly.
- Have fenders, mooring lines and crew ready.
- Observe how the wind and current are moving your boat. Approach the dock with the boat pointed into the wind, if possible. If the wind or current is pushing you away from the dock, use a sharper angle of approach. If you must approach the dock downwind or down current, use a slow speed and shallow angle. Be ready to reverse to stop and maintain position.
- If there is no wind or current, approach the dock at a 10 to 20 degree angle.
- If possible, throw a line to a person on the dock and have that person secure a bow line.
- With the bow secure, swing the stern in with the engine, or pull it in with a boat hook.

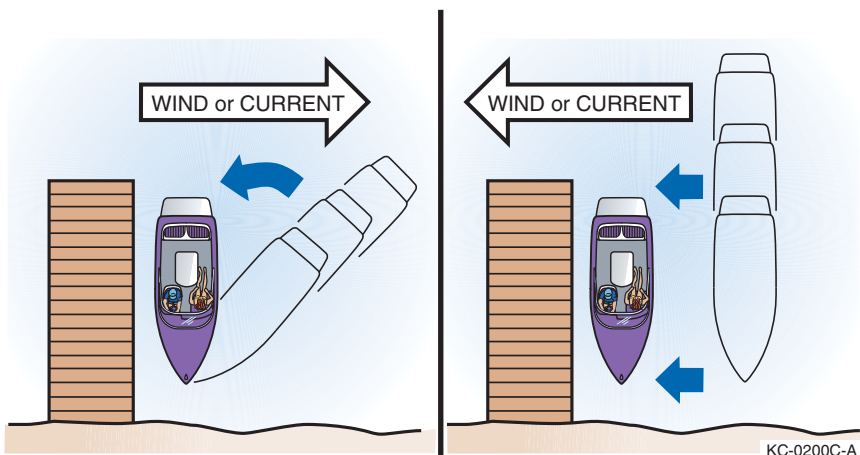

Figure 3-11. Docking with Wind/Current

Before tying up the boat, be sure to use enough fenders to protect the boat from damage. If possible, tie up with the bow toward the waves with a good-quality, double-braided nylon line. Tie up only to the lifting or tie-down eyes; never use the handrails or windshield frames. If the boat is to be moored for a long period of time, use chafing protectors on lines to protect the gelcoat finish. Leave a little slack in the lines to allow for some wave movement or tidal action if applicable.

The foredeck handrails should only be used for tying a “Jackline” in an emergency situation. If possible, tie up your boat with the bow toward the waves and leave a little slack in the lines to allow for movement from waves or the tide.

Follow these guidelines when departing:

- Very slowly shift into forward at idle speed.
- When the stern moves away from the dock, turn the engine away from the dock.
- Cast off bow line and back away.

If the wind or current is pushing away from the dock, cast off all lines and allow to drift until you are clear.

High-Speed Operation

A great deal of caution must be exercised when operating any boat at high speeds. This is particularly true during turns. Gradual turns can be completed at high speed by a competent driver, but it must be emphasized that sudden turns at any speed, particularly at high speed can be especially dangerous. It is possible to throw passengers from their seats and even from the boat if caution is not exercised.

Towing / Interacting with Skiers, Wakeboarders and Wake Surfers

Water skiing is a collective effort involving driver, observer and skier. The degree of understanding and cooperation between them directly determines the success and enjoyment of the venture. All must understand that the skier is an extension of the boat. The driver is no longer responsible for a boat that is 20 ft long, but closer to 95 ft. Once this is understood, you are underway to a safe and secure adventure together. A healthy respect for Common Sense Rules of water skiing safety on the part of the skier, driver and observer will ensure the risk of skiing accidents is kept to a minimum at all levels of participation.

Warning



Do not allow anyone to sit on the back of the boat, swim platform side of the boat or any other non-approved seating area.

A moderate ability to swim is advisable for waterskiers, but swimming ability is no substitute for a well-fitting life jacket. The wearing of a life jacket or personal flotation device (PFD) is essential even for expert swimmers. The jacket should be Type III, approved by the U.S. Coast Guard and designated as a ski jacket. The jacket should fit snugly, otherwise it could slip up over the skier if the skier should happen to fall at high speed.

Communication between the skier and driver is essential. Standard signals have been developed by the American Waterski Association and have been accepted by most waterskiers. Once the skier is in the water and ready, the driver of the boat will take the slack out of the tow line. When the skier is in position and prepared for lift, the skier shouts “hit it” which is the signal for the driver to open the throttle for take-off. Once the skier is on plane, there are a number of hand signals that will allow communication between the skier and the driver of the boat. A copy of these signals can be found for review at your local Axis dealership or by contacting USA Water Ski at (863) 324-4341 or online at www.usawaterski.org.

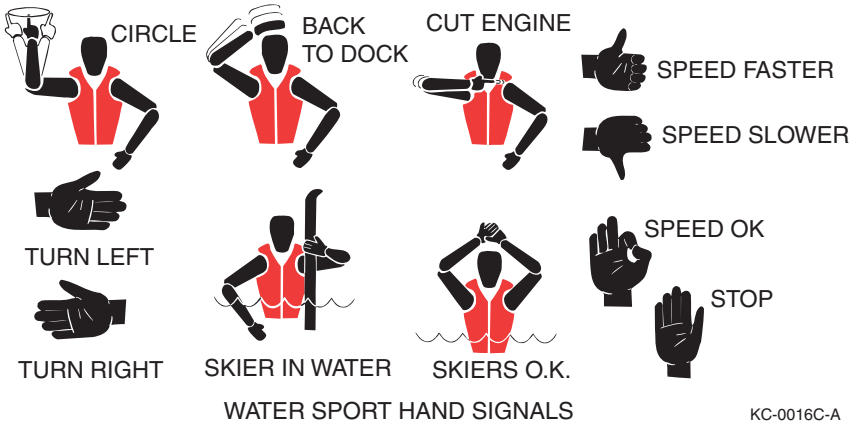

Figure 3-12. Hand Signals

Once a skier has fallen or is ready to quit skiing, the driver must be prepared for immediate removal of the skier from the water. The driver of the boat should keep the skier in line of sight as much as possible until the skier is reached. Once the boat is near the skier, the driver should always turn off the engine until the skier is onboard. There should be no exception to this rule as there is always the possibility of the skier slipping or falling back into the water risking contact with the boat propeller.

Warning



When retrieving a person in the water, the engine must be off. NO ONE should be allowed to swim or otherwise be in the water near the boat unless the engine is off. Never operate the boat in reverse to retrieve anyone in the water.

Towing Another Boat

Towing is normally a last resort because damage can be created by stress from the towing lines or uncontrollability of the boat being towed. Only when ideal conditions arise — lake is calm, the disabled boat is smaller than yours, and both boat operators know correct technique — should a recreational boat be towed by another.

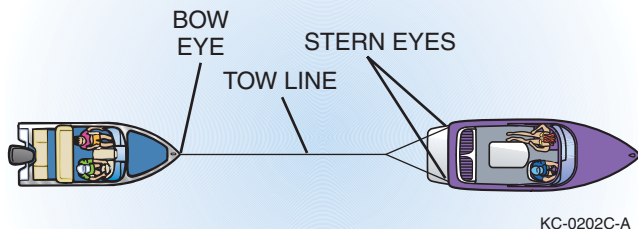

KC-0202C-A

Figure 3-13. Towing

Because the towing boat is the maneuverable boat and the grounded boat is not, you should pass the tow line to the grounded boat. Use double-braided line. Never use three strand twisted nylon; it has too much elasticity and can snap back dangerously. Fasten the towline as far forward as possible on the upwind or up current side of the boat being towed. Fastening it to the stern will restrict maneuverability. Attach the line to the stern lifting eyes of the towing boat. Keep lines free of propellers on both boats. Keep hands and feet clear of other boat and never hold towline after it is pulled taut.

Move slowly to prevent sudden strain on slack line.

Be ready to cast loose or cut the line if conditions become hazardous.

Anchoring

There are many types of anchors available on the market. The choice on which one to choose depends on the usage. Contact your dealer on what anchor would suit your situation.

Warning



Always anchor from the bow of the boat. The boat has less chance of breaking free if a heavy wind comes.

Propellers

Caution



- **A propeller can be very sharp. Be careful when you handle it. Wear a pair of protective gloves when handling any propeller.**
- **Remove your key from the ignition to prevent accidental starting of the engine.**
- **DO NOT reuse the nylon locknut or the cotter pin.**
- **DO NOT use a damaged propeller. A damaged propeller can damage your engine and/or your boat.**

Nothing is more important to the proper performance of your boat than the condition of the propeller. Even slight propeller damage can mean the loss of one MPH. Greater damage can mean considerably more speed loss. Worse yet, damage usually is not done to each blade uniformly and, therefore, sets up imbalanced vibrations that can cause fatigue damage to other parts of the engine or drive system.

Your propeller is custom calibrated for your Axis by our Research and Design team to give maximum performance. Before installing props other than those suggested by Axis Wake Research contact your dealer, otherwise adverse handling and top speed characteristics may be experienced. The prop is identified by two numbers, i.e., 13 x 14, and material identification such as brass or stainless steel. The first number is the diameter of the prop and the second is the pitch. The pitch is the angle of the blades and is measured in how far the boat will travel through the water in one revolution. In this case, for every one revolution the boat will travel 14 in.

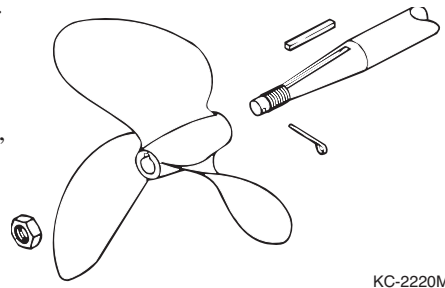

Figure 3-14. Propeller

Warning



Do not operate engine above the manufacturer's recommended RPM rating; severe damage could result, voiding the warranty.

At least once a year, more often if you use your boat extensively, you should have your local Axis dealer inspect the propeller for any possible damage.

At least once a month, if you use your boat regularly, you should check and tighten the prop nut. If it is necessary to remove the prop, use care. If the prop is not removed correctly, damage could result if it comes off the shaft too quickly and hits the ground. Whenever possible, use a prop pulling tool to remove prop, this will reduce the chance of damaging the prop.

Removal

- 1) Remove the cotter pin from the propeller shaft and discard.
- 2) Wedge a piece of 1" x 4" wood between the propeller blade and the starboard side of the strut and rudder.
- 3) Loosen the nylon locknut and unthread it until it is flush with the end of the prop shaft.
- 4) Use a propeller puller to separate the prop from the taper on the shaft. Holding the prop with one hand, remove the nylon locknut and discard.
- 5) Remove the propeller, then remove the key from the keyway. Inspect the keyways and key for any damage.

Installation

Before installing the prop, look at the keyway on the shaft and in the propeller. The key should slide freely in both keyways. **DO NOT** use the prop nut to advance the prop onto shaft.

If the key has slight damage or burrs, remove them by filing the flat sides or replace the key. **DO NOT** file the key beyond its normal shape or size.

- 1) Rotate the shaft until the keyway is "up."
- 2) Place the key in the shaft keyway. Align the keyway in the prop to the key. The prop will only slip on in one direction. Once the prop starts to go on the shaft, push the propeller "solidly" on the shaft and make sure you feel that it is seating properly.
- 3) Wedge a piece of 1" x 4" wood between the propeller blade and the port side of the strut and rudder.
- 4) Install a new nylon locknut and torque the nut to maximum of 30 ft-lbs (40.7 N•m).
- 5) Install new cotter pin. Bend the retaining ends of the cotter pin in the opposite directions. Make sure the cotter pin is snug and cannot rotate.

Axis Exclusive Adjustable Rudder System

Your Axis steering is custom calibrated at the Axis factory at the time of manufacturing. However, it may be necessary from time to time to adjust the steering due to normal operations. Axis Boats' unique adjustment feature allows custom calibration to your specific driving needs. The Axis Adjustable Rudder system allows you to increase or decrease the amount of load that is typically on the steering system.

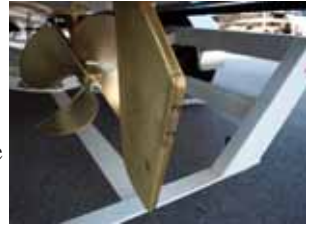

Figure 3-15.
Adjustable Rudder

If it is determined that your rudder needs adjustment, you can do so by adjusting tunable feature located on the trailing edge of the rudder surface. Locate the two hex-head retaining screws. Loosening the screws will release the adjustment tab. If your boat pulls to the right, slide the tab to the right 1/8th to 1/4". Do not move beyond this point. Only minor adjustments are needed to make a correction. Note that it may take more than one adjustment to get the desired setting. Tighten the hex-head screws when adjustment is completed.

Warning



Make sure the hex-head screws are tightened after each adjustment. Failure to tighten the screws could cause erratic steering and serious damage could result. If you are unsure of the correct procedure to conduct this adjustment, it is recommended that you return your boat to your local Axis Boat dealership for assistance.

Corrosion Protection

Galvanic corrosion (electrolysis), is the break-up of metals due to the effects of electrolytic action. When two dissimilar metals are immersed in a conductive fluid such as salt water, an electric current is produced, similar to that of a battery. As the current flows, it takes with it tiny bits of the softer metal. If not stopped, a great deal of damage can occur.

If you operate your boat in salt or brackish waters, you should have your boat equipped with a transom mounted zinc anode to prevent damage to the parts coming in contact with the water. The zinc anode being the softer metal will deteriorate and erode much faster than the other metals in the boat. Inspect the anode periodically and replace as needed. Consult your local Axis dealer for this part.

Saltwater Corrosion

If you use your boat in salt or brackish water, wash the entire boat, including trailer and tower (if fitted), thoroughly with a mild detergent and rinse with fresh water after EVERY USE. Apply a corrosion inhibitor to all hardware regularly. Consult your dealer for products suitable for the marine saltwater environment and proper usage instructions.

Axis strongly recommends freshwater internal engine flushing after using the boat in salt, polluted or brackish waters. Flush the entire cooling system with fresh water for at least five minutes after use in these waters. See your Axis dealer for appropriate flushing devices and additives.

Notice: Salt water is commonly very harsh on all components of boat. Saltwater corrosion is not covered under your Axis or Indmar warranties. It is the boat owner's responsibility to understand and ensure they have taken proper precautions to safeguard boat.

Chapter 4

CARE AND MAINTENANCE



The following guidelines discussed in this section will protect the investment you have made by preserving the beauty and performance of your new boat for years to come.

Interior

Carpet

Your Axis boat is equipped with a top quality, all-weather indoor/outdoor carpet. It is essentially waterproof and fade resistant. Occasional vacuuming and scrubbing with soap and water will remove embedded dirt and grit.

Gauges

Clean the gauges with mild, soapy water and a damp, soft cloth. Do not use window or glass cleaner on the gauge lenses.

Vinyl

All upholstery items aboard your boat are made of a tough marine vinyl that is easily cleaned with a mild detergent and warm water. After washing the vinyl, be sure to dry it thoroughly.

Our materials are mildew resistant, but there are no products available to us that are mildew proof. Therefore, we also recommend that you dry the upholstery thoroughly at the end of each day's boating activity to prevent mildew which will rot the upholstery threads and backing. We also recommend that you tip up all seat base cushions on edge after each use to allow any accumulated water to drain.

Warning



In some instances, color or dye transfer can occur when wet clothing comes in contact with vinyl. If this occurs, the vinyl should be cleaned immediately to avoid permanent staining. Unfortunately, due to the porous nature of the upholstery, you may find that the dye has set into the vinyl surface, and you cannot remove it. If this should occur, it is recommended that you contact Final Finish/MSG to get assistance in cleaning.

Upholstery finish stains caused by secondary sources are not covered under your Axis Boats Warranty.

It is important to keep your vinyl clean at all times. Some substances can stain the vinyl if you leave them on for even a short period. Remove any contaminant and clean the area immediately. Some household cleaners, powdered abrasives, steel wool, industrial cleaners, dry cleaning fluids and lacquer solvents can damage and discolor. Failure to care for your vinyl properly, or use of improper cleaners may damage the vinyl and void your warranty.

DO NOT use products such as acetone, ArmorAll®, bleach, baking soda, Fantastik®, Formula 409®, gasoline, kerosene, Murphy® Oil Soap, Simple Green®, Son of a Gun!® or any silicone based protectants. DO NOT clean your vinyl with power washers, as they can generate pressures up to 3,500 psi and could damage the surface of your interior.

Common stains and steps to treat:

Type of Stain	Step #1	Step #2	Step #3
General care	A	B	
Dirt buildup	A	B	
Ballpoint ink*	B	A	
Chewing gum	B	A	
Coffee, tea, chocolate	B	A	
Grease	C	B	A
Household soil	A	B	
Ketchup	A	B	
Latex paint	A	B	
Lipstick	C	A	B
Mildew or wet leaves*	B	A	
Motor oil	C	B	A
Oil-based paint	C	B	A
Permanent marker*	B	A	
Spray paint	B	A	
Suntan lotion*	A	B	
Tar/asphalt	C	B	A
Yellow mustard	A	B	

- a. Medium-soft brush, warm, soapy water, rinse/dry
- b. 303 Fabric and Vinyl Cleaner®, rinse/dry
- c. Wipe or scrape off excess (chill gum with ice)

After all cleaning methods, rinse well with clear, warm water.

* Suntan lotion, tree pollen, wet leaves and some other products, including waxes, can contain dyes that stain permanently.

Use only a damp, soft cloth with mild, soapy water to clean the in-dash graphical displays and switches. Ammonia-based or harsh chemical cleaners will damages the lenses.

Exterior

Your Axis boat is highly resistant to weathering, water pollution and minor scrapes which occur during normal use. However, regular care and maintenance of your boat is a general responsibility for all Axis boat owners. By following the boat care instructions listed below, you will be able to extend the life and beauty of your Axis boat.

Fiberglass and Gelcoat

The fiberglass hull and deck of your Axis boat consist of a molded shell and exterior gelcoat. The gelcoat protects the fiberglass shell and gives all Axis boats a smooth and shiny surface. The following are some general instructions which will help you maintain your boat's sleek appearance:

- 1) Wash monthly or more frequently, depending on use. Use a mild dish washing soap and lukewarm or cold water. Rinse your boat with fresh water and wipe down immediately to avoid water spots.
- 2) Wax the boat hull and deck after every three or four outings to decrease water friction and to lessen the potential for staining or spotting the gelcoat surface. In cases where the original gelcoat shine cannot be restored by waxing, hand buff the surface using any commercial compound. Be sure to apply several coats of wax over the area that has been polished.

Surface Stains

Stains can appear as a result of dust, road tar, plant sap, rust from metal fittings and other materials coming in contact with your boat's exterior. Listed below is a step-by-step procedure to remove stains from your boat:

- 1) Wash area with dish washing soap
- 2) Apply a mild cleanser on a small area (3 x 3 ft)
- 3) Rinse with fresh water
- 4) Buff with a fine rubbing compound
- 5) Wax

If the stain is not removed by the dish washing soap or mild cleanser, then the next procedure is to use either denatured or rubbing alcohol. Common rubbing alcohol is excellent for removing stains.

Scratches

Scratches to the gelcoat sometimes occur during normal use. Your dealer can usually restore the gelcoat to like-new condition.

Underwater Corrosion

Corrosion occurs in saltwater conditions from the interaction of the saltwater and the direct current of the battery. To prevent corrosion, it is important to keep the bilge area as dry and clean as possible.

Care for Boats that are Moored

Due to gelcoat discoloration, osmosis (blistering) and algae growth, it is not recommended that you leave your boat moored for long periods of time. If your boat will be moored in fresh water or saltwater for extended periods of time, you should do the following:

- 1) Haul-out and clean your boat regularly (every 14 to 21 days). Use soap, water and plenty of elbow grease.
- 2) Apply wax after cleaning.

You should also check with your local Axis dealer about anti-fouling paint and other products that can be applied to the hull bottom below the water line.

Engine/Drive Train

Engine

For information on engine service, maintenance and break-in period, please refer to your engine owner's manual. The Required Maintenance Schedule included in this manual covers the minimum maintenance required for Indmar engine packages. The Maintenance Worksheet included in this manual outlines safety checks, lubrication and general service that should be performed at regular intervals. It is recommended that any engine replacement parts used for maintenance or repair be supplied by an authorized Axis dealer.



Figure 4-1. AR335 MPI Engine

Engine Specifications

Axis Engines		
Engine Models	AR335 MPI / AR335 ETX/CAT / AR335 ETX/CAT Saltwater	LS3
Number of Cylinders	V-8	
Displacement	350 CID (5.7L)	364 CID (6.0L)
Bore/Stroke	4.0012 x 3.480 in. (101.63 x 88.39 mm)	4.000 x 3.622 in. (101.6 x 92 mm)
Compression Ratio	9.4:1	
Compression Pressure ¹	Minimum 100 PSI (690 kPa)	
Idle RPM in Neutral ²	650 ± 50 RPM	
Operating Range at WOT	4600-5200 RPM	5200-5600 RPM
Oil Pressure at Idle	4 PSI (41 kPa) Minimum Hot	
Oil Pressure at 2000 RPM	18 PSI (124 kPa) Minimum Hot	
Oil Filter	Pennzoil PZ3, AC-PF25	Pennzoil PZ52, AC-PF25
Fuel Pump Pressure	60 PSI Minimum at Keyup (414 kPa)	
Electrical System	12 Volt DC Negative (-) Ground	
Min. Battery Requirements	650 cca/700 mca/120 Ah	
Firing Order	1-8-4-3-6-5-7-2	1-8-7-2-6-5-4-3
Spark Plug Type	AC 41-932 or 41-993	AC 41-110
Spark Plug Gap	.060 in. (1.5 mm)	.040 in. (1.02 mm)
Base Timing at 1000 RPM ³	Nonadjustable	
Thermostat	160°F (71°C)	
Fluid Capacities		
Crankcase (with Filter) ⁴	5.5 Quarts (5.25L) with Filter	6.0 Quarts (5.7L)
Closed Cooling System ⁵	12-14 Quarts (11.4-13.3L)	
ZF Ski Vee Transmission ⁴	2.12 Quarts (2L) Main Gearbox, 1.0 Quart (1.06L) V-drive – Dexron 3	
Indmar Vee Drive Transmission	2.0 Quarts 10 oz (2.2L) (Front) ATF Dexron 3, Dexron 6 or equivalent, 1.0 Quart 8 oz (1.2L) (Rear) Mobil Del Vac Synthetic Transmission Fluid 50 or equivalent	

Notes

- 1) Minimum recorded compression in any one cylinder should not be less than 70% of the highest recorded cylinder.
- 2) Measured using an accurate shop tachometer at normal operating temperature. Idle RPM on EFI models is not adjustable.
- 3) Timing must be set using special procedures indicated in the appropriate service manual. Timing cannot be set using conventional methods. Special tool(s) required.
- 4) Always use dipstick to determine exact quantity of oil required. Do not fill above “FULL” mark.
- 5) Do not over fill. Correct level is at the “Full Cold” mark on the coolant recovery bottle when coolant is cold.

Transmission

Check fluid only with engine OFF and boat floating level, or level on trailer. The transmission dipstick is located on the top of the transmission. Dipsticks may be marked “FULL” or “H” (high) and “ADD” or “L” (low); maintain fluid level between the two marks.

Caution



Check level immediately after turning engine off. Transmission fluid may be hot. Be careful not to burn yourself.

TRANSMISSION	CAPACITY	FLUID TYPE
ZF Ski Vee	2.12 qt (2L)	Pennzoil Dexron III
Indmar Vee Front	2.0 qt 10 oz (2.2L)	ATF Dexron 3 or Dexron 6 or equivalent
Indmar Vee Rear	1.0 qt 8 oz (1.2L)	Mobil Del Vac Synthetic Trans. Fluid 50 or equivalent

Caution



Do not overfill the transmission. Overfilling can damage the transmission. Damage to your transmission due to too much or too little fluid is not covered by your warranty.

Operate boat approximately five minutes to warm the transmission fluid. Turn engine off and disconnect the engine safety switch. Ensure throttle is neutral.

Notice: Check immediately after shutdown to prevent incorrect reading.

- Open engine compartment and locate transmission fluid level dipstick.
- Remove dipstick and wipe with a clean rag. Quickly re-insert the dipstick fully and immediately remove. Check the fluid level is at the full warm mark on the stick.
- Add or remove fluid as necessary to maintain the level at the mark. Use only recommended automotive transmission fluid. You will find recommended fluid types in your Indmar Owner’s Manual.

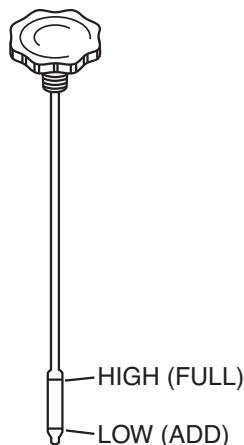

KC-2175

Figure 4-2. Typical Transmission Dipstick

Rudder Stuffing Box

The rudder stuffing box is a greaseless design and requires no regular maintenance.

Dripless Shaft Seal

Located in the bilge, under the rear center access panel, is the dripless shaft seal. This seal is where the prop shaft goes through the hull of the boat.

Prop Shaft/Engine Alignment

As per Indmar’s recommended routine service maintenance, it is necessary to regularly evaluate the prop shaft coupler bolts that attach the prop shaft to the engine. See Indmar Owner’s Manual for proper prop shaft alignment. If the prop shaft bolts loosen prematurely, major damage to your boat structure and driveline could result. It is recommended that only a trained service technician perform this maintenance due to the complications that can arise from an improperly balanced prop shaft engine alignment.



Figure 4-3. Dripless Shaft Seal

Warning



Damaged caused from loosened coupler bolts and improper engine alignment is not covered under your Axis Boats warranty, and should be part of the owner’s service responsibilities to ensure system is correct. See Axis Boats and Indmar Owner’s Manuals for appropriate timelines for evaluation or checkup.

Fuel System

Fuel System

All Axis Boats are equipped with Pump-in-tank (PIT) fuel systems. This means the fuel pump is no longer mounted on the engine and is now located in the fuel tank. There are many benefits to using Pump-in-Tank; most notably is the prevention of vapor lock and improved filtration of contaminants.

This is a “High Pressure” fuel system. If you ever smell a strong fuel odor, shut down immediately and inspect for leaks.

Warning



The PIT fuel system is not to be serviced by anyone other than an Axis Factory Trained and Certified Technician. Special tools and training are required to service this fuel system.

Do not use fuel containing more than 15% MTBE. Also, fuel containing more than 10% ethanol or grain alcohol is not recommended. A higher percentage of either of the two fuel additives can cause damage to the engine and fuel system.

DO NOT mix MTBE and ethanol. Drain your tank, or use up as much of the old fuel as you can before making the switch to E10. Once done, do not go back to MTBE gas. Also, drain the tank when storing the boat, and put in additives.

Does the gas you are buying have ethanol or MTBE? By law, roadside stations must put stickers on pumps designating whether the gas has ethanol and how much. A lot of marinas do not put up stickers, so ask.

Find out when your fuel provider switched to E10 and how it was done. Old fuel and water should have been removed and the tanks cleaned to reduce the possibility of the ethanol loosening up old sludge. If they mixed ethanol with gas, you could be pumping a potential disaster into your boat.

Mixing the two additives can and will cause damage to the engine and fuel system which will void all warranties supplied by Axis Wake Research, and Indmar Engine Company.

Refer to the engine owners manual for further information.

Electrical

Engine Circuit Breaker

Your engine is equipped with a 35 AMP Circuit Breaker to protect the engine electrical system and components from overload, and is found on the lower right side of the engine. If your engine should lose power and will not crank, reset the breaker by firmly pressing the red button (an audible sound will be heard). For additional engine electrical issues, see your Indmar Engine Owners Manual, or contact your Local Axis dealership.

Main Circuit Breaker

Located adjacent to the battery is a 80 AMP Circuit Breaker. If your boat's systems lose electrical power, and you have no dash gauges or your engine does not turn over, you will need to reset the breaker to restore power to your boat's systems. To reset, find breaker switch and depress until lever locks into position.



Figure 4-4. Main Circuit Breaker

Warning



Power loss to the Main Breaker is an indication of serious issues to your boat's electrical and/or engine components. Contact your local dealer for evaluation of these components.

Caution



If additional loads are added to the dash feeder circuits, such as amplifiers, tower lights, etc., this can overload the 80 AMP breaker. Large loads over 20 AMPS should be wired directly to the battery with proper overload protection.

Boat Alarms

Axis boats are equipped with sensors that constantly monitor various functions of the boat. Certain functions, if outside of pre-determined operating parameters, may activate an alarm located under the dash. Both the engine Electronic Control Module (ECM) and the dash gauge computer may activate the alarm.

If the ECM activates the alarm, it will store a trouble code in memory. Stop the boat as soon as possible and turn off the engine. You will need to have your Axis dealer run a diagnostics test to repair the engine and clear any codes from memory. The ECM uses the engine oil pressure, engine temperature and transmission temperature switches for input and parameters are stored in the ECM.

If the dash gauge computer activates the alarm, the Multi Function Display Panel will indicate the source of the problem. If the alarm sounds during operation, stop the boat as soon as possible and turn off the engine. You will need to have your Axis dealer run a diagnostics test to repair the engine and clear any codes from memory. The dash gauge computer uses a separate set of sending units on the engine, fuel tank and depth transducer for input and parameters are stored in the computer.

Refer to Section 3, *Operation, Starting*, for more information on the alarm.

Battery

A minimum of 650 cold cranking amps is the recommended battery size.

Warning



Do not connect battery cables to incorrect Terminal Post ±. Doing so may cause a reverse polarity current to run

through your electrical system and cause damage to your engine and other electrical components. Damage done to your boat due to incorrect terminal placement is not covered under your Axis warranty.

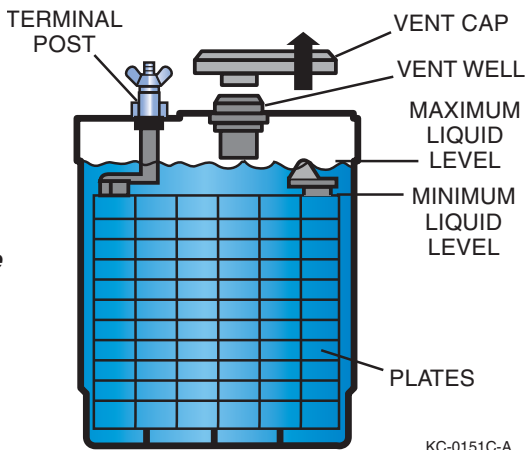

Figure 4-5. Battery Level

Check your battery terminals frequently for corrosion and tightness. Clean terminals with a baking soda and water solution and a wire brush. Also, check the fluid levels in the cells. Usually, a level approximately 1/4 to 1/2 in. above the plates is sufficient. If needed, fill with distilled water. Some batteries are sealed and this process is not necessary. Read directions when applicable.

Electrical Distribution-Battery Switches:

All main engine battery cables are the larger, 2/0 size. Always use a Starter/Cranking battery, minimum size of 650 Cold Cranking Amps on the big cable. This is the starter or cranking circuit.

There are also a set of smaller #2 AWG battery cables with the positive/red coming from an 80-AMP main circuit breaker (on the smaller boats, a #6 AWG cable and a 60-AMP main breaker). These smaller cables are the feeder circuit to the boats breakers and switches. These are referred as the House circuit.

#1 on a Single Battery System:

Both the cranking circuit and the house circuit are connected to the same battery. One battery running everything all connected together.

#2 on a Dual Battery System:

With a battery selector switch commonly called a “battery isolator switch”; both the house and the cranking circuits are always connected together at the selector switch. You have the ability to switch between 1-2 or all of the batteries to connect to the house and starter circuits. The current to charge the batteries, will come from the starter circuit, flowing from the engine alternator to the battery switch common terminal. When the engine is running you will have the ability to charge either #1 or #2 or both of the batteries at the same time. When the engine is off, you will pull current for both the house and cranking circuit on which ever battery you have selected or both batteries.

With this system you are required to manage the battery system, keeping both batteries charged and never run the second battery dead. Sitting listening to an amplified stereo system with the selector switch on “all” with lights on can drain both batteries. The best feature of this switch is you can disconnect the electrical system of the boat and engine, and the amperage draw for the computers and stereo memory during long and short term storage will be minimal. To maintain optimum performance, make sure to manage the batteries properly.



Figure 4-6. Battery Switch

Battery Isolator Switch

This option provides the ability to isolate the boat batteries if more than one battery is used. If so equipped, the isolator switch is located behind the front observer’s seat under the dash next to the battery. Under normal situations, the switch should be in “POSITION 1” or “POSITION 2” rather than in the “ALL” position. This will keep one battery charged should one of the batteries fail.

Circuit Breakers and Fuses

Most electrical standard equipment devices are controlled with circuit breakers. These breakers will activate if overloaded and cut power to the switch. To restore power, simply push the breaker button in and release. Breakers do not require fuse replacement. The breaker panel can be found under the dash next to the 12-V adapter. The stereo, if so equipped, has an inline fuse. If your stereo should quit working, check fuse as well as the breaker.

12-V DC Accessory Outlets

All models are equipped with two 12-V DC Accessory Outlets; one on the electrical panel below the dash, and one in the port side cupholder panel. These outlets provide power from your boat battery to accessory equipment such as cellular phones, video cameras, marine spot lights, etc.

Miscellaneous

Hardware

Most of the metal hardware on your boat consists of brass, stainless steel, or aluminum and should be cleaned on a periodic basis with soap and water. In fresh water, metal fittings and hardware should be sprayed regularly with a rust inhibitor, and after every use in saltwater.

DO NOT use cleaners that are not intended for use on stainless steel. Glass, tile, counter or citrus cleaners can damage hardware permanently. Always follow cleaning, by applying a high-quality metal polish or automotive wax after cleaning. Test products in an inconspicuous area before applying to the complete surface, especially if you are not familiar with the product.

All metal parts, including but not limited to tower accessories, board racks or speaker cans, should be cleaned with mild soap and water frequently and waxed periodically. A corrosion protectant is highly recommended on these components for use in areas of salt/brackish water. Pitting or oxidation is not covered under warranty. Pitting is not the same as separation.

Bilge

The bilge of your boat can accumulate oil and greasy dirt over a period of time and should be cleaned out periodically. Usually, ordinary soap and water does not remove the accumulation and something stronger will be needed. Check with your Axis dealer for recommendations.

Windows and Windshields

The windows and windshields on your Axis boat are made of tempered safety glass and are similar to the windows in your car. The glass will scratch however, and abrasive cleaners should not be used to clean your windows. Soap and water or automotive glass cleaners may be used.

Winterizing

When the boating and ski season comes to an end, it is recommended that the boat be removed from the water and stored. It is extremely important that proper winterizing procedures are read and followed to ensure longer boat life. Here is our list of suggestions to keep your boat in top condition:

- Prepare the engine according to the instructions found in your engine owner's manual. It our recommendation that you contact your local Axis dealer for full winterization procedures.
- Clean and dry the boat interior and exterior thoroughly. Inspect boat hull for residue and remove any if present.
- Clean the bilge area thoroughly and operate the bilge pump to remove any water from bilge lines.
- Remove all seat cushions and open all storage areas. Store the seat cushions in a cool and dry place.
- Cover the boat and store it in a garage or other protected facility.
- If the boat is stored on a trailer, you should block the trailer wheels.

Storage and Winter Lay-up

Due to the problems that can occur from improper winterization, we recommend that you take your boat to a certified Axis dealership to perform this task. Without proper preparation, storage for long periods of time may cause parts of the engine and transmission to rust due to lack of lubrication. Also, if your boat will be stored in freezing conditions, water inside these components to include cooling system, heater and shower could result in major damage to your boat. Damage done due to improper winter storage will void your warranty. Here is our list of suggestions to keep your boat in top condition.

Prior to boat being removed from water:

- Fill fuel and add 1 ounce of **STA-BIL**[®] fuel stabilizer for each 5 quarts of gasoline.
- Operate boat for at least 15 minutes in water or using a flush system to allow treated fuel to flush engine.
- Add lightweight engine oil (SAE-10 or fogging oil) slowly to the engine while engine is slightly above idle. Turn engine off. Consult your local dealer for correct procedure.

To be completed when boat is put on trailer or resting cradle:

- Remove bilge T-handle and transom drain plug immediately after removing from the water.
- Clean and dry the boat interior and exterior thoroughly. Inspect boat hull for residue and remove if present.
- Clean bilge area thoroughly and operate the bilge pump to remove any water from bilge lines.
- Remove all seat cushions and open all storage areas. Store the seat cushions in a cool dry place.
- Apply coat of wax to entire surface of boat.
- Flush engine-cooling system with clean water. Do not exceed 1500 RPM while flushing for 5-10 minutes.
- Turn fuel supply line to the OFF position (handle perpendicular to fuel line). Perform annual scheduled maintenance. Refer to engine owner's manual for complete engine winterization procedures as well as scheduled maintenance.

Note: Damage done due to improper engine winter storage will void your warranty. It is highly suggested that you allow a trained Axis technician to perform this service.

- After performing engine winterization, remove engine safety switch and spin engine over a few seconds to remove excess water found in pump bodies.
- Remove the negative cable from battery. Charge battery to full charge and remove from boat.
- Clean all traces of dirt, oil and grease from engine, transmission and bilge. Coat all areas on transmission and engine where paint has been removed with touchup paint.
- Use duct tape to seal the exhaust flaps closed to prevent dirt and rodents from entering exhaust.
- Remove propeller assembly, and store in safe place.
- If your boat is equipped with an optional heater or hot-water shower, remove both hoses and blow through hose to remove excess water.
- Cover the boat with cover, tarp or, if available, shrink-wrap tarp. Also, due to the excess weight that can occur from rain and snow for boats that are stored outside, it is suggested that you make a support of 2 inch PVC piping that can be mounted under the covering material. The rounded PVC piping will ensure the cover does not tear and will eliminate pooling water inside boat.

Winterization Re-Commission

- Remove boat cover or shrink-wrap from boat.
- Remove Duct tape from exhaust flaps.
- Charge and install battery in boat. Follow all safety precautions associated with changing batteries.
- De-winterize engine using engine manufacturer's specifications.
- Check propeller shaft alignment. Tighten coupling hardware.
- Check engine compartment for nesting animals. Clean as needed.
- Reinstall seat cushions from storage.
- Check entire engine for signs of cracks caused by freeze damage. Check all hose clamps for tightness. Install bilge drain plugs: transom, T-handle plug and ski locker drain plug.
- Reinstall propeller assembly.
- If not performed during winterization, perform annual maintenance at this time.
- If boat is equipped with optional fresh-water cooling, and was drained at winterization, fill at this time.
- Turn key on and off 2-3 times to allow fuel to return to engine, then start engine. When engine starts, watch gauges closely, and watch for abnormal readings.

Troubleshooting

The following charts will assist you in finding and correcting minor mechanical and electrical problems with your boat. Problems are listed in the order of the most likely event to the least likely.

To correct a problem, first determine what the problem is. Start with the first cause and eliminate the possibility of each until the problem is corrected. Because of the specialized skills and tools needed to correct major issues, we have not included that information. If you suspect a problem not listed here, please contact your Axis dealer.



PROBLEM	POSSIBLE CAUSE	SOLUTION
Engine will not turn over	<ul style="list-style-type: none"> • Throttle control in gear. • Main circuit breaker open. 	<ul style="list-style-type: none"> • Shift into neutral. • Reset circuit breaker.
Engine turns over, but will not start	<ul style="list-style-type: none"> • No fuel in tanks. • Contaminated Fuel. • Distributor Problems. 	<ul style="list-style-type: none"> • Fill fuel tank. • See your dealer. • See your dealer.
Engine is hard to start	<ul style="list-style-type: none"> • Flooded engine. • Plugged flame arrestor. • Fouled spark plugs. • Loose coil or ignition wires. • Battery cables loose or corroded. • Weak battery. • Ignition problems. 	<ul style="list-style-type: none"> • Start engine full throttle and back off. • Clean flame arrestor. • Replace spark plugs. • Tighten coil or ignition wires. • Clean and tighten battery cables. • Charge or replace the battery. • See your dealer.
Engine misses or idles rough	<ul style="list-style-type: none"> • Fouled spark plugs. • Loose or defective high-tension leads. • Plugged PCV valve. • Weak ignition coil. • Vacuum leak. 	<ul style="list-style-type: none"> • Replace spark plugs. • Tight or replace the high-tension leads. • Replace PCV valve. • Replace ignition coil. • See your dealer.
Poor boat performance	<ul style="list-style-type: none"> • Fouled spark plugs. • Plugged flame arrestor. • Weak ignition coil. • Contaminated fuel. • Fuel filter clogged. • Ignition problems. 	<ul style="list-style-type: none"> • Replace spark plugs. • Clean the flame arrestor. • Replace the ignition coil. • See your dealer. • See your dealer. • See your dealer.
Poor gas mileage	<ul style="list-style-type: none"> • Fouled spark plugs. • Plugged flame arrestor. • Inefficient driving habits. • Plugged PCV valve. • Ignition problems. 	<ul style="list-style-type: none"> • Replace spark plugs. • Clean the flame arrestor. • Plan the boat quickly, then slow down to desired speed. • Replace PCV valve. • See your dealer.

PROBLEM	POSSIBLE CAUSE	SOLUTION
Throttle/shifting problems	<ul style="list-style-type: none"> • Corroded cables. • Defective throttle return spring. • Low transmission oil level. • Sticking transmission shift detent ball. • Kink in cables. 	<ul style="list-style-type: none"> • Clean and lubricate cables. • Replace the throttle return spring. • Replenish the transmission fluid. • Clean and lubricate detent ball. • Replace the cable(s). See your dealer.
Steering problems	<ul style="list-style-type: none"> • Corroded cables. • Rudder worn. 	<ul style="list-style-type: none"> • Clean and lubricate the cable. • See your dealer.
Excessive vibration.	<ul style="list-style-type: none"> • Damaged propeller. • Misaligned propeller shaft coupling. • Bent propeller shaft. 	<ul style="list-style-type: none"> • Replace the propeller. • Check the alignment. See your dealer for proper realignment. • See your dealer.
Electrical problems	<ul style="list-style-type: none"> • Open circuit breaker or blown fuse. • Loose wire connections or corrosion. • Defective sending unit. • Shorted wiring harness. • Defective switch or gauge. 	<ul style="list-style-type: none"> • Reset the circuit breaker or replace the fuse. • Clean and tighten wiring connections. • Replace the sending unit. • Repair the wiring harness. • See your dealer.
No speedometer	<ul style="list-style-type: none"> • Paddle Wheel. • Defective speedometer. 	<ul style="list-style-type: none"> • Replace the paddle wheel. • Replace the speedometer.
Incorrect speedometer	<ul style="list-style-type: none"> • Paddle Wheel. • Defective speedometer. 	<ul style="list-style-type: none"> • Replace the paddle wheel. • Replace the speedometer.

Glossary

AFT:	To the rear of the boat near the stern. Generally used to give directions.
BEAM:	The widest portion of the hull.
BILGE:	The lowest portion inside the boat. This is generally the section directly below the engine compartment.
BOW:	The forward portion of the boat.
BULKHEAD:	Vertical portion in a boat.
CHINE:	The intersection of the sides and bottom of a “V” bottom boat.
DEADRISE:	The degree of angle from the keel to the chine.
DECK:	Upper structure which covers the hull.
DRAFT:	Vertical distance from the waterline of the boat to the lowest part of the boat.
FibECS II:	An engine mounting method, using fiberglass instead of other materials such as aluminum or steel; patented by Axis Boats LLC. that provides major reduction in noise and vibration.
FIBERGLASS:	Fibers similar to wool or cotton, but made from fibrous glass. Glass fiber forms include cloth, yarn, mat, milled fibers, chopped strands, roving and woven roving.
GELCOAT:	A surface, either colored or clear, providing a cosmetic enhancement and exposure improvements to a fiberglass laminate.
GUNNEL:	The upper edge of a boat’s side.
HELM:	Device attached to rudder for steering a vessel.
HULL:	The bottom section of the boat.
KEEL:	The lowest most portion of the bottom of the boat.
LIFTING STRAKES:	Strips molded or attached to the surface of a hull designed to create lift as speed and pressure increase with the static water.
PORT:	To the left side of the boat, when facing the bow.
STARBOARD:	To the right side of the boat, when facing the bow.
STERN:	To the rear of the boat.
STRINGER:	Longitudinal members that are fastened inside the hull of the boat which provide structural integrity.
TRANSOM:	The area forming the stern, or rear, of a boat.
WAKE:	The track or path a boat leaves behind while in motion.
WORKING DECK	Floor within cockpit or bow area.

Index

- A**
- Anchoring 3-16
 - Axis Exclusive Adjustable Rudder System 3-19
- B**
- Basic Rules of the Road 1-9
- C**
- Carbon Monoxide 1-8
 - Certifications & Standards v
 - Circuit Breakers 2-4
 - Corrosion Protection 3-20
- D**
- Docking 3-13
 - Drain Plugs 2-12
 - Driver's Seat 2-8
- E**
- Electrical 4-9
 - Emergencies 1-6
 - Emergency Engine Stop Switch 2-7
 - Engine / Drive Train 4-4
 - Exhaust 2-13
 - Exterior 4-3
- F**
- Fueling 3-7
 - Fuel System 4-8
- G**
- General Precautions 1-1
 - Glossary 4-18
- H**
- Hazardous Conditions 1-7
 - High-Speed Operation 3-14
- I**
- Interior 4-1
 - Introduction v
- M**
- Miscellaneous 4-12
 - Model Features & Specifications vii
 - Motorbox Cover 2-7
- N**
- Navigational Lights 2-10
- O**
- Operation by Minors 1-9
 - Optional Equipment 2-15
- P**
- Passenger Safety 1-9
 - Propellers 3-17
- R**
- Regulations 1-3
 - Responsibilities 1-3
- S**
- Safety Statements 1-2
 - Shifting / Running 3-10
 - Ski Pylon 2-9
 - Speedometer Pickup 2-12
 - Standard Gauges 2-1
 - Starting 3-8
 - Steering 3-11
 - Steering System 2-7
 - Stopping 3-12
 - Storage Areas 2-11
 - Sundeck 2-9
 - Swim Platform 2-10
 - Switches & Indicators 2-4
- T**
- Throttle Control 2-6
 - Tilt Steering Wheel 2-13
 - Towing Another Boat 3-16
 - Towing / Interacting with Skiers, Wakeboarders and Wake Surfers 3-14
 - Trailerage 3-1
 - Troubleshooting 4-15
- V**
- V-Drive Engine Access Hatch 2-9
 - Ventilation 2-14
- W**
- Warning Labels 3-4
 - Wedge 2-17

Maintenance Worksheet

Please circle one- Pre-delivery-/10hr.-/50hr.-/100hr.-/Annual

HULL NUMBER	OWNER NAME	PHONE NO.
-------------	------------	-----------

SERVICE DATE	WORK ORDER #	BOAT COLOR	SERVICE TECHNICIAN
--------------	--------------	------------	--------------------

INSTRUCTIONS

Please complete following; check each item as completed.

1. Inspect prop
2. Check engine alignment, motor mounts, and jam nuts
3. Check shaft packing
4. Service rudder (lubrication)
5. Check battery, battery hold down, cable connections
6. Check instrumentation
7. Check lights (bow, stern, and dash)
8. Check steering wheel cable fasteners, lubricate support tube and cable
9. Check control mechanism MV-2, MV-3 (freedom of movement)
10. Check neutral safety switch operation
11. Check security of fasteners (seat slides, seats, platform, interior handles)
12. Check all fuel connections (engine, tank, pump, filter)
13. Check engine exhaust clamps
14. Change engine oil and filter
15. Change transmission fluid/ filter
16. Change V-Drive oil (clean screens / magnetic plugs)
17. Inspect belts
18. Inspect impeller
19. Clean / change flame arrester
20. Check engine coolant (closed cooling only)
21. Check trailer: wheel lugs, lights, and loading bar
22. Inspect and lubricate wheel bearings
23. Check brake fluid level (if applicable)

LAKE TEST

1. Perform Diacom data list scan
2. Check PROM ID and record in customer file
3. Check fuel pressure and log reading
4. Verify oil levels (engine, Trans, V-Drive)
5. Verify blower operation, check hose attachment
6. Verify bilge pump operation and float control
7. Check for engine / boat water leaks
8. RE-check fuel connections
9. Verify neutral safety switch operation
10. Check for presence of vibration
11. Verify instruments operate properly
12. Verify controls operate properly (IE; steering, shifter)
13. Verify options function properly (IE; heater, shower etc.)

I certify that all checks have been performed and completed, this vessel has been prepared in conjunction with Axis Boats specifications.
To ensure proper warranty status, Boat/ Engine MUST receive recommended maintenance schedule.

Technician Signature _____ Date _____
Service Contact _____ Phone _____

Customer Signature _____
PLEASE RETAIN IN CUSTOMER FILE FOR FUTURE REFERENCE

Required Maintenance Schedule Indmar Engines

Item No.	Service	First 10 hours	Every 50 hours	Every 100 hours	Annually
1.	Change engine oil and filter Pennzoil Marine 15W-40, Pennz #PZ-3, AC PF-25	***	***		***
2.	Change transmission oil and filter Dextron III w/Mercon				***
3.	Ski Vee ATF				***
4.	Change fuel filter, Motor / Gas tank				***
5.	Change Spark plugs Indmar Engines MUST use AC MR43LTS or 41-932 Platinum				***
6.	Engine tune up (Cap, Rotor, Plugs)				***
7.	Clean for change flame arrester			***	
8.	Inspect belts, hoses and clamps Tight?	***			***
9.	Shaft alignment Within .003	***			***
10.	Inspect spark plug wires				***
11.	Inspect Raw water pump impeller (change annually)			***	***
12.	Inspect rudder (lube, key-way, bolt tight)		***		***
13.	Inspect Prop Shaft Packing	***			**
14.	Inspect Steering Kit Assembly (Lube, bolts tight?)		***		***
15.	Check Engine Coolant (closed cooling only) 50:50 mix water w/ethylene glycol MUST meet GM 6038				***
16.	Propeller Tight (prop nut tight? key-way installed?)	***	***	***	***7
17.	Lubricate starter bendix (Lithium marine grease)	***	***		***



Notes



AXIS WAKE RESEARCH LIMITED WARRANTY

Thank you for choosing to purchase an Axis Wake Research (“Axis”) product manufactured by Malibu Boats, LLC (“Malibu Boats”). Axis and Malibu Boats are committed to assuring your satisfaction with your new Axis boat. Malibu Boats will provide for repairs to your boat during the applicable warranty periods in accordance with the following terms, conditions and limitations.

Warranty Coverage – Summary

The warranty coverages are summarized below. Please refer to the warranty details that follow for complete terms, conditions, and limitations.

Axis Wake Research Limited Warranty	
Coverage Type	Coverage Period
Base Limited Warranty	24 Months Total (12 Months Parts and Labor + 12 Months Parts ONLY)
Tower Structural Limited Warranty	24 Months Total (12 Months Parts and Labor + 12 Months Parts ONLY)
Tower Cosmetic Limited Warranty	12 Months
Gelcoat Limited Warranty	12 Months
Hull Limited Warranty	Lifetime

In addition to the Axis Wake Research Limited Warranty, your boat also comes with other limited warranties provided by the engine and trailer manufacturers, among other items. Please refer to their limited warranty disclosures for details, including their terms, conditions and limitations.



Limitations and Disclaimer of Implied Warranties

ANY IMPLIED WARRANTY THAT IS FOUND TO ARISE BY STATE OR FEDERAL LAW, INCLUDING ANY IMPLIED WARRANTY OF MERCHANTABILITY OR ANY IMPLIED WARRANTY OF FITNESS, IS LIMITED IN DURATION TO THE DURATION SET FORTH IN THIS LIMITED WARRANTY OR THE DURATION SET FORTH BY APPLICABLE STATE OR FEDERAL LAW, WHICHEVER IS SHORTER. MALIBU BOATS DISCLAIMS ANY IMPLIED WARRANTIES, INCLUDING ANY IMPLIED WARRANTY OF MERCHANTABILITY OR ANY IMPLIED WARRANTY OF FITNESS, AFTER EXPIRATION OF THE WARRANTY PERIOD.

PERFORMANCE OF REPAIRS AND NEEDED ADJUSTMENTS IS THE EXCLUSIVE REMEDY UNDER THIS WRITTEN WARRANTY OR ANY IMPLIED WARRANTY. MALIBU BOATS SHALL NOT BE LIABLE FOR INCIDENTAL OR CONSEQUENTIAL DAMAGES, SUCH AS, BUT NOT LIMITED TO, LOST WAGES, SLIP FEES, TRANSPORTATION TO OR FROM REPAIR, OR RENTAL EXPENSES, RESULTING FROM BREACH OF THIS WRITTEN WARRANTY OR ANY IMPLIED WARRANTY.

Some states do not allow limitations on how long an implied warranty lasts or the exclusion of incidental or consequential damages, so the above limitation or exclusion may not apply to you.

Who Is Covered Under the Axis Wake Research Limited Warranty

Subject to all other terms, conditions, and limitations, original owners of the boat are provided coverage under the Axis Wake Research Limited Warranty. The warranty is not transferable to subsequent owners of the boat.

This Axis Wake Research Limited Warranty does not provide coverage for owners of boats manufactured in the United States by Malibu Boats, LLC and imported into Australia or New Zealand. This Axis Wake Research Limited Warranty does not provide coverage to any boat purchased from a dealer in another country, where the primary use of the boat will require the boat to cross an international border.



What “Is” Covered by the Axis Wake Research Limited Warranty

Coverages:

Base Limited Warranty

For a period of twelve (12) months beginning on the date the boat is purchased by the first retail purchaser through an authorized Axis sales facility, or, beginning on the date the boat was first put into service as a demonstrator or otherwise, whichever is earlier, Malibu Boats will repair, including parts and labor to perform such repair, substantial manufacturing defects related to materials or workmanship supplied by it during construction of the boat.

For a period of twelve (12) months immediately following the twelve (12) month period described in the paragraph directly above, Malibu Boats will provide the parts necessary to repair substantial manufacturing defects related to materials or workmanship supplied by it during construction of the boat. Malibu Boats nor Axis will not provide the labor nor reimburse for labor to perform such repair.

Tower Limited Warranty

For a period of twelve (12) months beginning on the date the boat is purchased by the first retail purchaser through an authorized Axis sales facility, or, beginning on the date the boat was first put into service as a demonstrator or otherwise, whichever is earlier, Malibu Boats will repair, including parts and labor to perform such repair, substantial manufacturing defects related to structural materials or structural workmanship supplied by it during construction and installation of the boat's tower.

For a period of twelve (12) months immediately following the twelve (12) month period described in the paragraph directly above, Malibu Boats will provide the parts necessary to repair substantial manufacturing defects related to structural materials or structural workmanship supplied by it during construction and installation of the boat's tower. Malibu Boats nor Axis will not provide the labor nor reimburse for labor to perform such repair.

Tower Cosmetic Limited Warranty

For a period of twelve (12) months beginning on the date the boat is purchased by the first retail purchaser through an authorized Axis sales facility, or, beginning on the date the boat was first put into service as a demonstrator or otherwise, whichever is earlier, Malibu Boats will repair substantial manufacturing defects related to cosmetic materials or cosmetic workmanship supplied by it during construction and installation of the boat's tower.

Gelcoat Limited Warranty

For a period of twelve (12) months beginning on the date the boat is purchased by the first retail purchaser through an authorized Axis sales facility, or, beginning on the date the boat was first put into service as a demonstrator or otherwise, whichever is earlier, Malibu Boats, conditioned on the owner having provided maintenance and care as described in the Axis Owner's Manual will repair substantial manufacturing defects related to materials or workmanship supplied by it in applying the Gelcoat finish to the boat. This Gelcoat Limited Warranty shall not include gelcoat finish, blistering, discoloration, fading or osmosis as well as damage due to in-water storage without proper barrier coat and bottom paints.

Lifetime Hull Limited Warranty

For the life of the boat, Malibu Boats will repair substantial manufacturing defects related to structural materials or structural workmanship supplied by it during the construction of the hull, deck, liner, stringer or upholstery frame.

All repairs performed by Malibu Boats, or an Axis authorized service facility, will be performed using either new or re-manufactured parts. Malibu Boats may, at its option, install parts which have similar or greater performance characteristics if an identical replacement part is no longer available. Repairs will be warranted only for the remainder of the original warranty period.

In addition to Axis Wake Research Limited Warranty, your boat also comes with other limited warranties provided by the engine and trailer manufacturers, among other items. Please refer to their limited warranty disclosures for details, including their terms, conditions and limitations.

What "Is Not" Covered by the Axis Wake Research Limited Warranty

The following are **NOT** covered under the Axis Wake Research Limited Warranty:

- Normal maintenance of boat, or any component thereof
- Normal wear and tear of boat, or any component thereof
- Damages caused by defects in materials, components or parts not supplied by Malibu Boats
- Damages or needed adjustments caused by items that are added, altered or changed after the boat leaves the possession of Axis, such as installation of aftermarket towers, tower accessories, ballast systems, barefoot booms, canvas accessories, and bottom painting
- Damages caused by accident (including impacts and collisions with any object), abuse, misuse, neglect, mishandling or alteration, including any damages caused by or during trailering or towing
- Damages caused by heat, fire, explosion or freezing (including the failure to perform proper winterization)
- Damages caused by the installation of non-Axis materials, components or parts



- Damages caused by lightning, hail, rain, flooding, wind, sand, floods or other environmental or natural conditions
- Damages caused by atmospheric fallout, chemical treatments, tree sap, salt, ocean spray, mold, or animal droppings
- Corrosion, oxidation, electrolysis including chrome plated, anodized or aluminum finish or colorfastness of finish (Exposure to a salt or brackish water environment can cause corrosion, or damage. Failure to rinse thoroughly after each use and apply a protective coating will void warranty.)
- Damages caused by aftermarket cleaning products or non-Axis approved additives
- Damages due to insufficient or improper maintenance, including use of oils, lubricants or fluids other than those recommended in the boat's Owner's Manual
- Conditions resulting from normal wear and tear
- Conditions resulting from use of the boat for anything other than recreational purposes
- Manufacturing variations or imperfections in cosmetic, convenience or aesthetic components or features of the boat, including the gelcoat finish, which have no effect on use, value or safety. Because the gelcoat finish is applied manually by a Malibu Boats craftsman, minor distortions or imperfections may be found in certain areas of the boat. Such distortions and imperfections are considered normal.
- Damages caused by the use of any trailer not sold through Axis
- Damages caused by improper support of the boat on davits, hoist system or boat lift of any kind
- Damages caused by overloading or overpowering the boat
- Any material, component or part of the boat that is covered by a warranty supplied by another entity
- Damages caused by water intrusion into any part of the boat (including the glove box)
- Gelcoat finish, blistering, discoloration, fading or osmosis as well as damage due to in-water storage without proper barrier coat and bottom paints (NOTE: Although Axis uses the highest-grade gel coat materials, a condition may develop where the bottom of the boat may show signs of discoloration and/or blisters if the boat is left in the water for long periods of time; therefore, a proper barrier coat and bottom paint should be used whenever it is anticipated that the boat will be left in the water for an extended period of time)
- Performance characteristics, such as speed, acceleration, fuel or oil consumption, etc., as they are estimated and can vary under numerous conditions
- Any and all consequential damages including, but not limited to, costs incurred for haul-out, launching, towing, and storage charges, telephone, expedited shipping of replacement parts, or rental charges of any type (including slip fees), inconveniences, or loss of time or income

The following events will discharge Axis and Malibu Boats from their obligations under the Axis Wake Research Limited Warranty:

- Unauthorized disconnection, tampering with, or altering of the boat's hour meter
- Unauthorized disabling of any Malibu Boat's installed warning device or system
- Unauthorized disconnection, disturbance or compromise of any wires, hoses, tubes, cables, looms or other components of the boat's electrical or fuel systems

- Determination by any state or federal entity or private insurance carrier that the boat is a total loss or fit only for salvage

This Axis Wake Research Limited Warranty does not provide coverage to any boat which has ever been: (a) a repossession from a retail customer; (b) purchased at auction (bank auction, online auction, auction house, etc.); (c) purchased from a salvage yard; (d) purchased from an insurance company that obtained the product as a result of an insurance claim.

The Axis Wake Research Limited Warranty does not cover the costs of maintenance, which include, but are not limited to, boat inspections, lubrication, engine tune-ups, replacement of filters, coolants, spark plugs, bulbs, fuses, impellers, packing materials, cleaning and polishing.

No oral or written information, advice or communication of any nature by or from Axis or Malibu Boats or their representatives, employees, dealers, agents, distributors or suppliers shall create a warranty or in any manner increase or modify the scope of this Axis Wake Research Limited Warranty in any manner whatsoever.

This Axis Wake Research Limited Warranty is expressly conditioned upon the timely completion and return of the warranty registration card to Axis.

How to Get Warranty Service

To obtain warranty service and/or repairs, you must do all of the following:

1. Notify Axis or Malibu Boats or an authorized Axis service facility of the substantial defect in materials or workmanship attributable to Malibu Boats, within thirty (30) days of discovery of the defect; and,
2. Promptly schedule an appointment with and deliver your boat to Malibu Boats or an authorized Axis service facility for repairs. Warranty service must be performed by Malibu Boats or an authorized Axis dealer. While not required, it is preferable that you deliver your boat to your selling sales and service facility. If you need assistance locating an authorized Axis service facility, please visit the Axis website at www.axiswake.com, email us at warranty@axiswake.com or call Axis at (209) 383-7469.

Please note that Axis authorized repair facilities, generally, are independently owned and operated businesses. Axis and Malibu Boats do not control the scheduling of service work. However, if you encounter any material delays in obtaining service at one of Axis authorized service facilities, please email or call Axis for assistance at warranty@axiswake.com or (209) 383-7469.



Important Additional Things to Know about the Malibu Boats Limited Warranty

In addition to the warranty terms and exclusions noted above, below you will find some additional important things to know about the Malibu Boats Limited Warranty:

Boat Operation, Care and Maintenance

To ensure that you receive the maximum benefit from your purchase and this limited warranty, Axis strongly recommends that you follow all of the instructions in the boat's operating manuals, including if applicable, any accompanying maintenance or service schedules. Because questions may sometimes arise relating to the cause of a particular failure, Axis strongly recommends that you keep detailed records of any maintenance or service performed on your boat so that you may be able to assist, if necessary, in the determination of whether a failure is covered under this Limited Warranty. Damages to your boat caused by improper operation, care and maintenance are not covered by the Axis Wake Research Limited Warranty.

Pre-Delivery Service

Defects and/or damage to the finish surfaces, trim, upholstery or other observable cosmetic components of your boat may occur at the factory. These items are usually detected and corrected at the factory or by the selling dealer prior to delivery to the retail customer. You are encouraged to inspect your boat for this type of damage when you take delivery. If you find any such defects or damage you must notify the selling Axis dealer at the time of delivery to have these items covered by this limited warranty and to have work performed on the items at no cost to you.

Design and/or Manufacturing Changes

Axis and Malibu Boats reserve the right to make changes in boats built by it at any time without incurring any obligation to make the same or similar changes on boats previously built and/or sold.

Other Warranties

Some materials, components or parts of the boat which are NOT covered by the Axis Wake Research Limited Warranty are separately warranted by their manufacturers or suppliers. These other warranties include, but are not limited to, warranties covering the engine, audio system, trailer, tires, mooring covers, batteries and Bimini tops. See copies of these other warranties for details relating to their terms, conditions and limitations.

Customer Satisfaction Procedure

Satisfaction with your boat is very important to Axis and Malibu Boats. Ordinarily all concerns related to your boat can be addressed by your authorized Axis service facility. If for some reason your concerns are not satisfied, the following steps should be followed:

First, ask to discuss your concern with a member of the authorized service facility's management. Ordinarily this will be the facility's service manager or service foreman. If your concerns already have been reviewed by the service manager or foreman, request to speak with the facility's general manager or owner.

Second, if your concerns are not resolved to your satisfaction by the representatives of the service facility, contact the Axis Customer Service Department at the address noted below. For the most helpful service, be prepared to provide your customer service representative with your name, address and phone number, your boat's hull identification number, the authorized Axis service facility or facilities at which your boat has been serviced, and the nature of the concerns you have with the boat or the service. Axis and Malibu Boats will thereafter provide assistance to you and the authorized service facility, as necessary, to resolve your concerns.

TO THE EXTENT PERMITTED OR REQUIRED BY ANY STATE OR FEDERAL LAW, YOU ARE REQUIRED TO PROVIDE MALIBU BOATS WRITTEN NOTICE, AT THE BELOW ADDRESS, OF ANY SUBSTANTIAL DEFECT IN MATERIALS OR WORKMANSHIP THAT REMAINS UNRESOLVED TO YOUR SATISFACTION UNDER THE TERMS OF THE MALIBU BOATS LIMITED WARRANTY, PRIOR TO INITIATING ANY LEGAL ACTION AGAINST MALIBU BOATS. TO THE EXTENT PERMITTED OR REQUIRED BY ANY STATE OR FEDERAL LAW, YOU MUST FIRST USE AN AVAILABLE STATE RUN INDEPENDENT DISPUTE SETTLEMENT MECHANISM OR ARBITRATION MECHANISM PRIOR TO INITIATING ANY LEGAL ACTION AGAINST MALIBU BOATS.

Contact Information:

Axis Wake Research
c/o Malibu Boats, LLC
Customer Service/Warranty Department
One Malibu Court
Merced, California 95340
(209) 383-7469

warranty@axiswake.com

Axis Wake Research Internet Site
www.axiswake.com

THIS WARRANTY GIVES YOU SPECIFIC LEGAL RIGHTS, AND YOU MAY ALSO HAVE OTHER LEGAL RIGHTS WHICH VARY FROM STATE TO STATE



Centered On You.

Tennessee Plant

Axis Wake Research

5075 Kimberly Way
Loudon, TN 37774

Phone: (865) 458-5478

Fax: (865) 458-9052

California Plant

Axis Wake Research

One Malibu Court
Merced, CA 95341

Phone: (209) 383-7469

Fax: (209) 383-0499

website: www.axiswake.com • email: info@axiswake.com