



malibu

---

## RECORD IMPORTANT INFORMATION

In addition to this manual, your Malibu Owner's Packet contains instructions, warranties and other important information from component manufacturers. Read these materials carefully since improper registration, operation and maintenance can void the warranty and jeopardize the safety of you and others. Fill in the information below and keep a copy of it in a safe place.

### Hull

HIN \_\_\_\_\_

Ignition Key # \_\_\_\_\_

Registration # \_\_\_\_\_

Date Purchased \_\_\_\_\_

Dealer/Phone \_\_\_\_\_

Fax/E-mail \_\_\_\_\_

### Engine

Model # \_\_\_\_\_

Serial # \_\_\_\_\_

### Transmission

Model # \_\_\_\_\_

Serial # \_\_\_\_\_

### Trailer

Model # \_\_\_\_\_

Serial # \_\_\_\_\_

### Accessory

Model # \_\_\_\_\_

Serial # \_\_\_\_\_

All information and specifications included in this manual were in effect at the time of approval for printing. Malibu Boats LLC reserves the right, however, to discontinue or change specifications or design at any time without notice and without incurring any obligation.

### **Trademarks**

Malibu, The Malibu Logo is a registered trademark of Malibu Boats LLC.

Indmar, Indmar is a registered trademark of Indmar Products Co., Inc.

All other product names are copyright and registered trademarks/trade names of their respective owners.

© 2000, 2001, 2002, 2003, 2004, 2005, 2006, 2007, 2008 Malibu Boats LLC.

All Rights reserved.

Printed in the USA

---



# CONTENTS

<b>CONTENTS</b> .....	<b>iii</b>
<b>TABLE OF FIGURES</b> .....	<b>iv</b>
<b>INTRODUCTION</b> .....	<b>v</b>
<b>CERTIFICATIONS &amp; STANDARDS</b> ... v	
<b>MODEL FEATURES AND SPECIFICATIONS</b> .....	<b>vii</b>
<b>BOATING SAFETY</b> .....	<b>1-1</b>
General Precautions .....	1-1
Safety Statements .....	1-1
Regulations .....	1-3
Responsibilities .....	1-3
Emergencies .....	1-6
Hazardous Conditions .....	1-7
Carbon Monoxide .....	1-9
Operation By Minors .....	1-10
Passenger Safety .....	1-10
Basic Rules Of The Road .....	1-10
<b>GAUGES &amp; CONTROLS</b> .....	<b>2-1</b>
Standard Gauges .....	2-1
Power Wedge .....	2-11
Circuit Breakers .....	2-13
Switches & Indicators .....	2-13
Throttle Control .....	2-17
Steering System .....	2-18
Emergency Engine Stop Switch ..	2-18
Motorbox Cover .....	2-18
Driver's Seat .....	2-19
Integral Self Draining	
Ice Chest .....	2-19
Sundeck .....	2-20
V-Drive Engine Access	
Hatch .....	2-20
Ski Pylon .....	2-20
Swim Platform .....	2-21
Navigational Lights .....	2-21
Storage Areas .....	2-22
Drain Plugs .....	2-22
Speedometer Pickup .....	2-23
Tilt Steering Wheel .....	2-23
Exhaust .....	2-24
Ventilation .....	2-25
Optional Equipment .....	2-26
Wedge .....	2-32
<b>OPERATION</b> .....	<b>3-1</b>
Trailerling .....	3-1
Warning Labels .....	3-4
Fueling .....	3-7
Starting .....	3-8
Shifting/Running .....	3-10
Steering .....	3-10
Stopping .....	3-12
Docking .....	3-13
High Speed Operation .....	3-14
Towing A Skier .....	3-14
Towing Another Boat .....	3-16
Anchoring .....	3-16
Propellers .....	3-17
Malibu Exclusive Adjustable	
Rudder System .....	3-18
Corrosion Protection .....	3-19
<b>CARE AND MAINTENANCE</b> .....	<b>4-1</b>
Interior .....	4-1
Exterior .....	4-3
Engine/Drive Train .....	4-5
Fuel System .....	4-11
Electrical .....	4-12
Miscellaneous .....	4-16
Troubleshooting .....	4-19
Glossary .....	4-22
Index .....	4-23

# TABLE OF FIGURES

Figure 1-1 Personal Flotation Devices . . . . .	1-5	Wheel Pickup . . . . .	2-23
Figure 1-2 Fire Extinguisher . . . . .	1-6	Figure 2-28 Tilt Steering . . . . .	2-23
Figure 1-3 Weather Hazards . . . . .	1-7	Figure 2-29 Heater . . . . .	2-26
Figure 1-4 Diver Down Flag . . . . .	1-8	Figure 2-30 Boat Cover . . . . .	2-26
Figure 1-5 Carbon Monoxide Hazards . . . . .	1-9	Figure 2-31 Stereo . . . . .	2-27
Figure 1-6 Types of Buoys . . . . .	1-11	Figure 2-32 Stereo Remote . . . . .	2-27
Figure 1-7 Mooring Buoys . . . . .	1-11	Figure 2-33 Stereo Functions . . . . .	2-27
Figure 1-8 Regulatory Markers . . . . .	1-11	Figure 2-34 Stereo Functions . . . . .	2-27
Figure 1-9 Crossing Situation . . . . .	1-12	Figure 2-35 Remote Control . . . . .	2-30
Figure 1-10 Overtaking Another Craft . . . . .	1-13	Figure 2-36 Shower Head . . . . .	2-31
Figure 2-1 Graphical Display . . . . .	2-1	Figure 2-37 Shower Valve . . . . .	2-31
Figure 2-2 Tachometer with Oil, Volt Hourmeter . . . . .	2-2	Figure 2-38 Pull-Up Cleat . . . . .	2-31
Figure 2-3 Speedometer with Depth, Air and Lake Temperature Gauge . . . . .	2-2	Figure 2-39 SaniPottie . . . . .	2-32
Figure 2-4 Dash Gauges . . . . .	2-3	Figure 2-40 Wedge Down . . . . .	2-32
Figure 2-5 In-Dash Display . . . . .	2-4	Figure 2-41 Wedge Up . . . . .	2-32
Figure 2-6 Cruise Control . . . . .	2-9	Figure 2-42 Scarpa Suppression Plate (SSP) . . . . .	2-33
Figure 2-7 BMS . . . . .	2-11	Figure 3-1 Trailer Hitch . . . . .	3-1
Figure 2-8 Power Wedge . . . . .	2-12	Figure 3-2 Safety Chains . . . . .	3-2
Figure 2-9 Circuit Breaker Panels . . . . .	2-13	Figure 3-3 Bow Tie-Down . . . . .	3-2
Figure 2-10 Accessory Switch Panel . . . . .	2-14	Figure 3-4 Transom Tie-Down . . . . .	3-2
Figure 2-11 MUX Switch . . . . .	2-16	Figure 3-5 Warning Labels . . . . .	3-4
Figure 2-12 Throttles . . . . .	2-17	Figure 3-6 Fueling . . . . .	3-7
Figure 2-13 Emergency Engine Stop Switch . . . . .	2-18	Figure 3-7 Throttle Positions . . . . .	3-10
Figure 2-14 Motorbox . . . . .	2-18	Figure 3-8 Turning With A Rudder . . . . .	3-11
Figure 2-15 Bolster Seat . . . . .	2-19	Figure 3-9 Stern Push . . . . .	3-12
Figure 2-16 Lumbar Adjuster . . . . .	2-19	Figure 3-10 Docking With Wind/Current . . . . .	3-13
Figure 2-17 Seat Adjuster . . . . .	2-19	Figure 3-11 Hand Signals . . . . .	3-15
Figure 2-18 Sundeck . . . . .	2-20	Figure 3-12 Towing . . . . .	3-16
Figure 2-19 Engine Access Hatch . . . . .	2-20	Figure 3-13 Propeller . . . . .	3-17
Figure 2-20 Pivoting-Head Ski Pylon . . . . .	2-20	Figure 3-14 Adjustable Rudder . . . . .	3-18
Figure 2-21 Swim Platform . . . . .	2-21	Figure 4-1 Typical Transmission Dipstick . . . . .	4-6
Figure 2-22 Swim Platform Pins . . . . .	2-21	Figure 4-2 Drip Less Shaft Packing . . . . .	4-10
Figure 2-23 Bow Light . . . . .	2-21	Figure 4-3 Main Circuit Breaker . . . . .	4-12
Figure 2-24 Lockable Transom Storage . . . . .	2-22	Figure 4-4 Battery Level . . . . .	4-13
Figure 2-25 Transom Drain Plug . . . . .	2-22		
Figure 2-26 Bilge Drain Plug . . . . .	2-23		
Figure 2-27 Thru-Hull Paddle			

# INTRODUCTION

Over the years, you have watched us grow into one of the most respected boat builders in the world. And undoubtedly, somewhere, you have run into at least one Malibu owner who proudly speaks of the “Malibu Difference.” That difference they so proudly speak of could be the special way we have serviced them over the years. We call it “going the distance.” Or maybe they are referring to the way their Malibu consistently outperforms other ski boats that they have driven. We can’t deny that we are different. Our passion for building the perfect ski boat is only surpassed by our commitment to total customer satisfaction.

This manual has been assembled to help you operate your new Malibu with safety and pleasure. Details of typical equipment as well as recommended safety and maintenance procedures about your boat are supplied. Please read carefully and familiarize yourself with the craft before using it.

We at Malibu Boats thank you for choosing us as your boat manufacturer and assure you that your satisfaction and boating enjoyment will continue to be our #1 priority.

# CERTIFICATIONS & STANDARDS

## **NMMA Certification**

Your Malibu boat has been built to meet or exceed the standards set by the National Marine Manufacturers Association (NMMA). NMMA verifies annually, or whenever a new boat model is introduced, to determine that they meet not only Coast Guard regulations, but also the more comprehensive standards set by the American Boat & Yacht Council (ABYC).

## **Standards To Which This Boat Was Built**

Your Malibu boat was built with the utmost care throughout the complete manufacturing process. The deck, hull, stringers and floor, as well as many accessory components, were built using our hand-laid composite fiberglass scheduling techniques. All boats receive complete quality control checks. Each boat is lake tested, and all information is kept on file at our factory for future reference.

## **Exemption Notice**

This boat complies with U.S. Coast Guard safety standards in effect on the date of certification with the exception of certain fuel systems requirements associated with its fuel injected engine as authorized by U.S. Coast Guard Grant of Exemption (CGB-06-005). Maintenance of the fuel system in this boat should be performed only by Malibu trained certified technicians using identical fuel systems components.

---

**Hull Identification Number (HIN)**

Your Hull Identification Number can be found on the starboard transom of your boat below the rubber rub rail. Federal law prohibits the tampering or removing of the number in any way. Use this number to register your boat with your local and state authorities.

US MB2GXXXXA001

**Proposition 65****Warning**

A wide variety of components used on this vessel contains or emits chemicals known to the state of California to cause cancer, birth defects and other reproductive harm.

**EXAMPLES INCLUDE:**

- Engine and generator exhaust
- Engine and generator fuel, and other liquids such as coolants and oil, especially used motor oil
- Cooking fuels
- Cleaners, paints and substances used for vessel repair
- Waste materials that result from wear of vessel components
- Lead from battery terminals and from other sources such as ballast or fishing sinkers

**TO AVOID HARM:**

- Keep away from engine, generator and cooking fuel exhaust fumes.
- Wash areas thoroughly with soap and water after handling the substances above.

**Emission Control Warranty Information**

The engine in your boat meets the strict requirements set forth by the California Air Resources Board (CARB). The engine has a special environmental tag and the boat has this label affixed to it. The tag and the label are required by the California Air Resources Board (CARB). The label has 1, 2, 3 or 4 stars. The label **MUST** be affixed to the boat, if the boat is operated in the state of California and/or bordering waters.





# MODEL FEATURES & SPECIFICATIONS

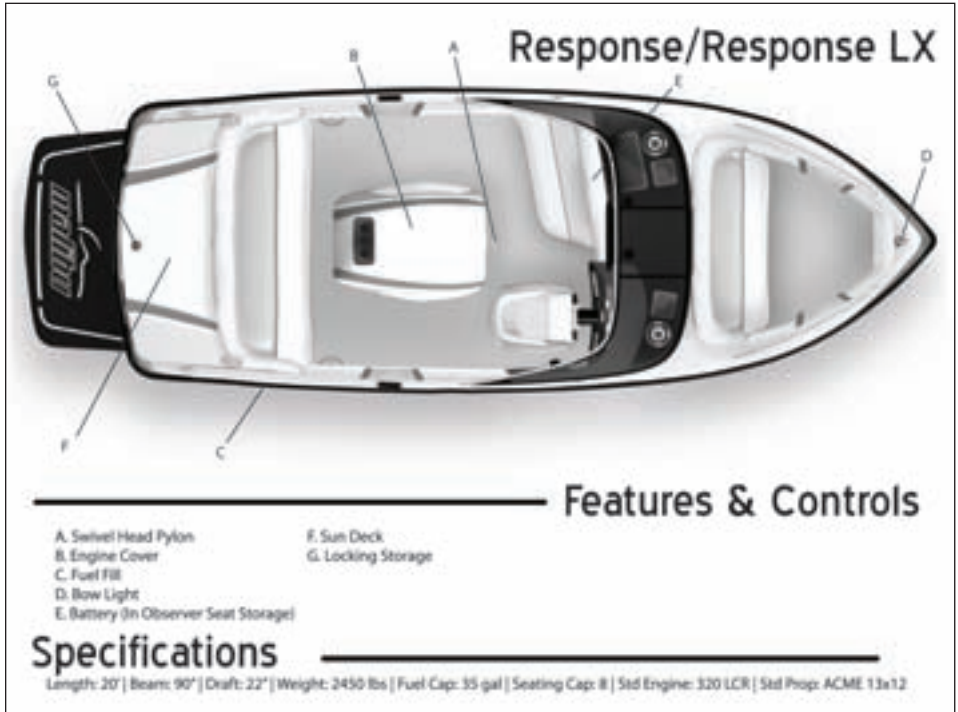

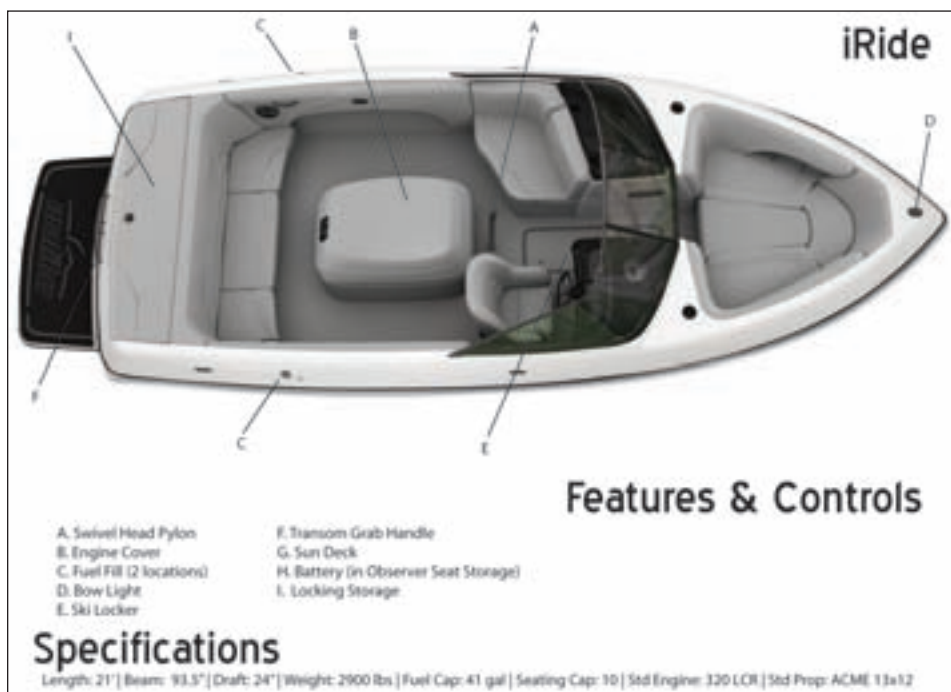
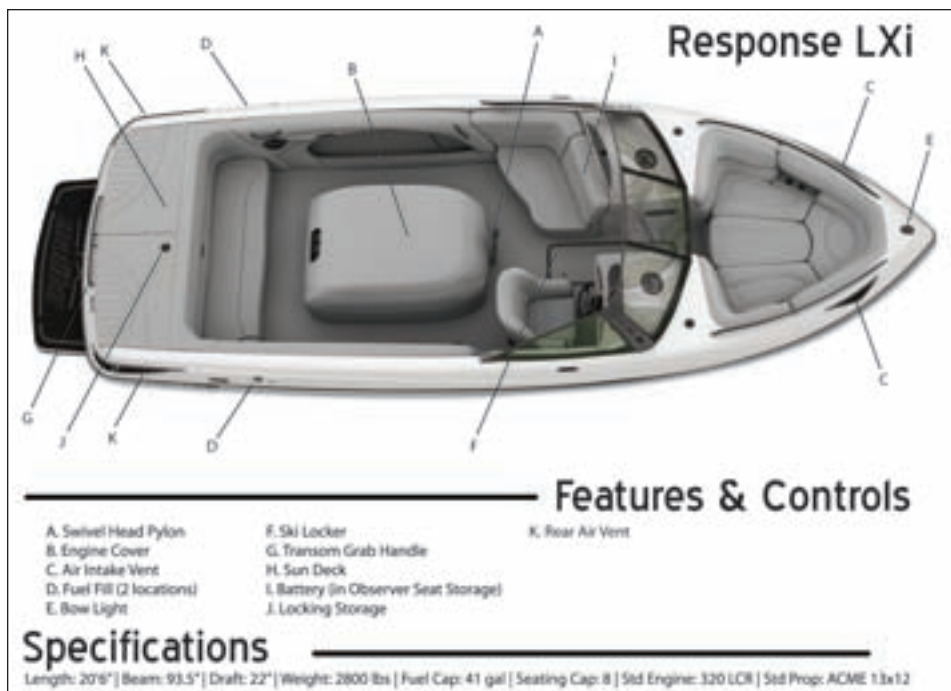

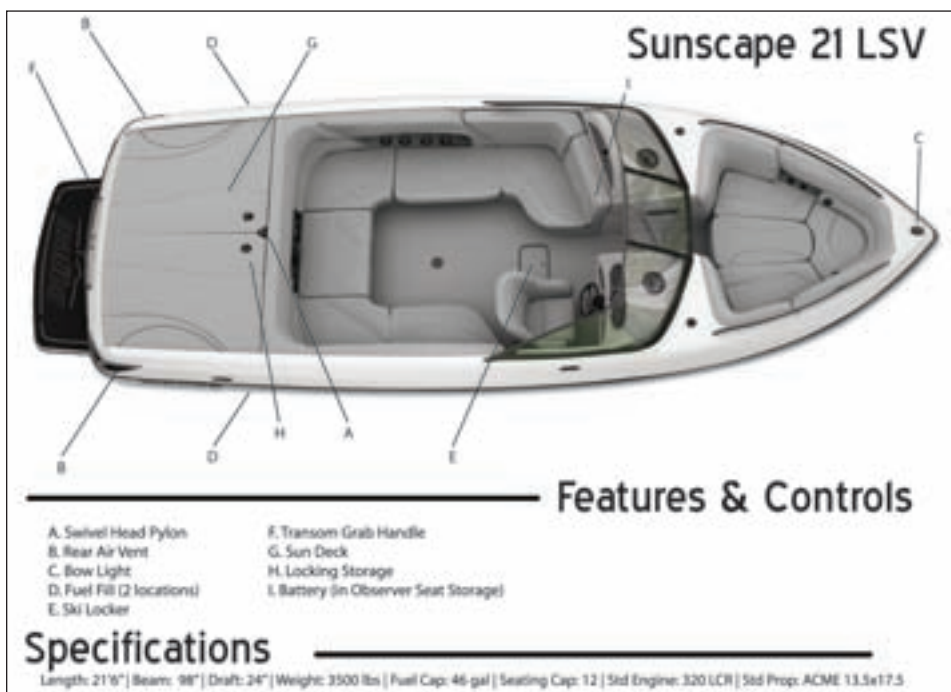
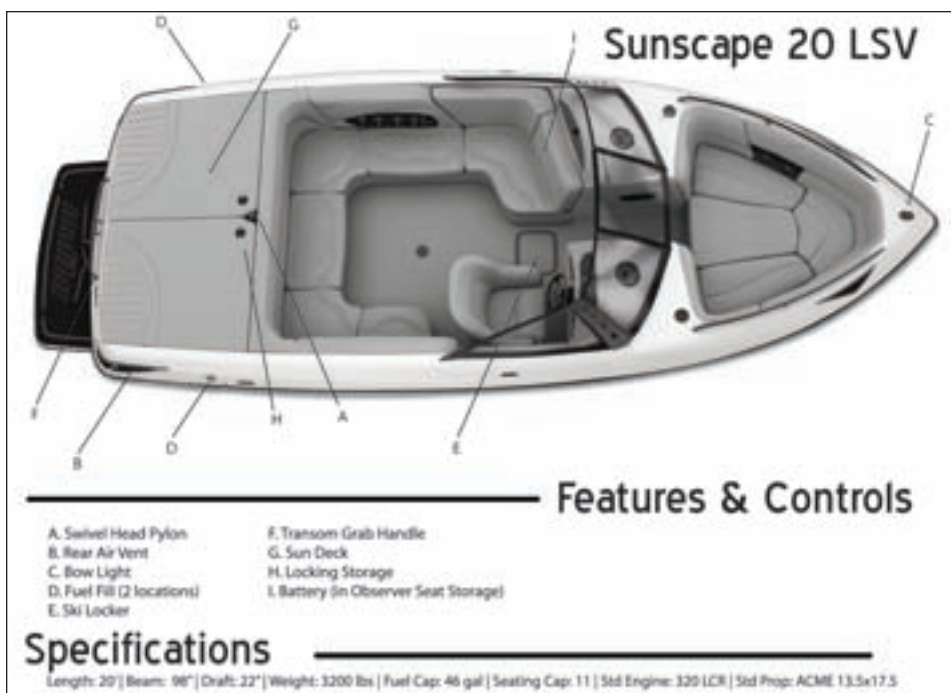

## Sunscape 23 LSV

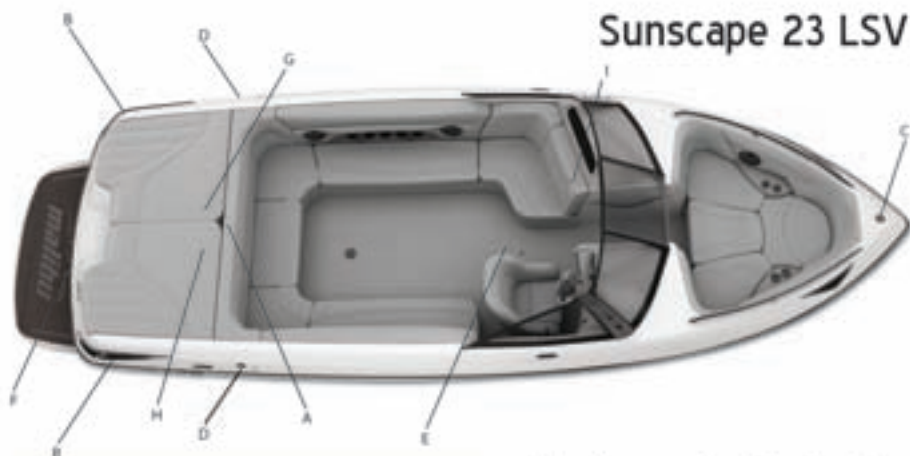

### Features & Controls

- |                            |                                       |
|----------------------------|---------------------------------------|
| A. Swivel Head Pylon       | F. Transom Grab Handle                |
| B. Rear Air Vent           | G. Sun Deck                           |
| C. Bow Light               | H. Locking Storage                    |
| D. Fuel Fill (2 locations) | I. Battery (in Observer Seat Storage) |
| E. Ski Locker              |                                       |

### Specifications

Length: 23' | Beam: 102" | Draft: 27" | Weight: 3800 lbs | Fuel Cap: 55 gal | Seating Cap: 14 | Std Engine: Monsoon 340 | Std Prop: ACME 13.5x17.5

## Sunscape 247 LSV

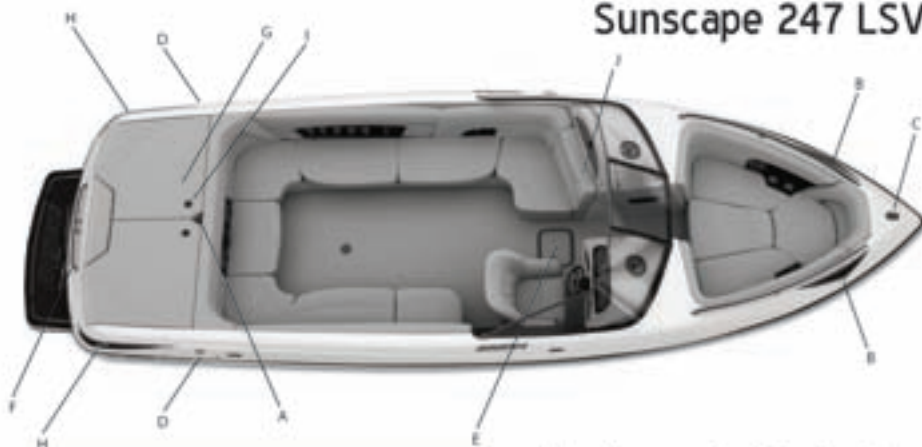

### Features & Controls

- |                            |                                       |
|----------------------------|---------------------------------------|
| A. Swivel Head Pylon       | F. Transom Grab Handle                |
| B. Air Intake Vent         | G. Sun Deck                           |
| C. Bow Light               | H. Rear Air Vent                      |
| D. Fuel Fill (2 locations) | I. Locking Storage                    |
| E. Ski Locker              | J. Battery (in Observer Seat Storage) |

### Specifications

Length: 24'7" | Beam: 102" | Draft: 27" | Weight: 3900 lbs | Fuel Cap: 87 gal | Seating Cap: 16 | Std Engine: Hammerhead 383 | Std Prop: ACME 13.5x17.5

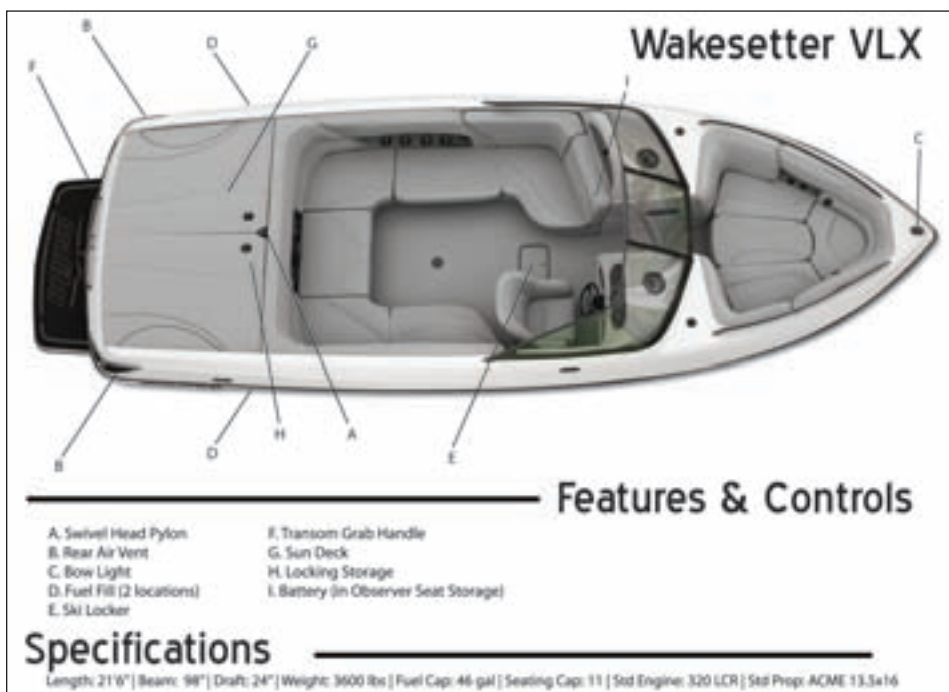
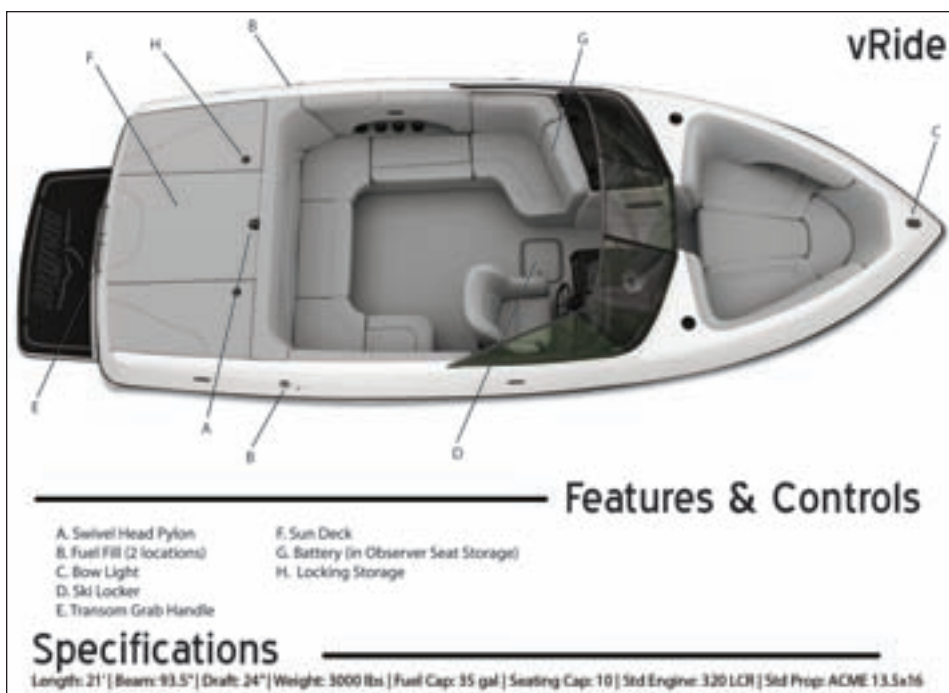

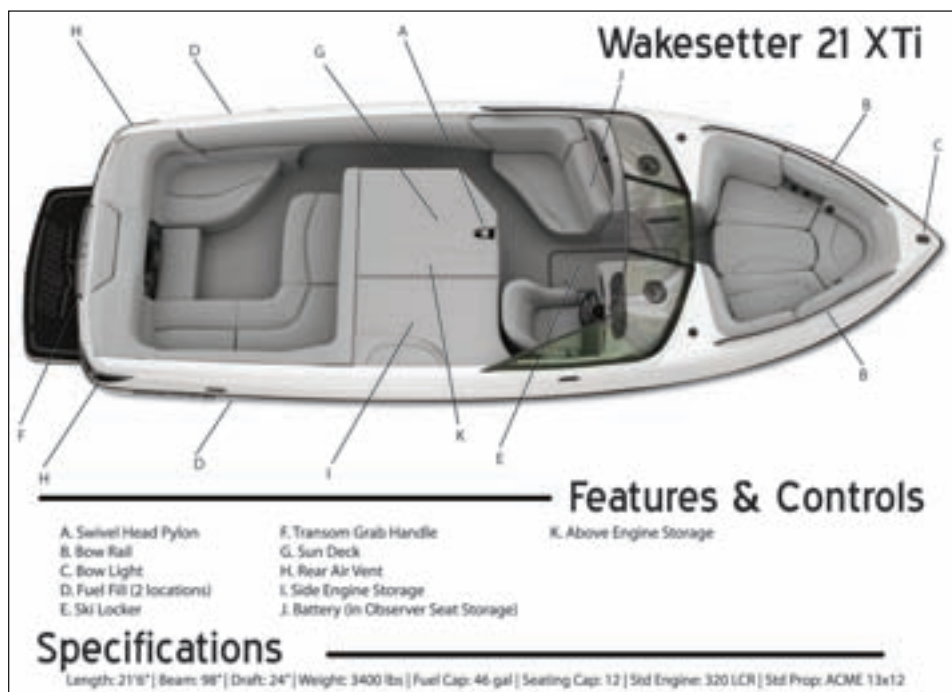
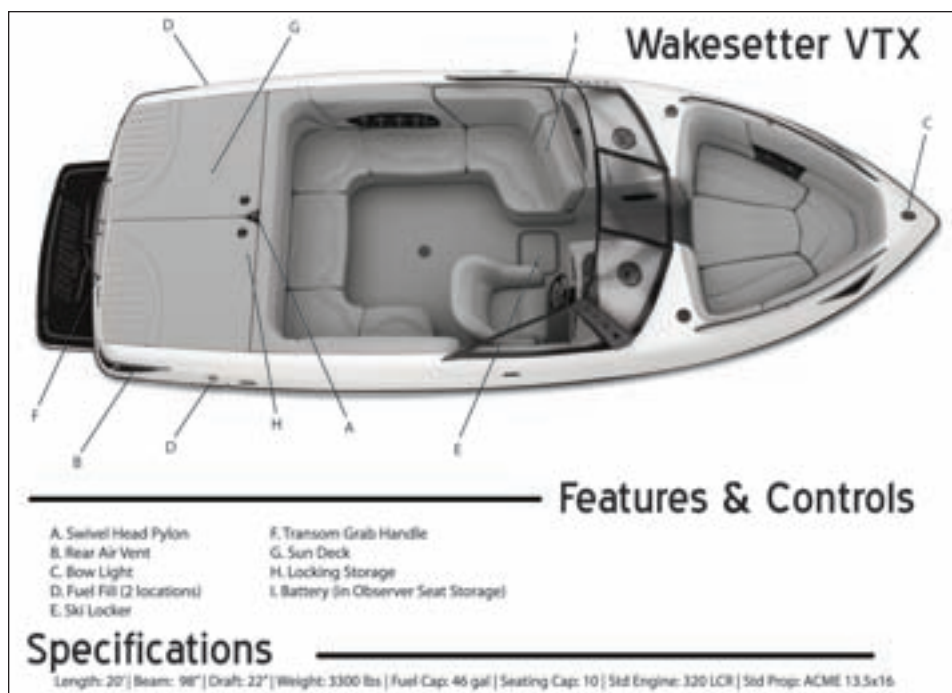

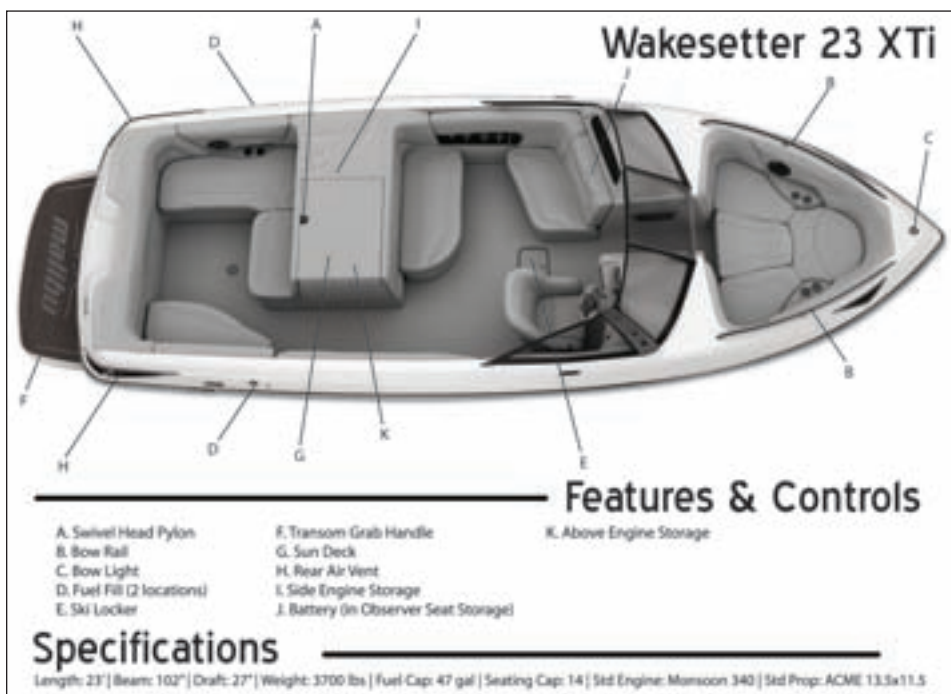
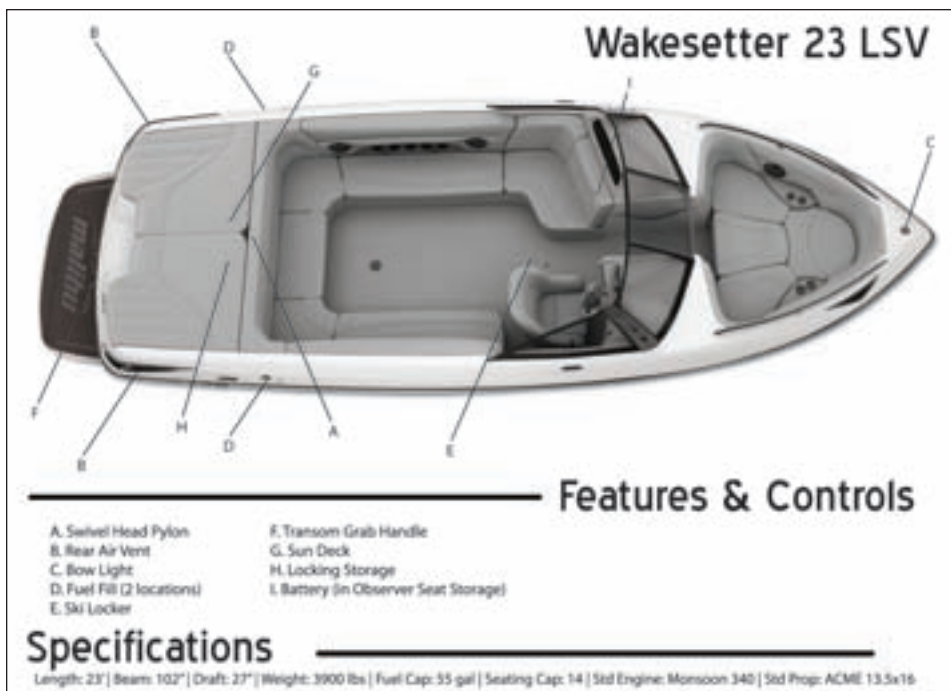

## Wakesetter 247 LSV

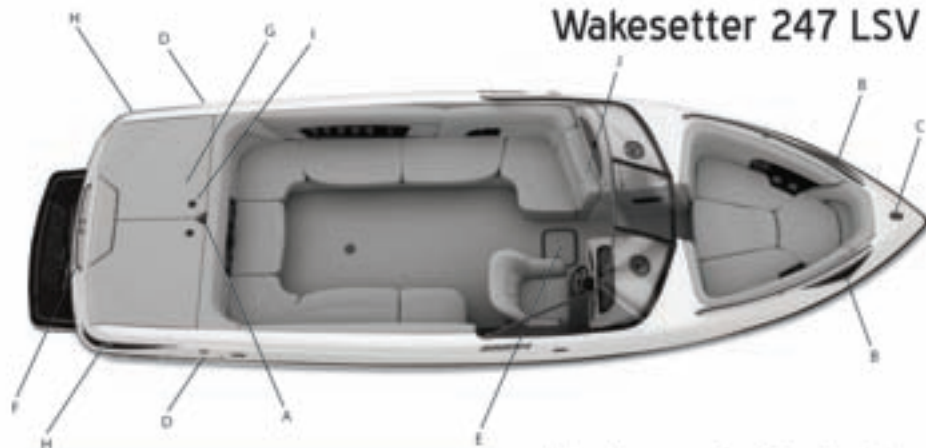

### Features & Controls

- |                            |                                       |
|----------------------------|---------------------------------------|
| A. Swivel Head Pylon       | F. Transom Grab Handle                |
| B. Air Intake Vent         | G. Sun Deck                           |
| C. Bow Light               | H. Rear Air Vent                      |
| D. Fuel Fill (2 locations) | I. Locking Storage                    |
| E. Ski Locker              | J. Battery (in Observer Seat Storage) |

### Specifications

Length: 24'7" | Beam: 10'2" | Draft: 2'7" | Weight: 4000 lbs | Fuel Cap: 87 gal | Seating Cap: 16 | Std Engine: Hammerhead 383 | Std Prop: ACME 13.5x16

## Wakesetter 247 RX

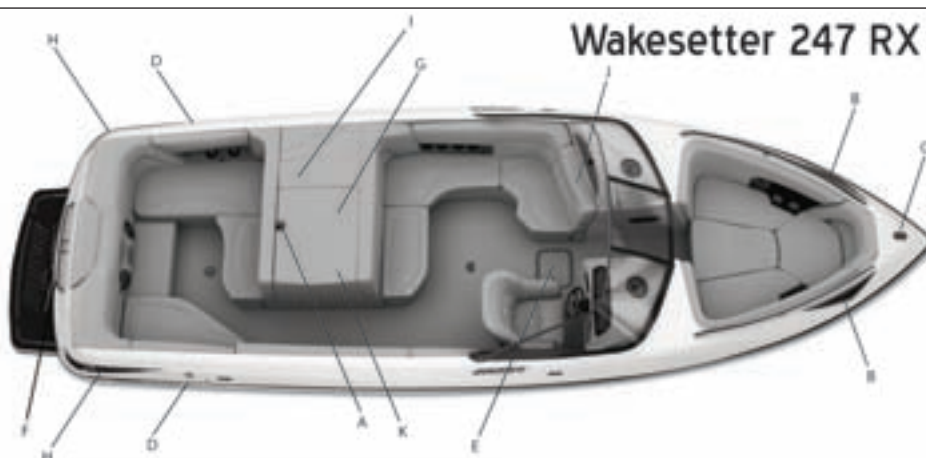

### Features & Controls

- |                            |                                       |                         |
|----------------------------|---------------------------------------|-------------------------|
| A. Swivel Head Pylon       | F. Transom Grab Handle                | K. Above Engine Storage |
| B. Air Intake Vent         | G. Sun Deck                           |                         |
| C. Bow Light               | H. Rear Air Vent                      |                         |
| D. Fuel Fill (2 locations) | I. Side Engine Storage                |                         |
| E. Ski Locker              | J. Battery (in Observer Seat Storage) |                         |

### Specifications

Length: 24'7" | Beam: 10'2" | Draft: 2'7" | Weight: 4000 lbs | Fuel Cap: 46 gal | Seating Cap: 16 | Std Engine: Hammerhead 383 | Std Prop: ACME 13.5x13.5



## Chapter 1

# BOATING SAFETY



*At Malibu, safety is not an option!*

## General Precautions

Your Malibu boat has been constructed to meet all U.S. Coast Guard and National Marine Manufacturers Association (N.M.M.A.) requirements. However, it is still your responsibility as the boat owner to ensure the boat is always operated in a safe fashion.

U.S. Coast Guard regulations require certain safety equipment be present on your boat during operation. Besides the U.S. Coast Guard regulations, other local and/or international law enforcement agencies may have similar requirements. You should check with your local marine enforcement agency regarding any such requirements before using the waterways.

It is not intended for this manual to be a replacement for a course on boating safety. It is highly recommended that if you are unfamiliar with the use and operation of a boat, you seek advice and training from a qualified individual or organization. Check with your local boating agency or Malibu dealer for more information about boating safety classes in your area.

## Safety Statements

Throughout this manual, specific precautions and symbols identify safety related information. Follow these precautions as indicated.



The Safety Alert symbol means Attention! Become Alert! Your Safety Is Involved!

### **DANGER**



*Indicates an imminently hazardous situation that, if not avoided, will result in death or serious injury.*

### **Warning**



*Indicates a potentially hazardous situation that, if not avoided, could result in death or serious injury.*

### **Caution**

*Indicates a potentially hazardous situation that, if not avoided, could result in minor or moderate injury or property damage. It may also be used to alert against unsafe practices.*

**Notice:** Indicates installation, operation or maintenance information which is important but not hazard related.

The precautions listed in this manual and on the boat are not all-inclusive. If a procedure or method is not specifically recommended, you must satisfy yourself that it is safe for you and your passengers, and that the boat will not be damaged or made unsafe as a result of your decision. **Remember — always use common sense when operating your boat!**

In an emergency situation, you may have to resort to measures which are not commonly practiced. Always assess the dangers of being in harm's way versus the protection of equipment. Keep a sound mind during an emergency and always think safety.

### **Teak/Drag Surfing**

READ, UNDERSTAND and be FAMILIAR with the information contained on any warning labels or any label on equipment and adhere to the boat operation practices described on them. The United States Coast Guard issued a SAFETY ALERT on August 28, 2001 that covers some of the issues of improper use of the boarding platform. The SAFETY ALERT and portions of the accompanying information follow:

Every year tragic deaths occur from the negligence of unsafe boating and dangerous activities. Experts say, "many of these deaths may have been caused by an invisible hazard, carbon monoxide poisoning." Taking the risk of swimming under a boarding platform when the engine is running, skiing within 20 ft (6.1 meters), "teak surfing" or "dragging" behind a moving boat can be fatal.

Any dangerous activities which can result in a serious injury or death a water sport is not considered as a watersport by Malibu or DOES NOT promote unsafe boating risks or jeopardizing any boaters safety.

DO NOT use the boarding platform for any other purpose than boarding the boat or preparation of entering the water, and DO NOT use the boarding platform when the engine is running.

### **SAFETY ALERT From August 28, 2001:**

The United States Coast Guard advised boaters not to "Teak/Drag Surf." Recent boating fatalities revealed that carbon monoxide (CO) emitted from a vessel's exhaust resulted in CO poisoning and the death of at least six teak surfers. "Teak/Drag Surfing" places the individual in position directly exposed to the CO in the engine's exhaust. This may result in a loss of coherent responses and even death. In addition, "Teak/Drag Surfing" dangerously exposes the individual to a possible propeller injury, and since it is done without a life jacket (PFD), it significantly increases the probability of drowning. Therefore, the Coast Guard stresses, "Teak/Drag Surfing" is a very dangerous activity and advises boaters not to participate in it.

The Coast Guard pointed out that carbon monoxide is one of the most dangerous gases. It strikes before you know you are exposed and it impairs in a way that can and too often does lead to death. That is why it is so important to the Coast Guard that in every circumstance where it can be avoided, it is.

---

## Regulations

The U.S. Coast Guard is the governing authority of the waterways and is there to help the boating public. State boating regulations are enforced by local authorities. You are subject to marine traffic laws and “Rules of the Road” for both federal and state waterways; you must stop if signaled to do so by enforcement officers and permit to be boarded, if asked.

## Responsibilities

### Registration

Federal Law requires that all motorboats be registered and that all motorcraft not documented by the U.S. Coast Guard display registration numbers. In nearly all states, this means registration with the designated state agency. In a few jurisdictions, the Coast Guard retains registration authority. Your Malibu dealer will either supply registration forms or tell you where they may be obtained. The agency will supply you with a certificate which must be carried with you when the boat is in operation.

### Education

If you have never owned a boat before, you can get an excellent introduction to boat handling from organizations such as the U.S. Coast Guard and American Red Cross. Even if you are a veteran boater, these courses will help sharpen your boating skills as well as bring you up to date on current rules and regulations. See your local boating agency or Malibu dealer for information on classes in your area.

### Insurance

The boat owner is legally responsible for damages or injuries he or she causes. Common sense dictates that you carry adequate personal liability and property damage insurance on your boat, just as you would on your automobile. You should also protect your investment from physical damage or theft.

### Restricted Areas

Before boating, check with Local, State and Federal authorities to identify restricted areas. Because of the threat of terrorism, the U.S. Coast Guard has and will continue to implement strict limits on watercraft near U.S. Navy and Coast Guard ships and other potential targets.

### Our Environment

As a boater, you already appreciate nature’s beauty and the peace of the great outdoors. It is a boater’s responsibility to protect the natural environment by keeping waterways clean. **DO NOT put anything in the water you would not want to eat or drink!**

### Conserve Fishery Resources

There is a tremendous drain on our fishery resources. Over-fishing and pollution have strained the fish population. Do your part by keeping only what you will eat by practicing catch-and-release.

---

## Foreign Species

If you trailer your boat from lake to lake, you may unknowingly introduce a foreign aquatic species from one lake to the next. Thoroughly clean the bottom of the boat, below the water line, remove all weeds and algae, and drain the bilge and livewells before launching the boat in a new body of water.

## Fuel and Oil Spillage

The spilling of fuel or oil into our waterways contaminates the environment and is dangerous to wildlife. Never discharge or dispose fuel or oil into the water; it is prohibited and you could be fined. There are two common, accidental types of discharge:

- Overfilling the fuel tank.
- Pumping contaminated bilge water.

## Warning



***Fumes from rags can collect in bilge and be extremely hazardous. Never store rags used to wipe-up fuel or solvent spills in the boat. Dispose of rags properly ashore.***

## Discharge and Disposal of Waste

Waste means all forms of garbage, plastics, recyclables, food, wood, detergents, sewerage and even fish parts in certain waters - in short, nearly everything. We recommend you bring back everything you take out with you for proper disposal ashore.

## Excessive Noise

Noise means engine noise, radio noise or even yelling. Many bodies of water have adopted noise limits. Music and loud conversation can carry a considerable distance on water, especially at night.

## Wake and Wash

Be alert for NO WAKE zones. You may be responsible for any damage or injury caused by your wake/wash. Prior to entering a NO WAKE zone, come off plane to the slowest steerable speed.

## Exhaust Emissions

Increased exhaust (hydrocarbon) emissions pollute our water and air. Keep your engine tuned and boat hull clean for peak performance. Consult your dealer and engine manual for information.

## Paints

If your boat is kept in water where marine growth is a problem, the use of anti-fouling paint may reduce the growth rate. Be aware of environmental regulations that may govern your paint choice. Contact your local boating authorities for information.

## Cleaning Agents

Household cleaners should be used sparingly and not discharged into waterways. Never mix cleaners and be sure to use plenty of ventilation in enclosed areas. **DO NOT** use products which contain phosphates, chlorine, solvents, non-biodegradable or petroleum based products. Citrus based cleaners are excellent for marine cleaning purposes and are safe for you and the environment. Refer to **CARE AND MAINTENANCE** for more information.

## Safety Equipment

U.S. Coast Guard regulations require certain accessory equipment on each boat. For a detailed description, obtain “Federal Requirements for Recreational Boats” published by the Coast Guard.

- 1) Personal Flotation Devices (PFDs): PFDs must be Coast Guard approved, in good and serviceable condition and the appropriate size for the user. It is recommended that you wear PFDs while your boat is underway.

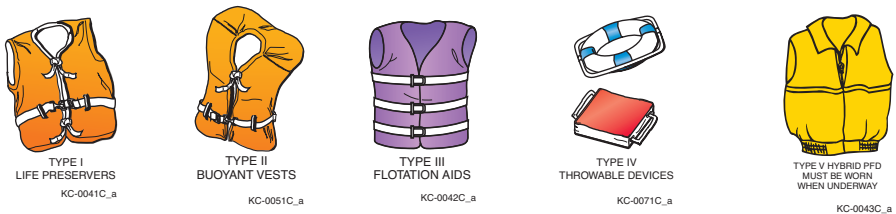

**Figure 1-1. Personal Flotation Devices**

Boats more than 16 feet in length must be equipped with one type I, II, III or V and one type IV. PFDs are intended to save lives; you and your passengers should wear them while in the boat. Learn how to use them and adjust as necessary to make comfortable to wear. The type II PFD is recommended for near shore or inland water use. Some PFDs are specially made for use while waterskiing and can handle impacts if a skier has fallen.

**Notice: If a type V PFD is to be counted toward the minimum carriage requirements, it must be worn**

- 2) Fire Extinguishers: A fire extinguisher is required if your boat has an inboard engine, or when fuel is stored in closed stowage compartments.

Approved fire extinguishers are classified by a letter symbol, either B-I or B-II with the B designating that the material will extinguish flammable liquids such as gasoline, oil, etc. B-I extinguishers are required for boats less than 26 feet in length. Check periodically to ensure that the extinguisher is in working condition and fully charged.

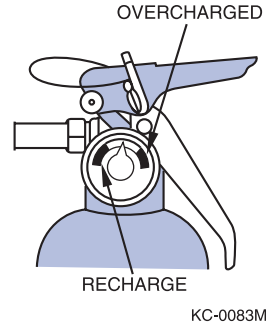

**Figure 1-2. Fire Extinguisher**

- 3) Navigation Lights: Recreational boats are required to display navigational lights between sunset and sunrise and other periods of reduced visibility (fog, rain, haze, etc.). Your navigation lights are provided to keep other boats informed of your presence and course. It is up to you to make sure they are operational and turned on when required.

## Emergencies

### Giving Assistance

Many of the distress calls are not true emergencies. In most cases, the boat is disabled for one reason or another, but there is no immediate danger of death or serious injury. However, emergencies can occur and you should know how to cope with them. If you observe a boat in distress, assume it is a true emergency. Proceed to the scene and render assistance. Federal law requires boat operators to offer assistance and aid to others. The law's "Good Samaritan" clause absolves you from any civil liability in the event that your assistance causes injury or property damage.

There is a way to handle nearly every emergency if you do not panic. Learn your boating lessons and safety procedures well, and you will have the confidence and ability to handle an emergency should one arise.

### Fires

Many boat fires involve flammable liquids such as gas or oil. Many inboard fires start in the bilge area which at times can be filled with gas vapors. Since gas vapors cannot be seen, boat fires tend to travel very fast. If you encounter a fire on board, turn off the engine immediately. If you have a fire extinguisher on board and access to the fire, it may be controllable. Direct the contents of the extinguisher at the base of the flames. Throw burning materials overboard if possible. Put on PFDs, if not already on, signal for help and prepare to abandon the boat if necessary.

## Reporting

Boat operators are required by law to file a Boating Accident report with their state boating law enforcement agency when their boat is involved in certain boating accidents. A boating accident must be reported if there is a loss or probable loss of life, personal injury requiring medical attention, damage exceeding \$500, or there is a complete loss of the boat. If any of these conditions arise, seek further assistance from local law enforcement personnel.

## Hazardous Conditions

Every waterway poses hazards that should be avoided. The following information outlines some of the hazards which may be encountered.

### Weather

Learn and understand weather patterns and signs of change. Bad weather can cause an uncomfortable and unsafe situation. If a storm approaches, seek a safe harbor.

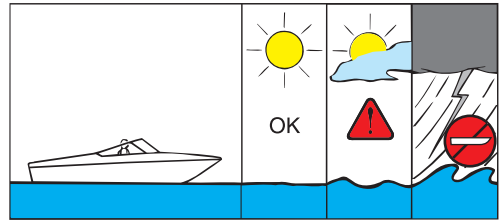

KC-0210M

Figure 1-3. Weather Hazards

### Dam Spillways

The area around dam spillways is very hazardous and conditions can change rapidly. Stay clear of the spillways and areas below dams.

### Weeds

Weeds can generally be a threat to a boat's engine and other components on the boat. If weeds wrap around the propeller, they can create vibration in the engine. They also restrict water intake, causing the engine to overheat.

### Shallow Water Operation

Shallow water brings on obvious hazards such as sand bars, stumps, rocks, etc. Know the area you will be operating the boat in. Hitting objects at high speeds can cause severe damage to people and the boat. If you know you will be navigating the boat in shallow water, post a lookout and proceed slowly.

Know the minimal depth your boat can safely travel.

**Caution** | *Damage to underwater gear caused by shallow water maneuvering is not covered by your warranty.*

### Warning Markers

Learn to recognize the different buoys and day markers; they are used as the signposts of the waterways identifying navigable routes and water hazards. It is a good idea to ask local authorities about hazard areas and if they are marked. Stay within boundaries and clear of hazards.



Figure 1-4. Diver Down Flag

Figure 1-8. Regulatory Markers



# Carbon Monoxide

Carbon Monoxide (CO) is a colorless and odorless gas produced by all engines and fuel burning appliances. Even with the best boat design and construction, plus the utmost care in inspection, operation and maintenance, hazardous levels of CO may still be present in accommodation spaces under certain conditions. To reduce CO accumulation, always ventilate the boat interior and avoid boating situations which cause increased exposure.

**DANGER** | ***EXTREME HAZARD – Carbon monoxide gas (CO) is colorless, odorless and extremely dangerous. All engines and fuel burning appliances produce CO as exhaust. Direct and prolonged exposure to CO will cause BRAIN DAMAGE or DEATH. Signs of exposure to CO include nausea, dizziness and drowsiness. Sources of CO include:***



**1** Blockage of boat exhausts by obstruction.

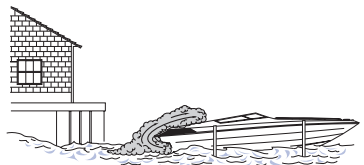

**4** Operating with high bow angle.



**2** Exhausts traveling along obstruction.

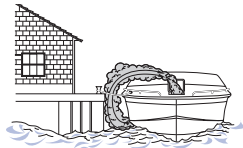

**5** Exhausts from other vessels in confined areas.



**3** Operating at slow speed or while dead in the water.

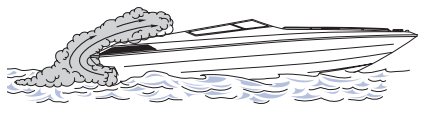

**6** Operating with canvas tops and side curtains in place without ventilation.



**ENSURE ADEQUATE VENTILATION FOR CORRECT AIR MOVEMENT THROUGH BOAT!**

KC-0461M



Figure 1-5. Carbon Monoxide Hazards

## Operation By Minors

If your boat will be operated by a minor, remember to have an adult present at all times. Many states have laws regarding minimum age and licensing requirements for minors. Contact state and local authorities for special requirements that may apply in your area.

## Passenger Safety

Any time you take your boat out, make sure that there is at least one other passenger aboard who is familiar with the operation of your boat. Passengers should be well aware of emergency equipment and shown how to use it. Passengers should also keep hands and feet in the boat and be safely seated while the boat is in motion.

Your boat should never be operated while you are under the influence of alcohol or drugs. Reaction times can be reduced and judgment affected creating situations that can be very dangerous.

### Warning



***Federal and state laws prohibit operating a boat under the influence of alcohol and other drugs. These regulations are actively enforced. Impaired operation may result in severe personal injury or death.***

## Basic Rules Of The Road

### Warning



***The nautical rules of the road must be followed to prevent collisions between vessels. Like traffic laws for automobiles, the operator is legally required to follow the rules.***

The following information outlines only the most basic of the nautical rules of the road. For more information, contact your local U.S. Coast Guard Auxiliary.

### Aids to Navigation

Learn to recognize the different buoys and day markers; they are the signposts of the waterways. The United States Aids to Navigation System (USATONS) is the primary marking system used on inland water, coastal waters and rivers. This system is maintained by the U.S. Coast Guard (USCG).

### Types of Buoys

There are several types and shapes of buoys. Buoys may be unlighted, lighted, with sound or may have both an audible and a visual signal. Lights, bells and horns are used on buoys for night or poor visibility conditions. Different shapes of buoys are shown below.

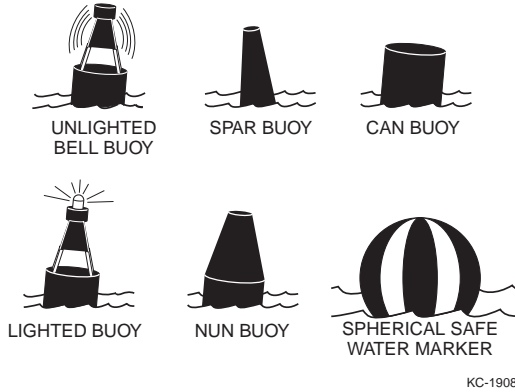

KC-1908

Figure 1-6. Types of Buoys

Buoys with unique light flashing characteristics are identified on nautical charts with the specific flashing pattern.

### Mooring Buoys

The only buoys you are permitted to moor to are mooring buoys. Mooring buoys are white with a blue horizontal stripe. Mooring to a navigation buoy, regulatory markers or lateral markers is illegal.



KC-1901

Figure 1-7. Mooring Buoys

### Regulatory Markers

Regulatory markers indicate dangerous or restricted controlled areas. These markers are used to indicate speed zones, areas set aside for particular use, general information and directions.

Regulatory markers are white with orange geometric shapes and also have orange bands near the top and at the water line of the buoy. You must obey regulatory markers.

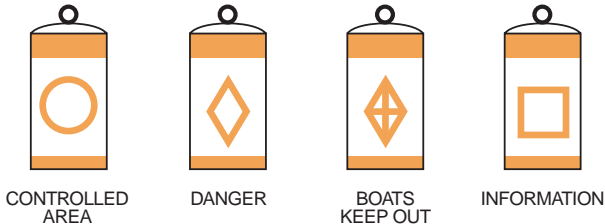

KC-1903

Figure 1-8. Regulatory Markers

## Right-Of-Way

**Notice:** In general, boats with less maneuverability have right-of-way over more agile craft. You must stay clear of the vessel with right-of-way and pass to his stern.

### Privileged Boats

Privileged boats have right-of-way and can hold course and speed. Sailboats and boats paddled or rowed have the right-of-way over motor boats. Sailboats under power are considered motorboats. Small pleasure craft must yield to large commercial boats in narrow channels.

### Burdened Boats

The burdened boat is the boat that must make whatever adjustments to course and speed necessary to keep out of the way of the privileged boat.

### Crossing Situation

In crossing situations, the boat to the right from the 12 o'clock to the 4 o'clock position has the right-of-way. It must hold course and speed. The burdened boat keeps passes behind the privileged boat. Boats going up and down a river have the privilege over boats crossing the river.

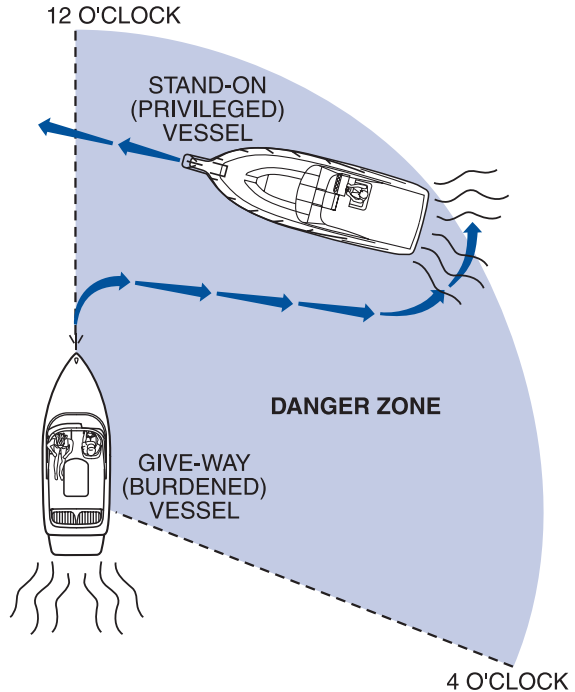

Figure 1-9. Crossing Situation

KCB-002

### Meeting Head-On

Neither boat has the right-of-way in this situation. Both boats should decrease speed, should turn to the right and pass port-to-port. However, if both boats are on the left side of a channel, each vessel should sound two short horn blasts and pass starboard to starboard.

## Overtaking

The boat that is overtaking one ahead of it is the burdened boat and must make any adjustments necessary to keep out of the way of the privileged boat.

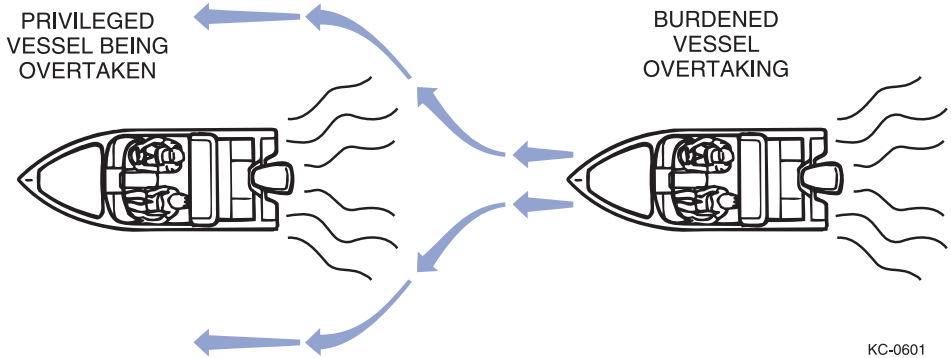

Figure 1-10. Overtaking Another Craft

## The General Prudential Rule

The general prudential rule regarding right-of-way is that if a collision appears unavoidable, neither boat has right-of-way. As prescribed in the Rules of the Road, both boats must act to avoid collision.

## Night Running

Boats operating between sunset and sunrise (hours vary by state) must use navigational lights. Nighttime operation, especially during bad weather or fog can be dangerous. All Rules of Road apply at night, but it is best to slow down and stay clear of all boats, regardless of who has right-of-way. Protect your night vision by avoiding bright lights and have a passenger, if possible, help keep watch for other boats, water hazards and aids to navigation.



## Chapter 2

# GAUGES & CONTROLS



*No other ski boat manufacturer incorporates in their product as many innovative and technically advanced features as Malibu.*

### Standard Gauges

The following gauges are included on all models. It is important for the safe and proper operation of your boat to fully understand these gauges.

#### Malibu In-Dash Graphical Display



**Figure 2-1. Graphical Display**

Malibu's state-of-the-art Malibu Graphical In-Dash Display Center enables the operator to observe and control many graphic functions that are applicable to the performance and use of your boat. These include Malibu Cruise Control, Ballast Monitoring System (BMS), Air/Sea Temperature, Depth, as well as standard use gauges for monitoring service requirements, voltage, engine temperature, oil pressure, remaining fuel level and percentage, speedometer and tachometer.

### Tachometer

Located to the left side of the dash panel, the tachometer registers the operating speed of your engine in revolutions per minute (RPM). This gauge is used to provide you with information needed to ensure the engine is kept within the engine manufacturer's recommended proper range of operation. For your additional benefit, there are other RPM monitoring capabilities available in your dash system that will be explained later in this manual. Also included in the gauge panel are additional digital readings for oil, volt and hour meter. The system defaults to these readings from the display panel and no adjustments are possible. Be sure to consult your engine manual for the correct range of operation for your particular engine model.



Figure 2-2. Tachometer with Oil, Volt Hourmeter

### Caution

***Do not operate your boat beyond the recommended RPM range. This could cause irreversible problems, and may not be covered under your engine warranty.***

### Speedometer

The Speedometer registers speed in miles per hour (MPH). The speedometer system consists of a thru-hull paddle wheel speed sensor that records water movement which sends information to a computer located under the dash. The speedometer readings can also be found in the digital display window of the In-Dash graphical display located in the center of the gauge panel. Additional information will be explained later in this manual for this display. The speedometer is calibrated from the factory and does not normally require adjustment. However, from time to time it may be necessary to recalibrate. To calibrate the speedometer, see *Speedometer Calibration* in this manual. Also included in the speedometer gauge panel are additional digital readings for depth, air and lake temperatures. The system defaults to these readings from the display panel and no adjustments are possible.



Figure 2-3. Speedometer with Depth, Air and Lake Temperature Gauge





Figure 2-4. Dash Gauges

### Engine Temperature

The temperature gauge is located at the lower center left bottom panel of the dash display. The temperature gauge indicates the temperature of the water/coolant inside the engine. The proper operating range for your engine is between 140 – 160° F. All engines are equipped with an engine control module that will cause the engine to run at reduced speeds (power reduction mode) if the engine is running above recommended operation temperatures. If you notice that your speed has reduced during normal running operation without reducing the throttle, monitor your temperature gauge. If your temperature gauge indicates excessive temperatures, slow down immediately and turn off engine. Continuing to operate the boat while the temperature is above normal operating parameters may cause serious damage to your engine.

### Oil Pressure

The oil pressure gauge is located at the lower center of the bottom panel of the dash display. The oil pressure gauge indicates the oil pressure in the engine while the engine is running and is measured in pounds per square inch (psi). Oil pressure may vary with engine speed, outside temperatures, oil viscosity and other environmental factors. If the oil pressure reading is below the normal range, you should stop your engine and check your oil immediately.

Average pressure ranges are between 6 psi at 1000 RPM and 80 psi at cruising speeds. If you are experiencing low oil pressure, stop your engine and check your oil before operating again.

### Warning



***Do not continue to run engine if pressure is low. If you do the engine can become so hot that the surrounding components could catch fire.***

**Notice:** Damage caused from neglected oil problems can be costly. Such damage is not covered by your warranty.

## Fuel

The fuel gauge is located at the lower center right bottom panel of the dash display. The fuel gauge indicates the approximate quantity of fuel remaining in the tank when the ignition is in the “On” position. Although your fuel tank will still have some fuel remaining even though the gauge reads empty, it is recommended that the tank be filled when the gauges indicates 1/4 full.

**Warning** | *Do not top off tank.*



**Notice:** It is not uncommon during operation of your boat for the fuel gauge to register slightly different amounts than what is actually in the tank. This is normal operation and does not indicate a problem. The fuel gauge will read most accurate when sitting still in calm water.

## Malibu Graphical In-Dash Display

All 2008 boats will include the Malibu Graphical In-Dash Display as a standard feature. This display can be found in the center of your dash console behind the steering wheel. Information is displayed in digital format for easy to read information, navigable using the Function up ↑ arrow, or Function down ↓ arrow followed by pressing the Enter (E) button in the center right of the display panel. The Graphical Display includes these features: Malibu Cruise, Ballast Monitoring System (BMS) “Available in wakeboard models only,” Air/Sea Temp, Depth meter, Power Wedge and service.



Figure 2-5. In-Dash Display

### Setup

When you first turn on the ignition of your boat, you will see the screen above, followed by a Setup menu. To navigate the system menus, use the up/down  $\uparrow \downarrow$  arrows. When you arrive to the screen you would like to use or setup, press the E (Enter) on the display panel. To exit the setup menu, press the red button; this will return you to your default screen.

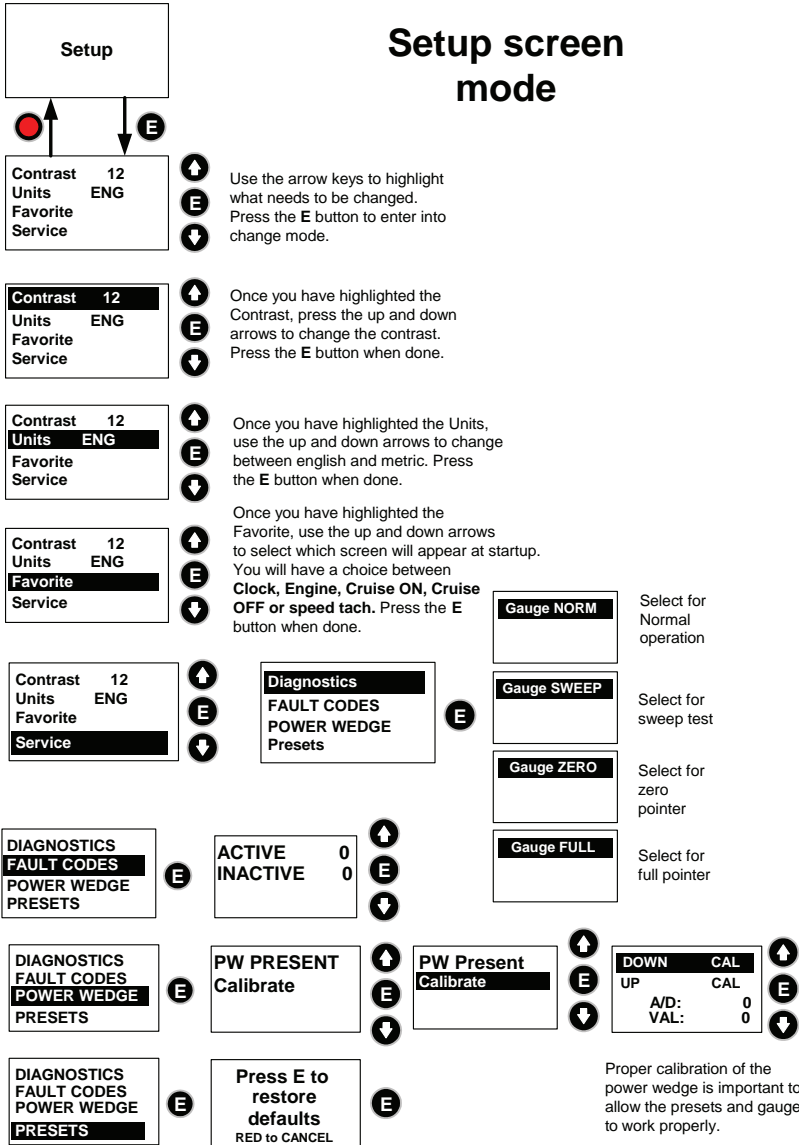

To exit the **SETUP** screens press the red button.

# MALIBU PRESETS

Press the **CRUISE** button to enter the standard cruise screen.

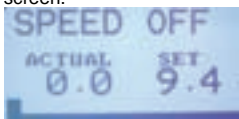

Press the **CRUISE** button a second time to enter the **PRESET** screen. Use the **UP** and **DOWN** buttons to highlight the preset you wish to engage or edit. Press the **RED** button to activate the preset or press the **E** button to edit the preset.

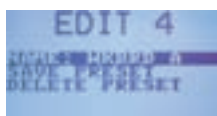

Use **E** button to edit the name, save the preset, or delete the preset. Saving a preset will lock in the current speed, ballast levels, the wedge location and the edited name.

Pressing the **RED** button will bring you to the PRESET information screen (sample below). This screen will tell you everything that the selected preset is doing to prepare the boat such as filling the tanks, moving the wedge and setting the speed. This screen will be displayed until all the tasks have been completed, or until the cruise button is pressed or the cruise speed has been reached.

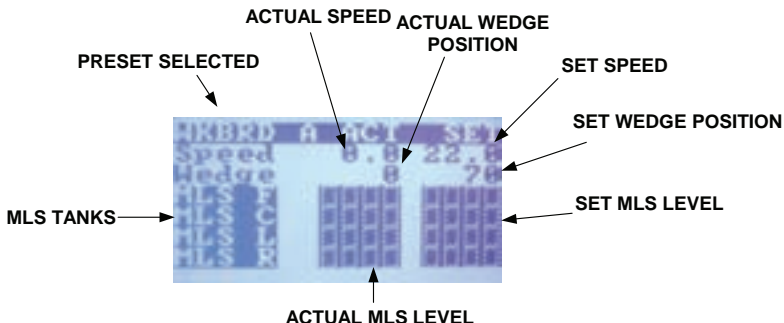

The cruise speed screen will show the normal information along with the preset that has been selected. You can reset the presets to factory defaults in the setup screen.

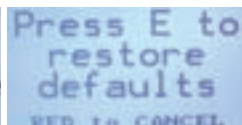
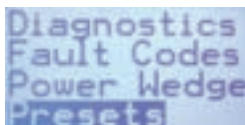

---

## Boat Alarms and Engine Faults

Malibu Boats are equipped with two separate computers connected to many sensors and controllers that constantly monitor various functions of the boat and engine. Certain functions, if outside of a pre-determined operational parameters, may activate an alarm. When an alarm is activated, you will hear an audible buzzer alarm and see an alarm indicator in the Multi-Function LCD display. Both the engine's Electronic Control Module (ECM) and the dash Medallion Instrumentation Computer (M3) have the ability to activate an alarm.

If the Medallion Instrumentation Computer (M3) activates the alarm, you will see exactly what the fault description is in the display; such as low oil pressure, high coolant temp, low or high system voltage Depth alarm and Power Wedge over-speed. The M3 monitors these sensors independently of the ECM via the CAN link. Additional alarm parameters may be added.

The Indmar engine for 2008 is equipped with the latest GM / Delphi MEFI-5A Engine control Module with OBD-M. If the engine ECM activates an alarm you will either see "Engine Fault" or "Service Required". "Service Required" will only be seen on 2007-2008 Monsoon engines equipped with Catalysts Emissions System for the CARB (California Air Resources Board) and EPA requirements as of June 30, 2006.

**The "Engine Fault" alarm:** Is activated by the ECM. The problem could be a momentary out of parameter minor issue **or the problem could be catastrophic**. If the 'Engine Fault' alarm is activated, look at the gauges, oil P, temp and volts, and then shut down the engine, Key off, then restart. If the problem was a minor momentary, out-of-parameter fault, the fault should reset during the key cycle. If the problem is more serious, the alarm will be reactivated after restart. If the alarm continues, you should discontinue use until the problem is diagnosed and fixed.

On the 2008 Medallion Instrumentation system we have added OBD-M. OBD-M gives you the ability to read the Fault Codes out of the ECM using the Multi Function LCD Display. OBD-M is intended mainly for EFI Technicians to use, but would be beneficial to have it available for our customers to use if the need arises. You can at least call your dealer or Malibu and tell them what you see on the OBD-M screen.

**To Enter the On-board-Diagnostics- Marine Tool**, you will need to scroll the "UP" or "DOWN" button to the "Service" screen. Once in the service screen, press "E (Enter)." Then use the "UP" or "DOWN" arrows to highlight "Fault Codes". At this point you will need to pay close attention; you will now see two lists: **Active 1** or **Inactive 1**. It is the 1 or 0 that is important here. If the fault is currently **Active** (a real serious problem), you will see a 1 to the right of active. If the problem was a momentary out of parameter issue, you will see a "0" next to Active and you will see a "1" to the right of Inactive. Inactive is much better then Active. Inactive means the problem is gone or has fixed itself during the reset.

If the fault Code is Active, you will want to press the "E (Enter)" button with "Active 1" highlighted in the screen. At this point you will read the Service Parameter Descriptions and DTC's in its OBD-M format. Again, this tool is not intended for everyone, yet again,

---

it may tell you: “knock system no response” if you take a look and find the knock sensor unplugged, you save the day and a trip to the dealer! If you are unable to resolve the active code and the alarm continues and you have good oil pressure and engine temperature, as soon as possible, take the boat back to the dealer.

**Service Required Alarm:** The Monsoon Engine equipped with Catalyst Emissions system is the only engine you could see “Service Required” on. Service Required parameters are all based on “emissions related faults”. Several of the typical sensors are now part of the emissions related faults, such as the Knock system and Ignition Control system as well as the oxygen sensors and Catalyst Monitoring system. Be advised: Per EPA and CARB requirements, any emissions related fault, even if it is no longer active, will not reset and clear the alarm until the engine has completed three complete warm up cycles from 90° to 150° F. You have the ability to use the OBD-M tool in emissions related faults also.

**Turn Off the Alarm!:** By turning off the alarm you are acknowledging that you know there is a problem on your boat! Press the “E (Enter)” button to disable the alarm for five minutes. The alarm will reactivate in five minutes

### **Clock/Hour Display**

Press the E to display the setup screen “Clock/Hour Display.” The month, day and year will be displayed. Set month first, press enter “E (Enter)” to move to the next selection; set the day, press “E (Enter)”, then day “E (Enter)”. Once the year is set, the selection will continue to set the time. Set each completed: hour, minute second; to move to the next screen, press “E (Enter)” up ↑ arrow. The next display panel will be shown.

### **Temperature**

The air and water temperatures are shown on the display panel. Temperature can be displayed in either Fahrenheit or Celsius. See English/Metric operation in the SETUP menu to change view.

### **Depth**

The depth meter will display lake depth, and can be set for shallow water alarm. To set the shallow water settings, press the “E (Enter)” on the display panel. The display will be flashing. Scroll through the settings until the desired water depth is set. The system is set to default at 2 ft. Once this is completed, press “E (Enter)” to return to main menu.

### **MPH/RPM**

Your dash display can also be set to display boat running speeds and RPM. If your speedometer needs correction due to changes in the system, it can be done using the MPH mode screen (see Speed Calibration).

### **Speed Calibration**

The speed can be calibrated manually when the boat speed is between 15 and 36 MPH. To calibrate, scroll through the display menu to MPH/RPM. Press and hold “E (Enter)” to enter. Highlight MPH and use arrow buttons to adjust speed UP or DOWN. Press “E (Enter)” to exit. The MPH mode is all that can be recalibrated.

### Malibu Cruise Control (Standard on all Boats)

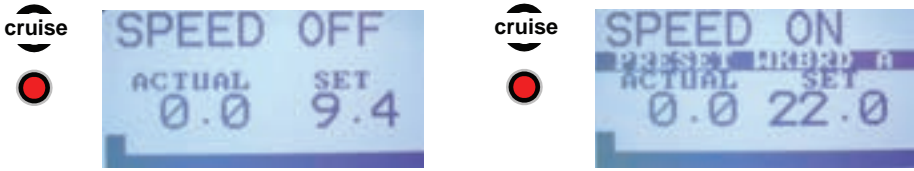
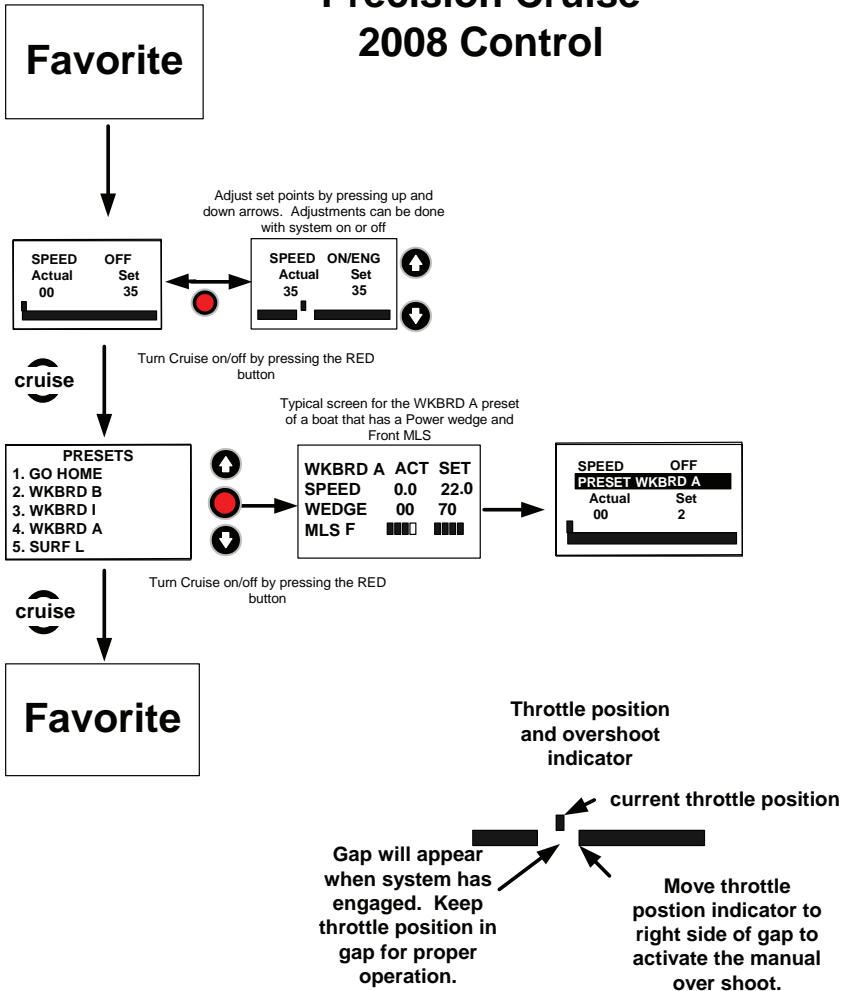

Figure 2-6. Cruise Control

### Malibu Precision Pro Speed Control

## Operation of Precision Cruise 2008 Control



In the upper port corner of the display menu is the CRUISE button. To activate, turn the engine on. While in NEUTRAL, press the cruise button on your display to get the system into speed control mode. Press the red button to turn the speed control ON. Adjust the target speed on the display if necessary with the “UP ↑” and “DOWN ↓” arrows to set your rider’s desired speed. The system’s cruise will take over when the boat speed has reached the target speed. When boat speed gets closer to the target speed, you will notice the speed control system take control of engine speed and the display will change from “ON” to “ENG” (Engaged). An audible alarm will acknowledge engagement and a window will pop up in the solid bar at the bottom of the display. This window at the bottom of the display is your throttle target window. The small square above the target window is your actual throttle position.

To provide the system with the tolerance needed to maintain steady speed, adjust your throttle to position the small square in the center of the target window.

When the small square is centered in the target window, the Precision Pro Speed Control System will hold the desired target speed. If the small square is to one side of the target window, the computers will have limited authority to adjust the throttle. If throttle adjustment is needed to hold the target speed, the window will close and display “more throttle”, apply more throttle to adjust.

To disengage:

Simply pull back on the throttle. If you advance the throttle, the system will re-engage at the target speed. To turn the system off:

Press the red button in the display or turn the ignition key OFF.

With the system ON, you will be limited to the target speed.

If you forget to turn the system on before you pulled the rider up, you can push the red button to turn the system ON, however you will need to reduce the boat speed to at least 6 MPH below the target speed and then back up, to get the system to engage.

To exit the CRUISE display and return to the default screen, press CRUISE twice.



## Ballast Monitoring System (BMS) (Standard on Wakesetter Model)



Figure 2-7. BMS

All Wakesetter models come standard with the Ballast Monitoring System (BMS) display. The BMS can be used to visually see the amount of water ballast that is in each tank. The ballast amount is monitored in 1/4 tank increments, and can monitor the center, left and right rear tanks and optional front bow tank. The ballast fill switches are located on the dash switch panel labeled MLS. To activate the BMS, press the BALLAST button on the Dash Display. The BALLAST display window will show. To exit the BALLAST display screen, press the Red button; this defaults to your Favorites Screen.

Boats that are not equipped with the ballast monitoring system will not have the ballast option on the display. It will be replaced with the Speedo option. This is used as a shortcut to the speedometer calibration screen.

## Power Wedge

The Power Wedge (PW) is an adjustable wake enlargement device designed specifically for wakeboarding. It is not intended to be used over 25 MPH. The PW alarm will activate if the foil is not in the “stowed” or “all the way up” position and the boat speed exceeds 25 MPH. You must slow down to between 1 and 10 MPH to raise the foil all the way up. The Power Wedge is intended to be deployed “down” prior to pulling up the rider, it will not deploy above 10 MPH.

Boats not equipped with PW must have the Power Wedge mode switched to N/A instead of PRESENT.

The Power Wedge is a computer controlled intelligent device. The computer determines if the boat speed is safe to operate the PW. If the boat speed and foil position are within the safe operational parameters, the computer will allow you to adjust the foil. If the boat speed and foil position are out of the safe parameters, the Power Wedge will not operate.

The Power Wedge Foil will deploy from the fully up or “stowed” position to the fully down or “operating position” as long as the boat speed is under 10 MPH. It will deploy “down” sitting on the trailer if the key is ON and the switch is depressed on the “DOWN” arrow. It will not deploy “up” unless the boat speed is between 1 and 10 MPH. Once the foil is all the way down, you will have the ability to adjust the size and shape of your

wake when the boat speed is between 10 and 25 MPH. The driver should always begin the towing session with the foil in the down position. Once the boat is at the desired wakeboarding speed, the driver can increase the wake size by pressing the “UP” arrow on the PW switch in momentary increments or decrease the wake size by pressing the “DOWN” arrow in momentary increments. The driver can monitor the Power Wedge gauge for reference to the adjustments. When the boat speed is between 10 and 25 MPH, the foil will not raise above the predetermined operating limit which is the largest, sharpest, usable wake in which the foil can create. With the foil in the lowest position, the wake is comparable to approximately 400 lb of ballast in the rear of the boat.

Your Malibu can be trailered or launched with the PW down, but make sure to raise it once you are on the water. DO NOT operate the PW with people on the swim step or near the PW.

**Notice:** Be sure the wedge unit is up before loading boat on trailer.

**Warning**



***Ensure all passengers are in the boat before changing wedge position. Stay clear of wedge unit while in motion. Fingers and clothing can be pinched between wedge arms and bracket, causing serious injury to passengers.***



Figure 2-8. Power Wedge

## Circuit Breakers

All major boat circuits are protected from shorting and overload by resettable circuit breakers. If a problem develops with one of the following circuits, switch off the circuit and wait about one minute. Then push the appropriate breaker button fully and switch on the circuit. If the circuit continues to trip, there is a problem somewhere in the system. See your dealership immediately to locate the problem.



Figure 2-9. Circuit Breaker Panels

## Switches & Indicators

### Accessory Switch Panels

These panels are located in the dash directly below the standard gauges and are used to activate the following features. You will find the feature or accessory provided within each button face for description.

- Horn
- Navigation Lights
- Interior Lights
- Accessory Docking Lights
- Accessory Tower Lights
- Accessory Shower
- Accessory Heater
- Accessory Malibu Launch System (MLS)
- Accessory Stereo
- Bilge Pump
- Blower

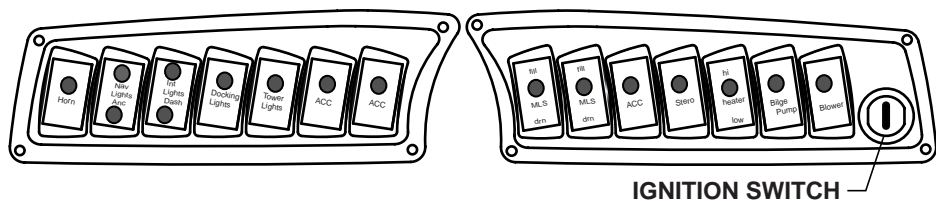

mal-06-015

**Figure 2-10. Accessory Switch Panel**

### Bilge Pump

The bilge pump switch is used to activate the bilge pump so that any excess water in the bilge area may be drained out. You should know that the bilge pump has a sensor in the bilge area and will turn on automatically whenever 2 in. or more of water is detected.

### Blower

This switch activates the blower for the engine compartment. The primary function of the blower is to eliminate any fumes in the motor compartment when starting the engine or during idling.

### Warning



***Gasoline Vapors Can Explode. Before starting engine, operate blower for 4 minutes and check engine compartment for gasoline leaks or vapors. Run Blower below cruising speed.***

### Stereo Power

The optional stereo system can be activated by either turning the ignition key on after starting your boat, or can be used without the engine started by turning the key to the left position; the stereo head unit is located under driver seat armrest. See Stereo control section for specific system use.

### Accessory #1

This switch is used to supply power to the optional heater unit. (For information on the use of the heater, please see heater operation in the optional equipment section of this manual.)

### Accessory #2

This switch is used to supply power to the optional hot water shower. (For information on the use of the hot water shower, please see hot water shower usage in the optional equipment section of this manual.)

### Interior Lights

This switch is used to activate the interior lights. The interior lights include lights in the gunnels, storage compartments and dashboard.

## **Navigational Lights**

In the ANC (anchor) position, this switch is used to activate the stern light. Keep the stern light on after dusk whenever your boat is at rest in the open waterway. While underway, place the switch in the RUN position to also activate the red and green navigation bow lights.

## **MUX Switch**

The 2008 Malibu system comes with three different MUX switch modules: one on the left that has the HORN button; one on the right that has the STEREO buttons; and an optional one for the back that has the STEREO buttons.

These modules have the ability to have any function added, subtracted or moved. This makes the boat a lot more flexible when adding or deleting options from the switches.

The MUX switches are connected to the boat and POWER module by the CAN BUS. If CAN communication is lost between it and the POWER module, the MUX will display last known output state.

The MUX switch indicates the current status of each switch, so that if the MINI activates one of the ballast fill pumps, the MUX switch will show FILL on that tank.

The MUX is designed to stay active for 30 minutes after ignition is off and all switches are off.

The MUX switch will wake up anytime a button is pressed with ignition off.

The Vertical button is called the PAGE button. It allows the user to toggle through the menu to buttons on other pages.

---



**Figure 2-11. MUX Switch**

BIDGE PUMP ON	Pressing the BIDGE button will toggle the POWER module output and MUX display from OFF to ON and back to OFF again.
DASH LIGHTS DIM1	Pressing the DASH LIGHTS button will toggle the POWER module output and MUX display from OFF to ON to DIM 1 to DIM2 and back to OFF again. DIM 1 and 2 are two lower levels of brightness for the dash.
INTERIOR LIGHTS OFF	Pressing the INTERIOR LIGHTS button will toggle the POWER module output and MUX display from OFF to ON to DIM 1 to DIM2 and back to OFF again. DIM 1 and 2 are two lower levels of brightness for the boat.
BLOWER ON	Pressing the BLOWER button will toggle the POWER module output and MUX display from OFF to ON and back to OFF again.
NAV/ANC LIGHTS ON	Pressing the NAV/ANC LIGHTS button will toggle the POWER module output and MUX display from OFF to NAV/ANC ON to NAV ON and back to OFF
HEATER LOW	Pressing the HEATER button will toggle the POWER module output and MUX display from OFF to HIGH to LOW and back to OFF again.
MLS LEFT OFF	Pressing the MLS LEFT button will toggle the POWER module output and MUX display from OFF to FILL to OFF to DRAIN and back to OFF again.
MLS RIGHT FILL	Pressing the MLS RIGHT button will toggle the POWER module output and MUX display from OFF to FILL to OFF to DRAIN and back to OFF again.
MLS CENTER FILL	Pressing the MLS CENTER button will toggle the POWER module output and MUX display from OFF to FILL to OFF to DRAIN and back to OFF again.
MLS FRONT DRAIN	Pressing the MLS FRONT button will toggle the POWER module output and MUX display from OFF to FILL to OFF to DRAIN and back to OFF again.
TOWER LIGHTS OFF	Pressing the TOWER LIGHTS button will toggle the MINI MMDC module output and MUX display from OFF to FRONT to ALL and back to OFF again.
DOCKING LIGHTS ON	Pressing the DOCKING LIGHTS button will toggle the POWER module output and MUX display from OFF to ON and back to OFF again.
POWER WEDGE DEPLOY DEPLOY	Pressing the POWER WEDGE DEPLOY button will toggle the MINI to move the WEDGE to its down position. This is done automatically once the button is pressed. The POWER module will turn off after it has reached the bottom or 10 seconds has elapsed.
POWER WEDGE DOWN DOWN	Pressing the POWER WEDGE DOWN button will toggle the POWER module output to supply power to the WEDGE to move it down. The WEDGE will move down as long as this button is pressed.
POWER WEDGE UP UP	Pressing the POWER WEDGE UP button will toggle the POWER module output to supply power to the WEDGE to move it up. The WEDGE will move up as long as this button is pressed and the boat is moving faster than .3 mph.

## Throttle Control

The throttle lever is located to the right of the driver. When the throttle is vertical, it is in the “NEUTRAL” position. At the base of the throttle you will find the shift lock. Pulling outward on this button disengages the transmission, thereby allowing use of the throttle without engaging the transmission. This is needed for starting or warm-up of the engine. Be sure to position the throttle vertically (in “NEUTRAL”), before re-engaging the transmission, by depressing the button.

When engaging the transmission from “NEUTRAL” to either forward or reverse, you must pull up on the safety collar located directly below the throttle lever knob.

### Warning



***Before starting engine or engaging transmission, ensure all swimmers are out of the water.***

### Electronic Throttle Control-ETC

All 2006-2008 Malibu Boats are equipped with electronic throttle control AKA “Fly-By-Wire”. The throttle cable has been removed and several components on the engine and helm throttle control have been changed. The helm throttle control “E-MV3” is now dual, variable voltage potentiometer that sends electronic signals back to the engine ECM via a shielded wire harness with the highest quality GM/Delphi water-tight connectors that mates to the engine ECM. The ECM then uses the signals from the E-MV3 to precisely control the engine speed with an electronic throttle body.

All 2008 Malibu Boats with Indmar Engines are fitted with GM/Delphi MEFI-5A Engine Control Module that offers fully sequential fuel injection and high speed CAN communication link which supports both OBD-M (On Board Diagnostics-Marine) advanced engine diagnostics and onboard system networking, plus the latest developments in electronic throttle control technology.

**ETC failure:** If for any reason, any part of the electronic throttle control system fails; (unplugged, wire cut, short, loss of power, sensor failure) the engine controller will default to “Idle”. You will have “no” control of the throttle, the “Engine Fault” alarm will also be activated. If this ever happens; turn the key OFF and then restart. This will reset the computer area network. If this condition continues, take the boat to the dealer.

**8.1 Engines:** Boats equipped with the 8.1 L engine, when reducing speed from above 2500 RPM to coast to a stop, you will want to leave the boat in gear until the RPM drops below 2500 RPM. If you pull the throttle into neutral, you may experience RPM flair. This is caused by reducing the load on the engine at high RPM.



**Figure 2-12. Throttles**

For more information regarding the safe operation and maintenance of the throttle control, refer to the separate instructions located in the information packet shipped with your boat.

## Steering System

It is important that you get the “feel” of your Malibu boat’s steering system. Turn the wheel from full left to full right, and make sure the rudder is turning accordingly. The system should operate freely and smoothly.

**Notice:** It is normal for your Malibu steering to pull slightly to the right under normal driving conditions. The boat will pull straight while skier is under tow.

## Emergency Engine Stop Switch

The emergency stop switch attaches to the operator of the boat and shuts down the engine if the operator is accidentally forced away from the helm.

The switch consists of an ON/OFF switch and a switch clip/lanyard clip, which is connected between the stop clip and the operator. Should the operator move away from the controls, the clip pulls free, flipping the switch to the OFF position and stopping the engine. If the engine must be shut down quickly, a pull on the lanyard cord to release the clip from the switch will stop the engine.

To reset the switch after activation, reinstall the lanyard clip and flip switch to the UP position.



Figure 2-13. Emergency Engine Stop Switch

## Motorbox Cover

The upholstered motorbox reduces engine noise and provides protection for the passengers on board. To open, stand on the port side of the box near the observer seat, grasp the handle near the floor and pull open. The motor box is equipped with either one or two gas-filled shock absorbers (depending on model) to provide support for the compartment when opened.



Figure 2-14. Motorbox

### Warning



**Running the engine with the motor box open exposes rotating machinery which can cause injury to occupants of the boat.**



## Driver's Seat

The driver's seat can be adjusted forward and backward by pulling the lever located on front left side of the drivers seat. Pull lever outward and adjust seat as needed.

### Lumbar Support

The driver's seat is equipped with a Lumbar Support. To adjust, locate the twist knob located on the left side of the seat bottom. Turn the knob clockwise to increase lean back tension, or counterclockwise to decrease tension.

### Swivel Seat Base

Some models are also equipped with a swivel seat adjustment. To adjust the seat, release the lever directly below the front center of the drivers seat area by lowering to the bottom of the seat base. Locate the twist knob on the left center of the seat base, (this knob is different than the Lumbar Support) and turn counterclockwise to loosen. The seat should swivel freely. To reset the seat position, simply reverse these steps.



Figure 2-15. Bolster Seat



Figure 2-16. Lumbar Adjuster



Figure 2-17. Seat Adjuster

## Integral Self Draining Ice Chest

This item is available on most model boats and can be found either in the observer seat base, center floor or under bow cushion seating areas. The melted water will drain into the bilge area of your boat.

## Sundeck

Most boat models are equipped with a standard sundeck feature designed for sunbathing comfort.

### Warning



***The Sundeck is not to be used while the boat is in operation. Serious injuries or death could occur to persons not seated properly should the boat come to an abrupt halt.***



Figure 2-18. Sundeck

## V-Drive Engine Access Hatch

An engine access hatch is located behind the rear observers' seat on the V-Drive. Access allows the ability to service engine for required maintenance and for additional storage on both sides of the engine.

### Warning



***Ensure the safety pins located in the storage compartment are inserted into the hatch assembly. Failure to do this could allow your engine hatch door to open while under way causing damage to your boat and others.***



Figure 2-19. Engine Access Hatch

## Ski Pylon

The patented, pivoting-head ski pylon is a telescoping aluminum post located directly in front of the motor box. Minimal maintenance is required, but once a year remove the swivel pylon head and re-grease with a high temperature bearing grease. This will increase use of the pylon and reduce normal wear and tear. To use, pull pylon up, rotate clockwise and lower until in locked position.

### Warning



***Malibu Boats' "Pivoting-Head" ski pylon is designed for normal water skiing activities: slalom, jumping, kneeboarding, tricks, and barefooting. Any other uses such as parasailing, kite flying, towing pyramids of skiers, etc., may over-stress the pylon and possibly cause personal injury and/or equipment damage. DO NOT overload the pylon or use it for anything other than watersports.***

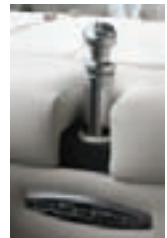

Figure 2-20. Pivoting-Head Ski Pylon

## Swim Platform

A removable swim step is located on the stern of the boat to provide easy access into and out of the water for boat skiers and swimmers. To remove, disconnect the pins located on each side the platform brackets, and, depending on model, either lift or slide back on platform. To replace, reverse these steps. Be sure the pins are securely attached.

### Warning



***DO NOT use the boarding platform for any other purpose than boarding the boat or preparation of entering the water, and DO NOT use the boarding platform when the engine is running.***

### Warning



***A spinning propeller or carbon monoxide can cause serious injury or death. Stay off and keep away from boarding platform while engine is running. The boarding platform must be attached when the boat is in use.***



Figure 2-21. Swim Platform



Figure 2-22. Swim Platform Pins

## Navigational Lights

As required by the U.S. Coast Guard, all recreational vessels are required to display navigational lights between sunset and sunrise and other periods of reduced visibility. All Malibu Boats are equipped with bow and stern navigational lights.

The bow light located at the tip of the bow is two colored — red and green, and is used to keep others aware of your presence when operating your boat at night.



Figure 2-23. Bow Light

A covered, two-pronged connector can be found on the top of the transom. The stern light is plugged into this connector when needed and stored under the rear passenger seat when not in use.

## Storage Areas

### Bow Storage Area

Access to a large storage area located in the bow of all models is accessible by lifting the bottom-lifting strap of the observers' seat back. The size of the storage differs between open and closed bow versions. On open bow boats the seat cushions can be removed to provide additional storage.

### Gunnel Ski Storage

Conveniently located on both sides of the boat, these storage areas are ideal for the storage of water skis, and other items.

### Floor Ski Storage

Located on the floor between the driver's and observers' seats on open bow models with walk-through, is a panel that when lifted provides access to a large area that can be used primarily for storage of water skis. This area can also be used to store beverages, if desired.

### Transom Storage

Some boat models are equipped with transom ski storage. Depending on the model, the storage is accessible from either the interior by lifting the observers' seat or from the transom swim platform by lifting the hatch cover. Most models are equipped with a locking device for the secure storage of your ski items.



Figure 2-24. Lockable Transom Storage

## Drain Plugs

Your Malibu is equipped with two or three drain plugs; one located at the transom of your boat and the other directly below your engine/drive train. On the walkthrough open bow models, you will find an additional drain plug in the ski locker or ballast area of your boat directly in line with your bilge pumps.

### Transom Drain Plug

This plug is located in the center of the transom at the bottom edge, and is provided to allow for drainage of the bilge area, when needed.



Figure 2-25. Transom Drain Plug

### Warning



**Ensure all drain plugs are secure prior to launching your boat. Damage caused as a result of these plugs not being installed will not be covered under your Malibu warranty.**

### Bilge Drain Plug(s)

A T-handled, brass bilge drain plug is located in the engine compartment of all models. Location is normally directly below the drive-train unit. To access, lift motor box and look aft of the ski-tow pylon, and forward of the engine. On the V-drive models, the T-handle can be found by lifting the rear passenger seat. The T-handle is located just below the V-drive unit.



Figure 2-26. Bilge Drain Plug

### Warning



*Ensure that all transom and bilge drain plugs are securely in place before placing the boat in the water.*

## Speedometer Pickup

Your boat is equipped with a Paddle wheel speedometer pickup, which can be found directly under the running surface of your boat. The paddle wheel is used to measure static water by rotation of the paddle wheel unit. This information is transferred to the dash computer and a computer program converts information which is transferred to the speedometer gauge.



Figure 2-27. Thru-Hull Paddle Wheel Pickup

See troubleshooting section of this manual for basic maintenance information.

## Tilt Steering Wheel

The tilt steering wheel allows for maximum driver comfort. To adjust the height of the wheel, simply press down on the lever located under the wheel. Move the wheel to the position that is most comfortable. When the wheel is in the desired position, simply release the lever to lock the wheel in place.

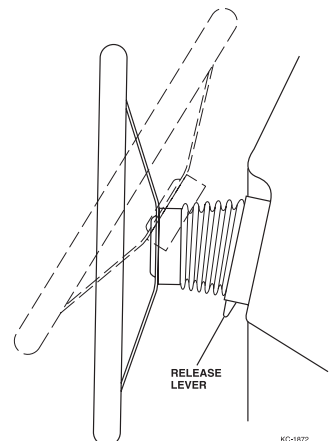

Figure 2-28. Tilt Steering

## Exhaust

The exhaust system is used to remove engine exhaust fumes. To ensure that your boat's exhaust system is working correctly, it is important that you inspect for exhaust leaks. The following information will allow you to check these systems. Keep in mind that you will be checking engine while turned on, and that you will need to take safeguards against getting yourself or others caught in the moving parts. Use extreme caution while performing this task.

- Turn engine off and disconnect the engine safety switch. Be sure the throttle shift control is neutral. The engine must be cool.
- Open the engine and visually check the exhaust system from the engine to the transom for obvious damage.
- Reinstall engine safety switch and start the engine with engine compartment open. Check hose connections between the exhaust manifolds and the muffler for leakage.
- If leakage is apparent, tighten the hose clamps, being careful not to crimp the hose. See your Malibu dealer for parts and or service.

**Notice :** The 2008 Monsoon engine equipped with the ETX Catalyst Exhaust Manifolds may produce an unusual smell which is characteristic of an engine with a catalyst exhaust system.

---

## Ventilation

The ventilation is used to remove potentially hazardous accumulation of explosive vapors from the bilge areas of your boat's hull and engine compartment. Therefore, proper ventilation is essential to the safety of the boat and persons in or around the boat structure.

Your boat is equipped with a ventilation system that will ensure complete removal of these dangerous fumes. However, it is your responsibility as the operator of the boat to ensure these systems are working efficiently. The boat's primary source for expelling fumes from the boat is the blowers located in the bottom of the bilge and at the transom venting points. See Section 2, page 2-1.

Your boat is also equipped with a natural air-intake that forces air through a venting system on the deck of your boat, and channels air from the bilge to the transom vent.

### Cooling

Most boats will be cooled with a continuous intake of lake water circulating it around engine components.

### Closed Cooling System

If your boat is equipped with an optional closed cooling system, you will need to maintain correct fluid levels.

- Open engine compartment and remove reservoir cap.
- Ensure coolant is to the top of the reservoir filler neck.
- Use Sierra Anti-Freeze.

**Notice:** To ensure we are always mindful of our environment; it is an Indmar and Malibu Boat recommendation to use Sierra Brand antifreeze because of its propylene glycol formulation. SIERRA Antifreeze is less toxic and safer than ethylene glycol coolants to children, pets and wildlife, in case of spills, leaks, boil-over or careless disposal.

**Caution** | *The engine must be cool when checking the coolant level. Hot coolant and steam under pressure may cause injury.*

---

## Optional Equipment

### Heater

If your boat is equipped with a heater, you will find an ON/OFF accessory switch located on the dash panel. Located at the base of the observer seat walkway is a snorkel tube that can be pulled out and directed wherever you like within a five-foot radius. Please refer to the information provided in your owner's packet for specific use.



Figure 2-29. Heater

### Boat Cover

If your boat is equipped with this option, know the type of cover you are placing on your boat. Some Boat Covers have been made strictly for mooring and storage only, and some have been made for storage and travel. If you question the type of cover that you have purchased, check with your Malibu dealer for assistance.



Figure 2-30. Boat Cover

### Warning



***Damage caused to your boat as a result of improper cover use is not covered under your Malibu Boats warranty. Damage can result from wind whipping, and possibly cause abrasions to your gelcoat surface. Use the proper shipping cover for travel purposes.***



### Stereo

The stereo head unit is located in the starboard side walk-through panel (in the shifter panel above the shifter in Ride models). To turn the stereo on, the dash ignition key switch must be turned on. The key can be turned to the left if you will not be running the boat. See Figure 2-31. Some systems, if equipped, will have an optional remote pad located at the back of the boat either in the passenger area, or exterior transom. For specific stereo use, please refer to the stereo manual that was included in your owner’s packet. Standard on all boats equipped with stereo system is an MP3 input line. See instructions found in your owner’s packet for specific use.



Figure 2-31. Stereo

If your boat was equipped with optional sound equipment to include CD changer, amplifier or subwoofer, please refer to these specific manuals included in the owners’ packet for use.



Figure 2-32. Stereo Remote

### Stereo Controls

#### POWER ON/OFF Button (1)

Push the PWR button (1) to turn on the unit. Push it again to turn off the unit.

#### SEL and VOL Button (2)

##### 1. Audio control (VOLUME/BASS/TREBLE/BALANCE/FADER)

By quickly pressing the SEL (2) button, you can select which of the below features to set:

- VOL display - volume control > press button (2)>
- BAS display - bass tone control > press button (2)>
- TRB display - treble tone control > press button (2)>
- BAL display - balance control > press button (2)>
- FAD display - fader control > press button (2)>

Use the VOL up/down button (16) to adjust. In each mode, the waiting time for adjustment is about 5 seconds. If the waiting time is over, the unit returns to the last displayed mode of Radio, USB/NAND (internal memory), CDC, iPod, SIRIUS or CD mode. These settings are indicated on the display window.

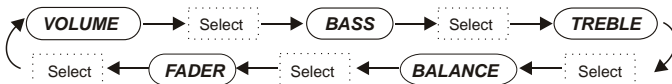

Figure 2-33. Stereo Functions

##### 2. Beep 2nd, I-Vol, Area and DSP Selection

When the SEL button (2) is held over 2 seconds, the unit will be operated as below:



Figure 2-34. Stereo Functions

**a. Beep 2nd**

In the Beep 2nd mode, you can control Beep on or Beep 2nd by pressing VOL up/down.

- Beep on: You can hear “beep” sound when you press any button.
- Beep 2nd: You can hear “beep” sound when you press any button over 1.5 seconds.

**b. I-Vol**

By pressing the SEL (2) button again, the unit will turn to I-VOL mode (Initial Volume Level Adjustment). You can adjust the I-Vol to the level you want by using VOL up/down button. After setting the initial level, the volume will default to this level every time the unit is powered on.

**c. Area Selection**

By pressing SEL (2) button again, the unit will be in Area selection mode. Then use VOL up/down button to choose USA or EUR. Press and hold BD/FN for 2 seconds to confirm and save selection.

**d. SUB-W**

By pressing SEL (2) button again, the unit will be in Sub-woofer selection mode. Then press VOL up/down button to choose SUB-W on or off.

**e. DSP**

Choose from flat, classic, pop or rock by pressing the SEL (2) button again. Adjust with VOL up/down button.

**Volume Control**

Press the VOL up/down button to increase or decrease the volume level.

**- Bass control**

Press VOL up to increase the bass.

Press VOL down to decrease the bass.

**- Treble control**

Press VOL up to increase the treble.

Press VOL down to decrease the treble.

**- Balance control**

Press VOL up to decrease the left speaker volume.

Press VOL down to decrease the right speaker volume.

**- Fader control**

Press VOL up to decrease the volume level of speakers connected to the rear channel.

Press VOL down to decrease the volume level of speakers connected to the front channel.

**“MODE” Button (3)**

Press this button to select Radio, CD, USB/NAND (internal memory), CDC, SIRIUS or AUX.

**BD/FN Button (4)**

In radio mode, press the BD/FN (4) button shortly to select the desired band: FM1, FM2, FM3, AM1 and AM2.

In SIRIUS mode, press BD/FN (4) button to select the SSR1 and SSR2.

---

### How to Adjust the Clock / Time (8)

Press DIS (8) button once to display the time.

1. Press and hold the DIS (8) button until the time flashes on the display.
2. Press VOL up to set hour.
3. Press VOL down to set minutes.
4. Press the DIS button again quickly to accept the adjusted time.  
If no button is pressed within 5 seconds, the unit automatically accepts the adjusted time without further intervention from the user.

### Loudness Function (14)

In order to emphasize the bass and the treble at low volume, press the LD (14) button. To turn off loudness, press the LD button again.

### Station Tuning

1. **Manual/Seek Tuning Button (15):** Press this button quickly to activate the Seek mode. The Seek mode will automatically seek up or down the wave band and stop at the next station of sufficient signal strength. Press and hold tuning button for 2 seconds to enter manual tuning mode. The unit will revert back to Seek mode after 10 seconds without use.
2. **Manual Station Store:** Select the desired band and tune to a radio station to be memorized. Choose the preset button memory location 1-6 into which the station is to be stored, and press and hold that preset button for 2 seconds. The station will now be entered into the preset memory. Six stations can be memorized on each of the FM1, FM2, FM3, AM1 and AM2 bands.
3. **A.PS - Auto Store Function (13):** Press and hold button (13) for approximately 2 seconds until you hear a beep which confirms the memory function is engaged. The unit will “search” for six strong stations and automatically store them on buttons 1-6. You can override the preset station on any button by manually setting a new frequency.
4. **Scan (11):** In Radio mode, press the SCAN (11) button to scan strong stations. At the desired station, press the SCAN (11) button again to stop scanning.
5. **Program Memory Scan:** Momentarily press A.PS and the unit will scan for stored stations. Momentarily press it again to stop scanning.

### Listening to the Music

1. **Play/Pause (5):** Push to pause CDC USB/NAND, iPod and push again to resume play.
  2. **Intro Scan (6):** Press this button to hear the first 10 seconds of each track. Press this button again to restore the player to its normal play mode.
  3. **Repeat Play Button (7):** While playing a desired track, press RPT button to play the track repeatedly. Press RPT button again to return to normal play mode.
  4. **Random Play Button (8):** Press RDM button to play all tracks in random sequence. Press RDM button again to return the player to normal mode.
  5. **Press Preset Button (9) or (10)** to choose the DISC or folder that you would like to play. (This button works when you install the CD changer or insert a USB device/iPod to the radio unit. CDC, USB and iPod is optional.)
-

6. **Track Tuning (15):** Search the tracks on the DISC, USB/NAND (internal memory) or iPod with the ▲ and ▼ buttons. To fast-forward or fast-rewind, press and hold the ▲ or ▼ button continuously.

### Remote Control (Option)

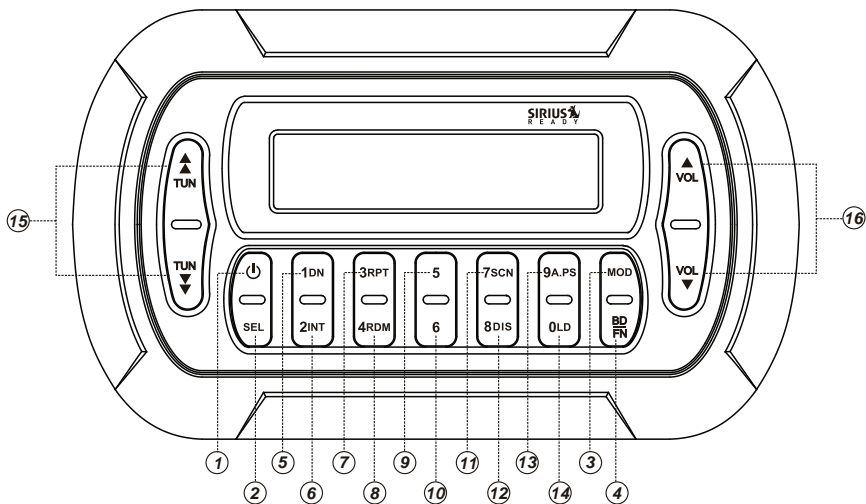

**Figure 2-35. Remote Control**

1. POWER ON / OFF button
2. SELECT button
3. MODE button
4. BD / FN button
5. Track play / pause button, radio / SIRIUS preset 1 button
6. Track intro scan button, radio / SIRIUS preset 2 button
7. Track repeat button, radio / SIRIUS preset 3 button
8. Track random play button, radio / SIRIUS preset 4 button
9. Radio / SIRIUS preset 5 button, and CDC disc Up
10. Radio / SIRIUS preset 6 button, and CDC disc Down
11. SCAN button (#7 preset SIRIUS only)
12. DISP (display) button (#8 preset SIRIUS only)
13. A.PS - Auto Preset Scan button (#9 preset SIRIUS only)
14. LOUD (loudness) button (#10 preset SIRIUS only)
15. Radio or SIRIUS tune UP / DOWN button, CD, USB/NAND (internal memory), iPod, or CDC track UP / DOWN button
16. Volume decrease or increase button

**Warning**

*Due to the many stereo accessories, and additional boat optional stereo components that can be added to this system, it is very easy to overload the boat's electrical systems capability to recharge your battery resulting in a dead battery.*

*If you will be adding additional equipment to your boat, it is recommended that you have a trained technician calculate draw and amperage of the electrical system before adding equipment. Higher Amp alternators are available to prevent an overloaded system.*

**Hot Water Shower**

If your boat is equipped with a hot water shower, you will find an ON/OFF accessory switch located on the dash panel. You will find the valves located on the port side of the motorbox compartment. The shower head can be found in the port gunnel sides. You should find specific instructions on the use of your hot water shower in the packet of materials you received with your boat.



Figure 2-36. Shower Head



Figure 2-37. Shower Valve

**Pull-Up Cleats**

Pull-Up cleats are available for all boat models. These cleats will sit flush on the side of the boat deck when depressed. To pull up the cleats, simply press the screw/button located in the center of the cleat. To depress the cleat, simply press the cleat downward until it locks into place.



Figure 2-38. Pull-Up Cleat

**Docking Lights**

The docking lights should only be used during slow speed docking maneuvers. The lights are activated by a switch on the accessory switch panel and have a 10 amp circuit breaker. Bulb access is through the lens cover outside the boat. Replacement bulbs:

- Standard Lights: 12V 30W EXT
- 25' Lights: H7614 Sealed Beam

### Port-a-Potty/SaniPottie (Sunscap 25 model boats only)

The portable port-a-potty provides simple and convenient disposal of waste for use in your boat while on the water. Before using the optional Port-a-Potty toilet, refer to your owner's manual that came in your owner's packet for complete operating instructions.



Figure 2-39. SaniPottie

### Pump-Out-Port-a-Potty

Also available as a secondary option is the Port-a-Potty, available as an upgrade to the standard SaniPottie. The unit can be cleaned via a 1-1/2" deck drain that will fit most marinas' pump-out facilities.

## Wedge

The Malibu Manual Wedge foil is a solid, one piece, welded design constructed from solid stainless steel. The wedge foil no longer locks in the down position. It is designed to move up or down freely and locate in the down position.

To lower wedge unit, depress spring loaded pins and lower foil. Be sure to raise and lock foil in the up position each time after use.

If your boat is equipped with the Wedge option, you will find that the unit has two positions - DOWN or UP. To adjust wedge position, access wedge through the swim platform door.



Figure 2-40. Wedge Down



Figure 2-41. Wedge Up

### Caution

**Ensure both spring loaded pins are engaged before taking off.**

### Warning



**Excessive speeds over 30 MPH could cause adverse handling conditions. It is recommended that you put the Wedge unit in the UP position if you will be traveling over these speeds.**

---

### Scarpa Suppression Plate (SSP)

The Scarpa Suppression plate is an optional add-on feature available for boats built with the Wedge boat bracket installed, used to enhance slalom ski wake characteristics on Response model ski boats. The plate is installed to an existing Wedge bracket.



**Figure 2-42. Scarpa Suppression Plate (SSP)**

### Optional Malibu Launch System (MLS)

The Malibu Launch System (MLS) ballast system allows water to be stored on board to increase hull weight for larger wakeboard wakes. Depending on model the MLS can be available as front and rear ballast tanks. If your boat is equipped with this feature, locate the MLS drain and fill rocker switch on the dash accessory panel; press switch up to fill, or down to drain.





## Chapter 3

# OPERATION



*Everyone benefits from the safety of others.*

## Trailer

The trailering information contained in this section describes general guidelines and procedures used by many boaters. We recommend, in addition, that you always follow the specific information provided by the manufacturer of your trailer.

### Load Carrying Capacity

The certification label attached by the manufacturer on the left forward side of the trailer will show the maximum load carrying capacity of the trailer. The label is required to show the Gross Vehicle Weight Rating (GVWR), which is the load carrying capacity plus the weight of the trailer itself. Be sure that the total weight of your boat, gear and trailer does not exceed the GVWR. Verify tire pressure for load capacity.

**Notice:** Consult your trailer dealer for other state regulations concerning brakes, lighting and other equipment options.

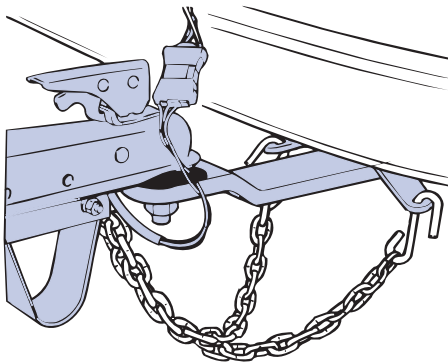

**Figure 3-1. Trailer Hitch**

KC-1700

Most boat trailers connect to a ball hitch that is bolted or welded to the towing vehicle. Clamp-on bumper hitches are not recommended.

The trailer hitch coupler must match the size of the hitch ball. Never use a hitch ball that does not match the trailer coupler. The correct ball diameter is marked on the trailer coupler.

### Hitch

Hitches are divided into classes that specify the gross trailer weight (GTW) and maximum tongue weight for each class. Always use a hitch with the same class number as the trailer, or greater.

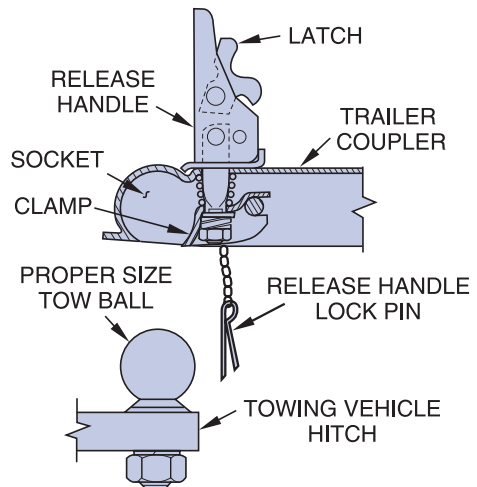

KC-1651

## Safety Chains

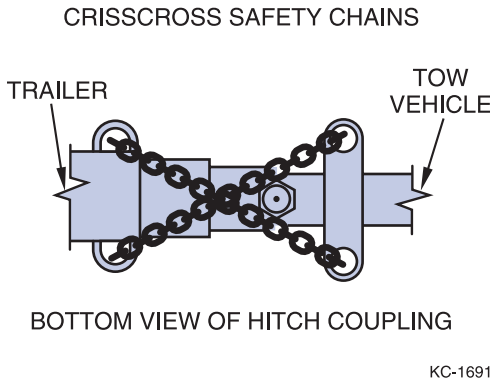
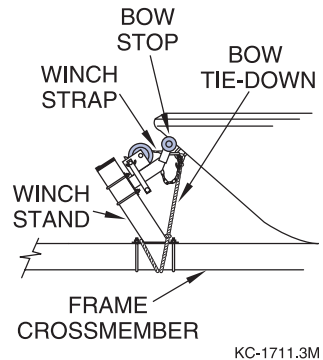

**Figure 3-2. Safety Chains**

## Tie-Downs

Making sure your boat is held securely in place on the trailer hull supports is extremely important, especially when underway. Regardless of your trailer make or model, there are two key areas to consider:

- **Bow Tie-Downs:** A bow stop to hold the front of your boat in place is located on the winch stand. It should be positioned so that the winch line pulls straight and is parallel to the trailer frame. A separate tie-down should then be attached to hold the boat downward and forward. This may be accomplished by a line from the bow eye to an attachment point on the trailer frame or winch stand.



**Figure 3-3. Bow Tie-Down**

- **Rear Tie-Downs:** It is very important to be sure the transom of your boat is resting fully and securely on the supports provided at the rear of the trailer, and that it remains in place when parked or underway. Special rear tie-downs are available for this purpose. Check often to be sure the rear tie-downs are securely locked in place and tight enough to prevent any movement of the boat.



**Figure 3-4. Transom Tie-Down**

## Backing the Trailer

Backing the boat trailer may sometimes be a difficult task. It is recommended that you practice backing the trailer in a vacant lot or open area before attempting it at a congested boat launch.

Follow these basic rules when backing:

- 1) Turn the front vehicle wheels in the opposite direction in which the trailer is to travel.
- 2) Back vehicle normally once the trailer turn is started.
- 3) Have your vehicle equipped with a right hand mirror, as required by law when towing.

## Launching

Following are some helpful tips to assist you with launching your boat:

- Before launching, check the type and condition of the ramp. Ramps are usually made of cement but often times are made of asphalt or even sand. When wet, these ramps can get very slick and can cause additional difficulties when launching your boat.
- Have someone assist you when backing your boat. Back the trailer to the edge of the water and stop. Be sure to properly secure your vehicle.
- Prepare for placing the boat in the water by removing any tie-down straps, disconnecting tail light connections, and attaching a line to the bow eye fitting. If you are using an outboard, be sure that the outboard unit is trimmed up. Be sure to reinstall the bilge drain plug if it has been removed.
- To launch, back the trailer into the water to a point where the boat will clear the bottom. Stop and secure the vehicle.
- Unlock the winch line from the boat. Push the boat into the water and have your assistant guide the boat with the bow line.
- Once the boat is cleared of the trailer, pull your vehicle out of the water and park it.

## Reloading Procedures

To reload, repeat the unloading procedures in reverse. Other important tips to remember are:

- Try to idle coast onto the trailer; do not power onto the trailer.
  - When pulling the boat onto the trailer, be sure the boat is centered as much as possible. The distance between the boat and runner board should be approximately equal on both sides.
  - Make sure the boat is securely in place before moving the trailer.
-

## Warning Labels

Warning labels are displayed at various locations throughout your new Malibu to point out safety hazards. It is important that you take the time to locate these labels. Do not remove or cover warning labels. Replace when illegible.



Figure 3-5. Warning Labels

## Warning Label Locations

Refer to the diagrams below for the location of each label.

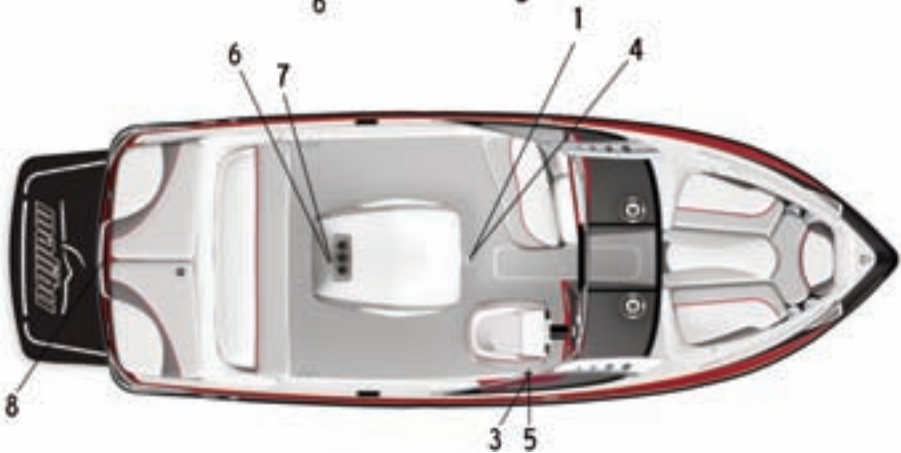
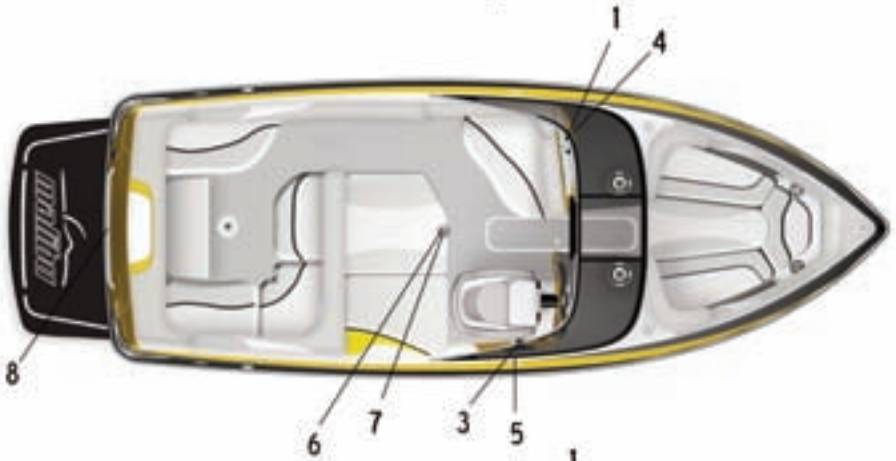
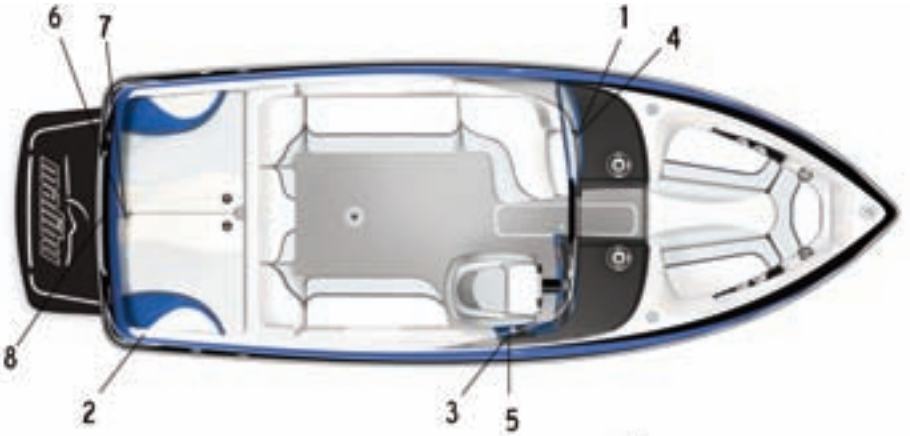

### **Load Capacity**

The U.S. Coast Guard requires that boats under 20 ft have a certification plate stating the number of persons and maximum weight a boat will handle safely under normal conditions. The certification is attached near the helm forward of the throttle.

Overloading is a violation. Do not carry more weight or passengers than indicated on the plate. The presence of the plate does not relieve the owner/operator from responsibility for using common sense and sound judgment.

**Caution** | *Never exceed the load capacity and distribute weight evenly between bow and stern, and port to starboard.*

**Caution** | **SWAMPING HAZARD**  
*Overloading may reduce the stability and seaworthiness of the boat.*

- The weight of all persons and gear including ballast bags, water bladders ballast tanks and fat sacks should never exceed the U.S. Coast Guard Maximum Weight Capacity listed on the capacity label.
- When determining the total weight on board, calculate the weight of water at 9 pounds per gallon. Be sure to add the weight of the water to the weight of the persons and gear.

## Fueling

It is very important to take special precautions to avoid spillage while fueling your boat. Gasoline vapors are heavier than air and will develop in the lower cavities of the boat, such as the bilge.

### Warning



***Do not allow the fuel tank to empty completely during operation. Doing so may damage the fuel pump. Damage from running fuel systems empty is not be covered under standard warranty.***

Below is a list of guidelines you should follow when fueling your boat:

- 1) Extinguish all cigarettes and other flame or spark producing items.
- 2) Make sure all power is off, and do not operate any electrical switches.
- 3) Be sure to wipe off any spillage that may have occurred.
- 4) Operate the bilge blower for a minimum of four minutes before starting the engine.

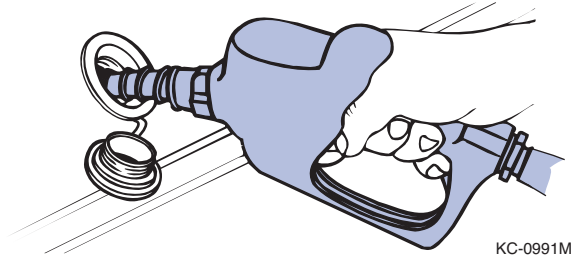

KC-0991M

Figure 3-6. Fueling

### Caution

***Do not overfill fuel tank. The fuel tank will expand and contract based on weather conditions, and can cause fuel to spill out the fuel exhaust vent. Damaged caused to your boat from leaking fuel due to overfilling is not covered by your warranty.***

## Starting

### First Start-Up of the Day

On the first start-up of the day, you may find it beneficial to “key up” once or twice to prime the fuel system prior to cranking the engine to start. The fuel system pressure will drop after a few hours of non-use. To prevent long crank times when starting for the first time, turn the key ON once to prime the fuel system.

This is a “High Pressure” fuel system. If you ever smell a strong fuel odor, shut down immediately and inspect for leaks.

**Notice:** The PIT fuel system is not to be serviced by anyone other than a Malibu Factory Trained and Certified Technician. Special tools and training are required to service this fuel system.

Pay close attention to the information regarding the break-in period listed in your engine owner’s manual. Top engine performance is dependent upon following the guidelines listed.

### Pre-Start Checklist

A routine pre-starting procedure should always be carried out before the first start-up of the day. Below is a list of basic, necessary checks to perform before starting your engine.

- 1) Replace drain plugs.
- 2) Check oil and transmission fluid levels.
- 3) Check fuel supply.
- 4) Inspect the engine compartment for water or fuel leaks.
- 5) Operate bilge pump until bilge is dry.
- 6) Operate blower for a minimum of four minutes to expel fumes.



## **Starting the Engine**

Malibu boats are equipped with sensors that constantly monitor various functions of the boat. Certain functions, if outside of pre-determined operating parameters, may activate an alarm located under the dash. When the ignition key is turned ON, the alarm will sound to indicate it is operating. Once the engine is running, the alarm should be off unless a problem is detected. If the alarm sounds during operation, stop the boat as soon as possible and turn off the engine. Investigate and correct the problem before returning to operation. Pressing the ENTER button on the display will silence the alarm for four minutes. Following is a list of monitored functions that can activate the alarm:

### **Engine Oil Alarm:**

RPM's above 300 and below 1000 with oil pressure below 4 psi.  
RPM's above 1000 with oil pressure below 18 psi.

### **Engine Temperature Alarm:**

RPM's above 300 with temperature above 203° F. Alarm will reset when engine cools below 198° F.

### **Battery Voltage Alarm:**

Voltage drops below 11 V.  
Voltage is above 16 V.

### **Water Depth Alarm:**

Water is shallower than water depth alarm setting.

Refer to Section 4, Care and Maintenance, Electrical, for more information on the alarm. Please refer to your engine owner's manual for the proper starting procedures.

---

## Shifting/Running

The throttle lever is located to the right of the driver. When the throttle is vertical, it is in the “NEUTRAL” position.

Located at the base of the throttle you will find the shift lock. Pulling outward on this button disengages the transmission, thereby allowing for use of the throttle without engaging the transmission. This is needed for starting or warm-up of the engine. Be sure to position the throttle vertically (in neutral) before re-engaging the transmission by depressing the button.

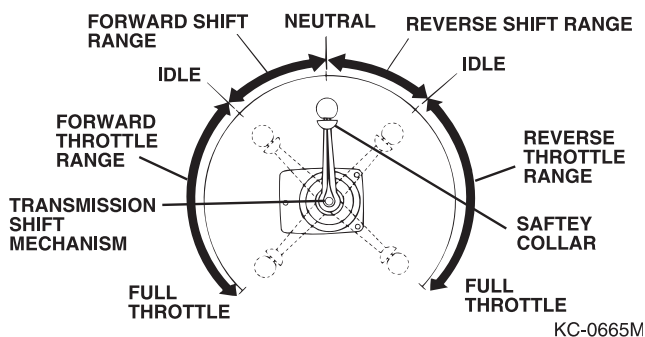

Figure 3-7. Throttle Positions

When engaging the transmission from neutral to either forward or reverse, you must pull up on the safety collar located directly below the throttle lever knob.

**Notice:** For more information regarding the safe operation and maintenance of the throttle control, refer to the separate instructions located in the information packet shipped with your boat.

## Steering

It is important that you get the “feel” of your boat’s steering system. Turn the wheel from full left to full right, and make sure the rudder is turning accordingly. The system should operate freely and smoothly.

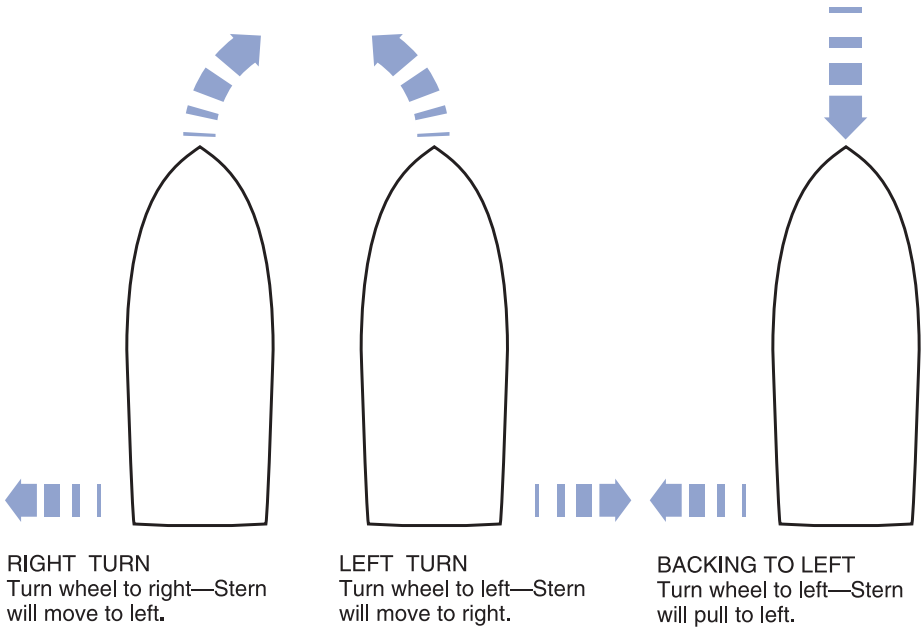

KC-1071R

Figure 3-8. Turning With A Rudder

**Warning**



***The steering system must be in good operating condition for safe boat operation. Frequent inspection, lubrication, and adjustment by your dealer is recommended.***

All boats have a tendency to wander somewhat at slow speeds. A natural reaction to this effect is to steer the boat back and forth in an attempt to compensate for wandering. Invariably, the compensation will result in oversteer and only worsen the effect. Keep the steering wheel in the center position, the boat will wander back and forth somewhat, but the overall course will be a straight one.

## Maneuvering Techniques

Steering response depends on three factors: engine position, motion and throttle.

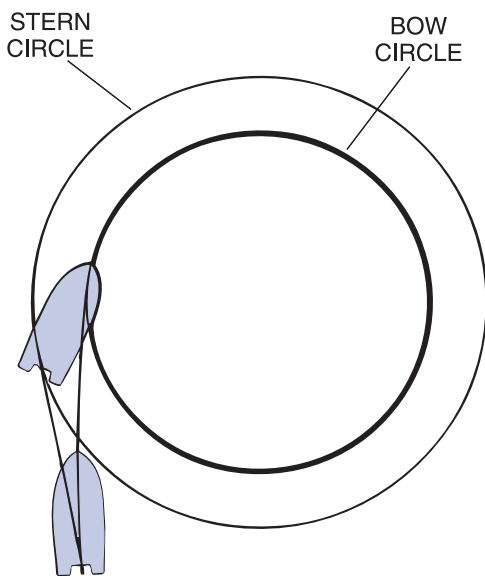

**Figure 3-9. Stern Push**

KC-1470

his advantage. Unequal thrust is an aspect shared by all single engine propeller-driven watercraft. A clockwise rotation propeller tends to cause the boat, steering in the straight ahead position, to drift to starboard when going forward, and to port when going backward. At high speed, this effect is usually unnoticed, but at slow speed; especially during backing, it can be powerful. For this reason, many veteran boaters approach the dock with the port side of the boat toward the dock, if possible.

Like an automobile, high speed maneuvering is relatively easy and takes little practice to learn. Slow speed maneuvering, on the other hand, is far more difficult and requires time and practice to master.

When making tight maneuvers, it is important to understand the effects of turning. Since both thrust and steering are at the stern of the boat, the stern will push away from the direction of the turn. The bow follows a smaller turning circle than the stern.

The effects of unequal propeller thrust, wind, and current must also be kept in mind. While wind and current may not always be present, an experienced boater will use them to

## Stopping

When stopping the boat, it is important to remember there are no brakes to allow coming to a complete, immediate stop. To stop your boat, anticipate ahead of time and begin slowing down by pulling back on the throttle.

Once the throttle is in neutral and the engine has stopped pulling the boat forward, it may be necessary to pull the throttle into reverse to further slow the forward momentum of the boat. The reverse thrust of the engine will decrease the forward speed and slow the boat down to a safer maneuvering speed.

### Warning



***Do not use the engine stop switch for normal shut down. Doing so may impair your ability to restart the engine quickly or may create a hazardous swamping condition.***

## Docking

Docking procedures for the new boat owner usually bring surprising results. Remember, operate your boat at slow speeds to avoid accidents and practice docking to gain experience and confidence.

Once away from the dock, practice docking in open water with an imaginary dock. Pull up to the dock at a slow rate of speed. Shift the boat into neutral and drift slowly toward the dock. Shift the boat into reverse slightly to slow or stop the boat altogether.

### Warning



**Never use your hand, arm or other part of your body between the dock and boat or attempt to keep the boat from hitting the dock. The boat could push against the dock, causing severe injury.**

Follow these guidelines when docking:

- Approach docks with the starboard side of the boat if possible.
- Come to a stop a short distance from the dock, then proceed slowly.
- Have fenders, mooring lines and crew ready.
- Observe how the wind and current are moving your boat. Approach the dock with the boat pointed into the wind, if possible. If the wind or current is pushing you away from the dock, use a sharper angle of approach. If you must approach the dock downwind or down current, use a slow speed and shallow angle. Be ready to reverse to stop and maintain position.
- If there is no wind or current, approach the dock at a 10 to 20 degree angle.
- If possible, throw a line to a person on the dock and have that person secure a bow line.
- With the bow secure, swing the stern in with the engine, or pull it in with a boat hook.

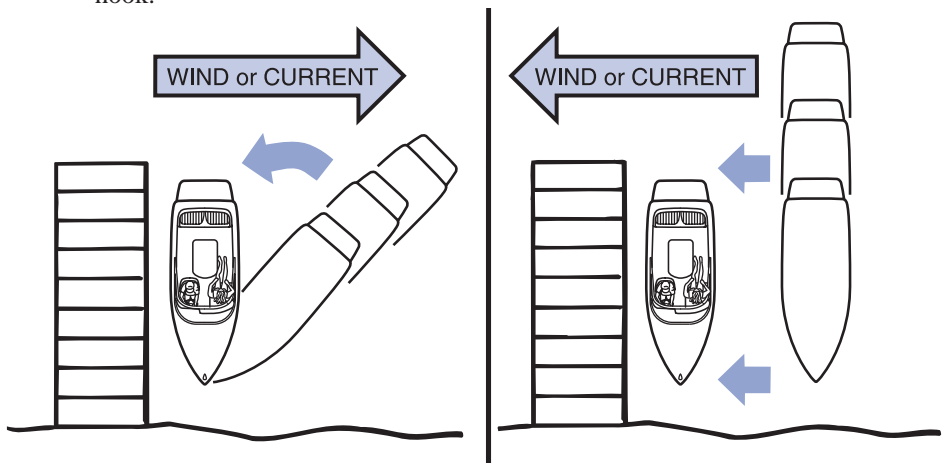

KCB-008

Figure 3-10. Docking With Wind/Current

Before tying up the boat, be sure to use enough fenders to protect the boat from damage. If possible, tie up with the bow toward the waves with a good-quality, double-braided nylon line. Tie up only to the lifting or tie-down eyes; never use the handrails or windshield frames. If the boat is to be moored for a long period of time, use chafing protectors on lines to protect the gelcoat finish. Leave a little slack in the lines to allow for some wave movement or tidal action if applicable.

The foredeck handrails should only be used for tying a “Jackline” in an emergency situation. If possible, tie up your boat with the bow toward the waves and leave a little slack in the lines to allow for movement from waves or the tide.

Follow these guidelines when departing:

- Very slowly shift into forward at idle speed.
- When the stern moves away from the dock, turn the engine away from the dock.
- Cast off bow line and back away.

If the wind or current is pushing away from the dock, cast off all lines and allow to drift until you are clear.

## High Speed Operation

A great deal of caution must be exercised when operating any boat at high speeds. This is particularly true during turns. Gradual turns can be completed at high speed by a competent driver, but it must be emphasized that sudden turns at any speed, particularly at high speed can be especially dangerous. It is possible to throw passengers from their seats and even from the boat if caution is not exercised.

## Towing a Skier

Water skiing is a collective effort involving driver, observer and skier. The degree of understanding and cooperation between them directly determines the success and enjoyment of the venture. All must understand that the skier is an extension of the boat. The driver is no longer responsible for a boat that is 20 ft long, but closer to 95 ft. Once this is understood, you are underway to a safe and secure adventure together. A healthy respect for Common Sense Rules of water skiing safety on the part of the skier, driver and observer will ensure the risk of skiing accidents is kept to a minimum at all levels of participation.

A moderate ability to swim is advisable for waterskiers, but swimming ability is no substitute for a well-fitting life jacket. The wearing of a life jacket or personal flotation device (PFD) is essential even for expert swimmers. The jacket should be Type III, approved by the U.S. Coast Guard and designated as a ski jacket. The jacket should fit snugly, otherwise it could slip up over the skier if the skier should happen to fall at high speed.

Communication between the skier and driver is essential. Standard signals have been developed by the American Waterski Association and have been accepted by most waterskiers. Once the skier is in the water and ready, the driver of the boat will take the slack out of the tow line. When the skier is in position and prepared for lift, the skier shouts "hit it" which is the signal for the driver to open the throttle for take-off. Once the skier is on plane, there are a number of hand signals that will allow communication between the skier and the driver of the boat. A copy of these signals can be found for review at your local Malibu dealership or by contacting the American Waterski Association at (813) 324-4341.

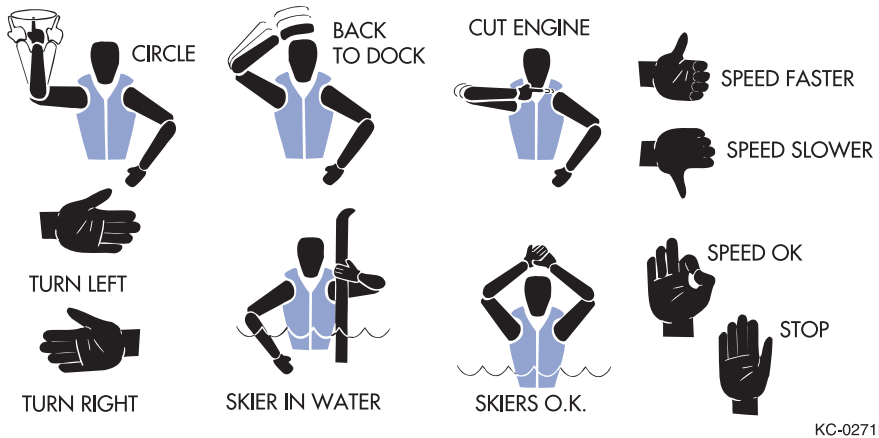
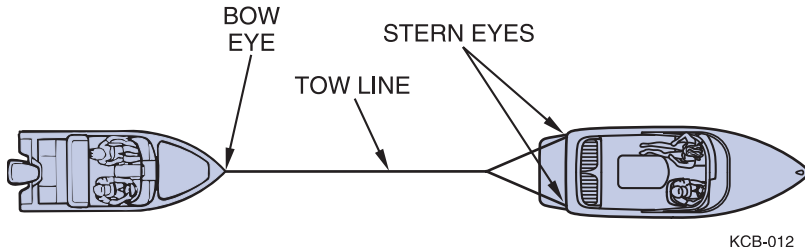

**Figure 3-11. Hand Signals**

Once a skier has fallen or is ready to quit skiing, the driver must be prepared for immediate removal of the skier from the water. The driver of the boat should keep the skier in line of sight as much as possible until the skier is reached. Once the boat is up to the skier, the driver should always turn off the engine until the skier is onboard. There should be no exception to this rule as there is always the possibility of the skier slipping or falling back into the water risking contact with the boat propeller.

## Towing Another Boat

Towing is normally a last resort because damage can be created by stress from the towing lines or uncontrollability of the boat being towed. Only when ideal conditions arise — lake is calm, the disabled boat is smaller than yours, and both boat operators know correct technique — should a recreational boat be towed by another.



KCB-012

**Figure 3-12. Towing**

Because the towing boat is the maneuverable boat and the grounded boat is not, you should pass the tow line to the grounded boat. Use double-braided line. Never use three strand twisted nylon; it has too much elasticity and can snap back dangerously. Fasten the towline as far forward as possible on the upwind or up current side of the boat being towed. Fastening it to the stern will restrict maneuverability. Attach the line to the stern lifting eyes of the towing boat. Keep lines free of propellers on both boats. Keep hands and feet clear of other boat and never hold towline after it is pulled taut.

Move slowly to prevent sudden strain on slack line.

Be ready to cast loose or cut the line if conditions become hazardous.

## Anchoring

There are many types of anchors available on the market. The choice on which one to choose depends on the usage. Contact your dealer on what anchor would suit your situation.

### Warning



***Always anchor from the bow of the boat. The boat has less chance of breaking free if a heavy wind comes.***



## Propellers

### Caution

- **A propeller can be very sharp. Be careful when you handle it. Wear a pair of protective gloves when handling any propeller.**
- **Remove your key from the ignition to prevent accidental starting of the engine.**
- **DO NOT reuse the nylon locknut or the cotter pin.**
- **DO NOT use a damaged propeller. A damaged propeller can damage your engine and/or your boat.**

Nothing is more important to the proper performance of your boat than the condition of the propeller. Even slight propeller damage can mean the loss of one MPH. Greater damage can mean considerably more speed loss. Worse yet, damage usually is not done to each blade uniformly and, therefore, sets up imbalanced vibrations that can cause fatigue damage to other parts of the engine or drive system.

Your propeller is custom calibrated for your Malibu by our Research and Design team to give maximum performance. Before installing props other than those suggested by Malibu contact your dealer, otherwise adverse handling and top speed characteristics may be experienced.

The prop is identified by two numbers, i.e., 13 x 14, and material identification such as brass or stainless steel. The first number is the diameter of the prop and the second is the pitch. The pitch is the

angle of the blades and is measured in how far the boat will travel through the water in one revolution. In this case, for every one revolution the boat will travel 14 in.

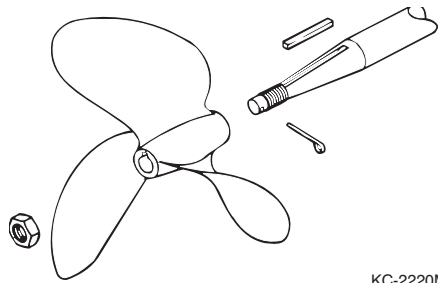

Figure 3-13. Propeller

### Warning



**Do not operate engine above the manufacturer's recommended RPM rating; severe damage could result, voiding the warranty.**

At least once a year, more often if you use your boat extensively, you should have your local Malibu dealer inspect the propeller for any possible damage.

At least once a month, if you use your boat regularly, you should check and tighten the prop nut. If it is necessary to remove the prop, use care. If the prop is not removed correctly, damage could result if it comes off the shaft too quickly and hits the ground. Whenever possible, use a prop pulling tool to remove prop, this will reduce the chance of damaging the prop.

## Removal

- 1.) Remove the cotter pin from the propeller shaft and discard.
- 2.) Wedge a piece of 1" x 4" wood between the propeller blade and the starboard side of the strut and rudder.
- 3.) Remove the nylon locknut and discard.

Use a propeller puller to remove the propeller, then remove the key from the keyway. Inspect the keyways and key for any damage.

## Installation

Before installing the prop, look at the keyway on the shaft and in the propeller. The key should slide freely in both keyways. **DO NOT** use the prop nut to advance the prop onto shaft.

If the key has slight damage or burrs, remove them by filing the flat sides or replace the key. **DO NOT** file the key beyond its normal shape or size.

- 1.) Rotate the shaft until the keyway is "up."
- 2.) Place the key in the shaft keyway. Align the keyway in the prop to the key. The prop will only slip on in one direction. Once the prop starts to go on the shaft, push the propeller "solidly" on the shaft and make sure you feel that it is seating properly.
- 3.) Wedge a piece of 1" x 4" wood between the propeller blade and the port side of the strut and rudder.
- 4.) Install a new nylon locknut and torque the nut to maximum of 30 ft-lbs (40.7 N•m).
- 5.) Install new cotter pin. Bend the retaining ends of the cotter pin in the opposite directions. Make sure the cotter pin is snug and cannot rotate.

## Malibu Exclusive Adjustable Rudder System

Your Malibu steering is custom calibrated at the Malibu factory at the time of manufacturing. However, it may be necessary from time to time to adjust the steering due to normal operations. Malibu Boats' unique adjustment feature allows custom calibration to your specific driving needs. The Malibu Adjustable Rudder system allows you to increase or decrease the amount of load that is typically on the steering system.



**Figure 3-14.**  
**Adjustable Rudder**

If it is determined that your rudder needs adjustment, you can do so by adjusting tunable feature located on the rudder surface. Locate the 1/8" set-screws. Loosening the set-screws will release the adjustment tab. If your boat pulls to the right, turn the tab to the right 1/8th to 1/4". Do not move beyond this point. Only minor adjustments are needed to make a correction. Note that it may take more than one adjustment to get the desired setting. Tighten the set-screws when adjustment is completed.

**Warning**

***Make sure the set-screws are tightened after each adjustment. Failure to tighten the set-screws could cause erratic steering and serious damage could result. If you are unsure of the correct procedure to conduct this adjustment, it is recommended that you return your boat to your local Malibu Boat dealership for assistance.***

## Corrosion Protection

Galvanic corrosion (electrolysis), is the break-up of metals do to the effects of electrolytic action. When two dissimilar metals are immersed in a conductive fluid such as salt water, an electric current is produced, similar to that of a battery. As the current flows, it takes with it tiny bits of the softer metal. If not stopped, a great deal of damage can occur.

If you operate your boat in salt or brackish waters, you should have your boat equipped with a transom mounted zinc anode to prevent damage to the parts coming in contact with the water. The zinc anode being the softer metal will deteriorate and erode much faster than the other metals in the boat. Inspect the anode periodically and replace as needed. Consult your local Malibu dealer for this part.

### Salt Water Corrosion

The entire boat should be rinsed with fresh water immediately after use in salt water. If the boat is used primarily in salt water, wash the hull monthly and apply corrosion inhibitor to all hardware. See your dealer for products suitable for the marine salt-water environment. Fresh water internal flushing is recommended when used in salt, polluted or brackish waters. Flush the entire cooling system with fresh water for at least five minutes after use in these waters. See your Malibu dealer for appropriate flushing devices.

**Notice:** **Salt water is commonly very harsh on all components of boat. Salt water corrosion is not covered under your Malibu Boat or Indmar warranties. It is the boat owner's responsibility to understand and ensure they have taken proper precautions to safeguard boat.**



## Chapter 4

# CARE AND MAINTENANCE



*The following guidelines discussed in this section will protect the investment you have made by preserving the beauty and performance of your new boat for years to come.*

## Interior

### Carpet

Your Malibu boat is equipped with a top quality, all-weather indoor/outdoor carpet. It is essentially waterproof and fade resistant. Occasional vacuuming and scrubbing with soap and water will remove embedded dirt and grit.

### Vinyl

All upholstery items aboard your boat are made of a tough marine vinyl that is easily cleaned with a mild detergent and warm water. After washing the vinyl, be sure to dry it thoroughly.

Our materials are mildew resistant, but there are no products available to us that are mildew proof. Therefore, we also recommend that you dry the upholstery thoroughly at the end of each day's boating activity to prevent mildew which will rot the upholstery threads and backing. We also recommend that you tip up all seat base cushions on edge after each use to allow any accumulated water to drain.

### Warning



***In some instances, color or dye transfer can occur when wet clothing comes in contact with vinyl. If this occurs, the vinyl should be cleaned immediately to avoid permanent staining. Unfortunately, due to the porous nature of the upholstery, you may find that the dye has set into the vinyl surface, and you cannot remove it. If this should occur, it is recommended that you contact Final Finish/MSG to get assistance in cleaning.***

***Upholstery finish stains caused by secondary sources are not covered under your Malibu Boats Warranty.***

It is important to keep your vinyl clean at all times. Some substances can stain the vinyl if you leave them on for even a short period. Remove any contaminant and clean the area immediately. DO NOT use Formula 409® Cleaner or any silicone based products. Some household cleaners, powdered abrasives, steel wool, industrial cleaners, dry cleaning fluids and lacquer solvents can damage and discolor. DO NOT use these types of cleaners.

Common stains and steps to treat:

	Step #1	Step #2	Step #3
Chewing gum	d	a	d then a
Chocolate, coffee, tea	b	b	
Crayon	d	b	
Eye shadow	e	b	e then b
Grease	d	b	
Ink, ball-point	e	b	
Ketchup	a	b	
Lipstick	a	b	
Marker, permanent	e	b	
Mildew or wet leaves	d	b	a
Mustard, yellow	d	b	
Oil, engine	b	b	b
Paint, latex	a	b	
Paint, oil based (dried)	a	b	
Paint, oil based (fresh)	d	b	
Paint, spray	c	b	b
Polish, shoe*	a	b	
Suntan lotion*	d	b	
Tar/Asphalt	a	b	

Use the chart above to clean common stains:

- a. Medium-soft brush, warm, soapy water/rinse/dry
- b. Meguire's Quick Clean #52
- c. One (1) tablespoon ammonia, 1/4 cup hydrogen peroxide, 3/4 cup water rinse/dry
- d. Wipe or scrape off excess (chill gum with ice)
- e. Denatured Alcohol/rinse/dry

After all cleaning methods, rinse well with water.

\* Shoe polish, wet leaves and some other products contain dyes that stain permanently. Some suntan lotions can also stain permanently.

---

## Exterior

Your Malibu boat is highly resistant to weathering, water pollution and minor scrapes which occur during normal use. However, regular care and maintenance of your boat is a general responsibility for all Malibu boat owners. By following the boat care instructions listed below, you will be able to extend the life and beauty of your Malibu boat.

### Fiberglass and Gelcoat

The fiberglass hull and deck of your Malibu boat consist of a molded shell and exterior gelcoat. The gelcoat protects the fiberglass shell and gives all Malibu boats a smooth and shiny surface. The following are some general instructions which will help you maintain your boat's sleek appearance:

- 1) Wash monthly or more frequently, depending on use. Use a mild dish washing soap and lukewarm or cold water. Rinse your boat with fresh water and wipe down immediately to avoid water spots.
- 2) Wax the boat hull and deck after every three or four outings to decrease water friction and to lessen the potential for staining or spotting the gelcoat surface. In cases where the original gelcoat shine cannot be restored by waxing, hand buff the surface using any commercial compound. Be sure to apply several coats of wax over the area that has been polished.

### Surface Stains

Stains can appear as a result of dust, road tar, plant sap, rust from metal fittings and other materials coming in contact with your boat's exterior. Listed below is a step-by-step procedure to remove stains from your boat:

- 1) Wash area with dish washing soap
- 2) Apply a mild cleanser on a small area (3 x 3 ft)
- 3) Rinse with fresh water
- 4) Buff with a fine rubbing compound
- 5) Wax

If the stain is not removed by the dish washing soap or mild cleanser, then the next procedure is to use either denatured or rubbing alcohol. Common rubbing alcohol is excellent for removing stains.

### Scratches

Scratches to the gelcoat sometimes occur during normal use. Your dealer can usually restore the gelcoat to like-new condition.

### Underwater Corrosion

Corrosion occurs in saltwater conditions from the interaction of the saltwater and the direct current of the battery. To prevent corrosion, it is important to keep the bilge area as dry and clean as possible.

---

### Care For Boats That Are Moored

Due to gelcoat discoloration, osmosis (blistering) and algae growth, it is not recommended that you leave your boat moored for long periods of time. If your boat will be moored in fresh water or saltwater for extended periods of time, you should do the following:

- 1) Haul-out and clean your boat regularly (every 14 to 21 days). Use soap, water and plenty of elbow grease.
- 2) Apply wax after cleaning.

You should also check with your local Malibu dealer about anti-fouling paint and other products that can be applied to the hull bottom below the water line.

### Teak Wood

Care must be taken to keep teak wood from turning gray or rough. The roughing becomes more apparent as the moisture evaporates and dries out.

It is suggested that you use teak or mineral oil treatments at least four times a year to maintain the appearance of your swim platform. Use a high-quality teak oil which can be purchased at your local Malibu dealership.

For additional information on care, maintenance and warranty on your swim platform, please see the information provided in your Owners Packet.

**Notice:** Teak sealers and cleaners can damage other materials. Make sure you thoroughly remove any spills or excess. Teak should not be varnished. The natural oils in teak cause poor adhesion.

### Warning



***Avoid fire or explosion onboard. DO NOT store rags used to treat teak onboard. Store or dispose of rags properly ashore.***



## Engine/Drive Train

### Engine

For information on engine service, maintenance and break-in period, please refer to your engine owner's manual. The Required Maintenance Schedule included in this manual covers the minimum maintenance required for Indmar engine packages. The Maintenance Worksheet included in this manual outlines safety checks, lubrication and general service that should be performed at regular intervals. It is recommended that any engine replacement parts used for maintenance or repair be supplied by an authorized Malibu dealer.

### Engine Specifications

2008 Malibu Engines						
Engine Models	5.7L Carbureted	5.7L MPI	6.2L (383)	LS7	LS2/LS3/LY6	8.1L MPI
Number of Cylinders	V-8					
Displacement	350 CID (5.7L)		383 CID (6.3L)	427 CID (7.0L)	364 CID (6.0L)	496 CID (8.1L)
Bore/Stroke	4.0012 x 3.480 in. (101.63 x 88.39 mm)		4.0012 x 3.8 in. (101.63 x 96.52 mm)	4.125 x 4.00 in. (104.8 x 101.6 mm)	3.898 x 3.622 in. (99 x 92 mm)	4.25 x 4.37 in. (108 x 111 mm)
Compression Ratio	9.4:1		9.7:1	11.0:1	10.1:1	9.1:1
Compression Pressure (Note 1)	Minimum 100 PSI (690 kPa)					
Idle RPM in Neutral (Note 2)	650 ± 50 RPM					
Operating Range at WOT	4400-4800 RPM		4600-5200 RPM	5200-5600 RPM	5000-5400 RPM	
Oil Pressure at Idle	4 PSI (41 kPa) Minimum Hot				5 PSI (34 kPa) Minimum	
Oil Pressure at 2000 RPM	18 PSI (124 kPa) Minimum Hot				10 PSI (69 kPa) Minimum	
Oil Filter	Pennzoil PZ3, AC-PF25					AC-PF454 (on engine) Pennzoil PZ3 (remote)
Fuel Pump Pressure	8 PSI Maximum (55.2 kPa)		60 PSI Minimum at Keyup (414 kPa)			
Electrical System	12 Volt DC Negative (-) Ground					
Minimum Battery Requirements	650 cca/700 mca/120Ah					
Firing Order	1-8-4-3-6-5-7-2			1-8-7-2-6-5-4-3		
Spark Plug Type	AC 41-932 or 41-993			AC 41-985		AC 41-983
Spark Plug Gap	.030 in. (.76 mm)		.060 in. (1.5 mm)		.040 in. (1.3 mm)	
Base Timing at 1000 RPM (Note 3)	10° BTDC		Nonadjustable			
Thermostat	160°F (71°C)					
<b>Fluid Capacities</b>						
Crankcase (With Filter) (Note 4)	5.5 Quarts (5.25 L) with Filter					10 Quarts (9.5L)
Closed Cooling System (Note 5)	12-14 Quarts (11.4-13.3 L)					14-16 Quarts (13.2-15.1L)
In-Line 1:1 Transmission (Note 4)	1.7 Quarts (1.6 L) Dexron 3 ATF					4.2 Quarts (4L) 15W40
In-Line Reduction Gear (Note 4)	2.12 Quarts (2 L) Pennzoil 15W40					4.2 Quarts (4L) 15W40
ZF Ski Vee Transmission (Note 4)	2.12 qt (2 L) Main Gearbox, 1.0 qt (1.06 L) V-drive - Dexron 3					
ZF V-Drive Transmission (Note 4)	4.2 Quarts (4 L) Pennzoil 15W40					
Walter V-Drive	0.5 Quart (0.5 L) Pennzoil SAE 30 Motor Oil					

### Notes

- 1) Minimum recorded compression in any one cylinder should not be less than 70% of the highest recorded cylinder.
- 2) Measured using an accurate shop tachometer at normal operating temperature. Idle RPM on EFI models is not adjustable.
- 3) Timing must be set using special procedures indicated in the appropriate service manual. Timing cannot be set using conventional methods. Special tool(s) required.
- 4) Always use dipstick to determine exact quantity of oil required. Do not fill above "FULL" mark.
- 5) Do not over fill. Correct level is at the "Full Cold" mark on the coolant recovery bottle when coolant is cold.

## Transmission

Check fluid only with engine OFF and boat floating level, or level on trailer. The transmission dipstick is located on the top of the transmission. Dipsticks may be marked “FULL” or “H” (high) and “ADD” or “L” (low); maintain fluid level between the two marks.

**Caution** | *Check level immediately after turning engine off. Transmission fluid may be hot. Be careful not to burn yourself.*

TRANSMISSION	MODEL	CAPACITY	FLUID TYPE
ZF Hurth In-Line	450D	1.7 qt (1.6L)	Pennzoil Dexron II, III or MERCON
ZF Hurth In-Line	450A	2.12 qt (2L)	Pennzoil Dexron II, III or MERCON
ZF Hurth In-Line	630A	4.2 qt (4L)	Pennzoil Dexron II, III or MERCON
ZF Hurth V-Drive	630V	4.2 qt (4L)	Pennzoil Dexron II, III or MERCON

**Caution** | *Do not overfill the transmission. Overfilling can damage the transmission. Damage to your transmission due to too much or too little fluid is not covered by your warranty.*

Operate boat approximately five minutes to warm the transmission fluid. Turn engine off and disconnect the engine safety switch. Ensure throttle is neutral.

**Notice:** Check immediately after shutdown to prevent incorrect reading.

- Open engine compartment and locate transmission fluid level dipstick.
- Remove dipstick and wipe with a clean rag. Quickly re-insert the dipstick fully and immediately remove. Check the fluid level is at the full warm mark on the stick.
- Add or remove fluid as necessary to maintain the level at the mark. Use only recommended automotive transmission fluid. You will find recommended fluid types in your Indmar Owner’s Manual.

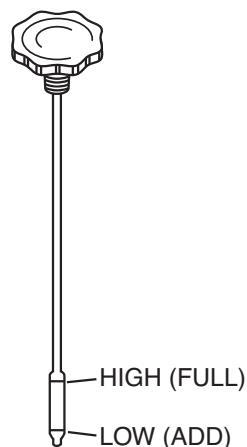

KC-2175

**Figure 4-1. Typical Transmission Dipstick**

## Manually Shift Transmission with Electronic Shift

This safety device can be used in case of a power supply failure.

**Notice:** Use this safety device only out of confined waters, with full maneuvering capability.

Follow the steps below for directions on how to manually shift the transmission with electronic shift.

### Warning



*When manually engaging the electronic transmission shifter, be sure the key is in the OFF position and all passengers are in the boat. With the manual shift option, the boat will not have NEUTRAL as a function; the boat will be in gear at all times until the manual function is disabled. The boat will start in gear and will not stop unless the key is turned off. This function is only used in case of emergency and assistance is not available. Use with caution.*

1. Identify the electronic shifter located on the left side of the transmission.



2. Slide the retainer pin out of the red cover.



3. Extract the red cover.



4. Identify the cotter pin at the end of the shaft.



5. Remove the cotter pin.



6. Remove the spacer sleeve from the shaft.



7. Turn the shaft clockwise until it bottoms out.



- 
8. This transmission is now engaged in forward gear.



9. To disengage forward gear, reverse steps 1-8 and return the electronic shift back to its original position.

Contact your local Malibu dealer for assistance with disengaging the manual shift option and returning to the original factory settings.

---

### Rudder Stuffing Box

The rudder stuffing box has a grease nipple and should be checked and lubricated annually. The rudder stuffing box is accessed through the rear center access panel directly below the fuel tank on direct drive models, and below the engine on V-drive models. Use only a marine grade, waterproof grease.

### Shaft Packing

Located in the bilge, under the rear center access panel, is the shaft packing. The shaft packing is a seal where the prop shaft goes through the hull of the boat. This seal should be checked and tightened periodically. Please note that it is normal for a small amount of leakage to occur from this seal. It should leak at the rate of about one drop every 10 seconds.

### Prop Shaft/Engine Alignment

As per Indmar's recommended routine service maintenance, it is necessary to regularly evaluate the prop shaft coupler bolts that attach the prop shaft to the engine. See Indmar Owner's Manual for proper prop shaft alignment. If the prop shaft bolts loosen prematurely, major damage to your boat structure and driveline could result. It is recommended that only a trained service technician perform this maintenance due to the complications that can arise from an improperly balanced prop shaft engine alignment.

### Warning



***Damaged caused from loosened coupler bolts and improper engine alignment is not covered under your Malibu Boats warranty, and should be part of the owner's service responsibilities to ensure system is correct. See Malibu Boats and Indmar Owner's Manuals for appropriate timelines for evaluation or checkup.***

### Optional Drip Less Shaft Packing

The optional drip less shaft packing provides drip-free use of your prop shaft coupling and will require minimal maintenance to keep the system trouble-free. Grease fitting annually, and ensure water flow tube is free from obstruction. The system uses lake water from the engine to assist in cooling. If the cooling hose is removed, water can enter the bilge area of the boat while the engine is running.



**Figure 4-2. Drip Less Shaft Packing**

---

## Fuel System

### Fuel System

All 2008 Malibu Boats are equipped with Pump-in-tank (PIT) fuel systems. This means the fuel pump is no longer mounted on the engine and is now located in the fuel tank. There are many benefits to using Pump-in-Tank; most notably is the prevention of vapor lock and improved filtration of contaminants.

This is a “High Pressure” fuel system. If you ever smell a strong fuel odor, shut down immediately and inspect for leaks.

### Warning



**The PIT fuel system is not to be serviced by anyone other than a Malibu Factory Trained and Certified Technician. Special tools and training are required to service this fuel system.**

Do not use fuel containing more than 15% MTBE. Also, fuel containing more than 10% ethanol or grain alcohol is not recommended. A higher percentage of either of the two fuel additives can cause damage to the engine and fuel system.

DO NOT mix MTBE and ethanol. Drain your tank, or use up as much of the old fuel as you can before making the switch to E10. Once done, do not go back to MTBE gas. Also, drain the tank when storing the boat, and put in additives.

Does the gas you are buying have ethanol or MTBE? By law, roadside stations must put stickers on pumps designating whether the gas has ethanol and how much. A lot of marinas do not put up stickers, so ask.

Find out when your fuel provider switched to E10 and how it was done. Old fuel and water should have been removed and the tanks cleaned to reduce the possibility of the ethanol loosening up old sludge. If they mixed ethanol with gas, you could be pumping a potential disaster into your boat.

Mixing the two additives can and will cause damage to the engine and fuel system which will void all warranties supplied by Malibu Boats LLC, and Indmar Engine Company.

Refer to the engine owners manual for further information.

---

## Electrical

### Engine Circuit Breaker

Your engine is equipped with a 35 AMP Circuit Breaker to protect the engine electrical system and components from overload, and is found on the lower right side of the engine. If your engine should lose power and will not crank, reset the breaker by firmly pressing the red button (an audible sound will be heard). For additional engine electrical issues, see your Indmar Engine Owners Manual, or contact your Local Malibu dealership.

### Main Circuit Breaker

Located adjacent to the battery is a 80 AMP Circuit Breaker. If your boat's systems lose electrical power, and you have no dash gauges or your engine does not turn over, you will need to reset the breaker to restore power to your boat's systems. To reset, find breaker switch and depress until lever locks into position.



Figure 4-3. Main Circuit Breaker

### Warning



**Power loss to the Main Breaker is an indication of serious issues to your boat's electrical and/or engine components. Contact your local dealer for evaluation of these components.**

### Caution

**If additional loads are added to the dash feeder circuits, such as amplifiers, tower lights, etc., this can overload the 60 AMP breaker. Large loads over 20 AMPS should be wired directly to the battery with proper overload protection.**

### Boat Alarms

Malibu boats are equipped with sensors that constantly monitor various functions of the boat. Certain functions, if outside of pre-determined operating parameters, may activate an alarm located under the dash. Both the engine Electronic Control Module (ECM) and the dash gauge computer may activate the alarm.

If the ECM activates the alarm, it will store a trouble code in memory. Stop the boat as soon as possible and turn off the engine. You will need to have your Malibu dealer run a diagnostics test to repair the engine and clear any codes from memory. The ECM uses the engine oil pressure, engine temperature and transmission temperature switches for input and parameters are stored in the ECM.

If the dash gauge computer activates the alarm, the Multi Function Display Panel will indicate the source of the problem. If the alarm sounds during operation, stop the boat as soon as possible and turn off the engine. You will need to have your Malibu dealer run a diagnostics test to repair the engine and clear any codes from memory. The dash gauge computer uses a separate set of sending units on the engine, fuel tank and depth transducer for input and parameters are stored in the computer.

Refer to Section 3, Operation, Starting, for more information on the alarm.



## Battery

A minimum of 650 cold cranking amps is the recommended battery size for 2008 models except 8.1 L engines. 8.1 L engines require a minimum of 800 cold cranking amps.

### Warning



**Do not connect battery cables to incorrect Terminal Post ±. Doing so may cause a reverse polarity**

**current to run through your electrical system and cause damage to your engine and other electrical components. Damage done to your boat due to incorrect terminal placement is not covered under your Malibu warranty.**

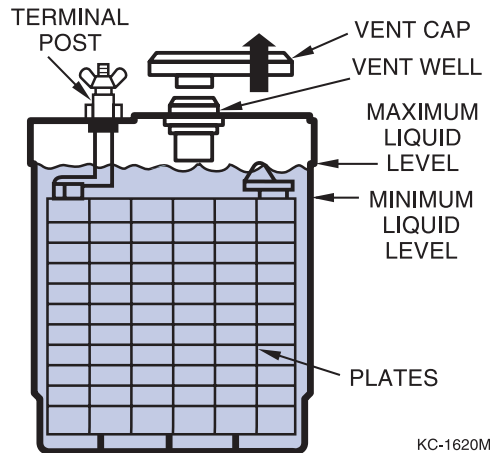

KC-1620M

**Figure 4-4. Battery Level**

Check your battery terminals frequently for corrosion and tightness. Clean terminals with a baking soda and water solution and a wire brush. Also, check the fluid levels in the cells. Usually, a level approximately 1/4 to 1/2 in. above the plates is sufficient. If needed, fill with distilled water. Some batteries are sealed and this process is not necessary. Read directions when applicable.

### Electrical Distribution-Battery Switches:

All main engine battery cables for 2008 are the larger, 2/0 size. Always use a Starter/Cranking battery, minimum size of 650 Cold Cranking Amps on the big cable. This is the starter or cranking circuit.

There are also a set of smaller #2 AWG battery cables with the positive/red coming from an 80-AMP main circuit breaker (on the smaller boats, a #6 AWG cable and a 60-AMP main breaker). These smaller cables are the feeder circuit to the boats breakers and switches. These are referred as the House circuit.

### #1 on a single battery system:

Both the cranking circuit and the house circuit are connected to the same battery. One battery running everything all connected together.

### #2 on a dual battery system:

With a battery selector switch commonly called a “battery isolator switch”; both the house and the cranking circuits are always connected together at the selector switch. You have the ability to switch between 1-2 or all of the batteries to connect to the house and starter circuits. The current to charge the batteries, will come from the starter circuit, flowing from the engine alternator to the battery switch common terminal. When the engine is running you will have the ability to charge ether #1 or #2 or both of the batteries at the same time. When the engine is off, you will pull current for both the house and

cranking circuit on which ever battery you have selected or both batteries. With this system you are required to manage the battery system, keeping both batteries charged and never run the second battery dead. Sitting listening to an amplified stereo system with the selector switch on “all” with lights on can drain both batteries. The best feature of this switch is you can disconnect the electrical system of the boat and engine, and the amperage draw for the computers and stereo memory during long and short term storage will be minimal. To maintain optimum performance, make sure to manage the batteries properly.

### **#3 The Voltage Sensitive Relay (VSR):**

The voltage sensitive relay is basically a switch that connects the cranking circuit battery to the house circuit battery, once the starter battery is fully charged. This allows the house circuit to be separate from the cranking circuit completely. This is a true isolated, separate set of circuits; house and cranking with two separate batteries. The common ground connection and this VSR switch are the only way these two separate circuits can connect. The switch is normally open, but once the engine is running and the voltage comes up on the starting battery and it is fully charged, the VSR switch closes, allowing charge current to flow into the house battery. This allows the alternator to supply current to charge the house battery and supply operational current to house loads.

Once you shut down and the alternator is no longer charging, the VSR switch will open, separating the two circuits again. Again the VSR has allowed two circuits to be separate, so now any power you draw with the engine off; will come from the house battery. You can listen to the stereo until the house battery is dead, but you can have the peace of mind knowing that all you have to do is turn the key and your boat will start. No fumbling with any switches, it's all automatic.

Now that we have separated the house and cranking circuits, we can use batteries designed for specific uses. You always need a cranking battery for the cranking circuit, but now you can use a deep cycle battery on the house circuit. Deep cycle batteries will handle the load and discharge cycles much better then cranking batteries on the house circuit. A group 24 high-ampere hour deep cycle battery is recommended for the isolated house circuit.

If you have a large stereo system and you spend a lot of time listening to it with the engine off, upgrading the house battery system to two battery's will extend the amount of time you can listen to the system before the batteries are dead and require charging. Using two deep cycle batteries in parallel on the house circuit will dramatically increase the amount of time you can listen to high end stereo systems. Contact our dealer for a battery system upgrade.

The cranking battery is the primary battery that is only used to start and operate the engine. Having the cranking circuit truly isolated from the house circuit is the ultimate upgrade; it prevents cranking voltage spikes from causing any problems with the onboard computer network. With the VSR equipped systems, you will notice that when you turn on the key, the stereo will come to life as will the dash instrumentation, yet when you crank the engine over to start, they never blink. The stereo never skips a beat and the instrumentation stays powered.

The stand alone, VSR- dual battery system does not have a disconnect switch. We recommend disconnecting the batteries prior to storage.

**Option #4, The DPST switch with VSR and dual batteries:**

This is the same basic system as the stand alone VSR option #3, but now there is a single switch that opens both the house and cranking battery circuits while keeping them isolated. A single disconnect switch for long or short term storage plus completely isolated circuits and a VSR managing the charge current.

**Battery Isolator Switch**

This option provides the ability to isolate the boat batteries if more than one battery is used. If so equipped, the isolator switch is located behind the front observer's seat under the dash next to the battery. Under normal situations, the switch should be in "POSITION 1" or "POSITION 2" rather than in the "ALL" position. This will keep one battery charged should one of the batteries fail.

**Circuit Breakers and Fuses**

Most electrical standard equipment devices are controlled with circuit breakers. These breakers will activate if overloaded and cut power to the switch. To restore power, simply push the breaker button in and release. Breakers do not require fuse replacement. The breaker panel can be found under the dash next to the 12-V adapter. The stereo, if so equipped, has an inline fuse. If your stereo should quit working, check fuse as well as the breaker.

**12-V DC Accessory Outlets**

All models except Sportster and Flightcraft are equipped with two 12-V DC Accessory Outlets; one on the electrical panel below the dash, and one in the glove box. These outlets provide power from your boat battery to accessory equipment such as cellular phones, video cameras, marine spot lights, etc. Sportster and Flightcraft models do not have the extra glove box outlet.

---

## Miscellaneous

### Hardware

Most of the metal hardware on your boat consists of brass, stainless steel, or aluminum and should be cleaned on a periodic basis with soap and water. In fresh water, metal fittings and hardware should be sprayed annually with a rust inhibitor such as WD-40, and every two or three months in saltwater.

DO NOT use cleaners that are not intended for use on stainless steel. Glass, tile, counter or citrus cleaners can damage hardware permanently. Always follow cleaning, by applying a high-quality metal polish or automotive wax after cleaning. Test products in an inconspicuous area before applying to the complete surface, especially if you are not familiar with the product.

### Bilge

The bilge of your boat can accumulate oil and greasy dirt over a period of time and should be cleaned out periodically. Usually, ordinary soap and water does not remove the accumulation and something stronger will be needed. Check with your Malibu dealer for recommendations.

### Windows and Windshields

The windows and windshields on your Malibu boat are made of tempered safety glass and are similar to the windows in your car. The glass will scratch however, and abrasive cleaners should not be used to clean your windows. Soap and water or automotive glass cleaners may be used.

### Winterizing

When the boating and ski season comes to an end, it is recommended that the boat be removed from the water and stored. It is extremely important that proper winterizing procedures are read and followed to ensure longer boat life. Here is our list of suggestions to keep your boat in top condition:

- Prepare the engine according to the instructions found in your engine owner's manual. It our recommendation that you contact your local Malibu dealer for full winterization procedures.
- Clean and dry the boat interior and exterior thoroughly. Inspect boat hull for residue and remove any if present.
- Clean the bilge area thoroughly and operate the bilge pump to remove any water from bilge lines.
- Remove all seat cushions and open all storage areas. Store the seat cushions in a cool and dry place.
- Cover the boat and store it in a garage or other protected facility.
- If the boat is stored on a trailer, you should block the trailer wheels.

### Storage and Winter Lay-up

Due to the problems that can occur from improper winterization, we recommend that you take your boat to a certified Malibu dealership to perform this task. Without proper preparation, storage for long periods of time may cause parts of the engine and transmission to rust due to lack of lubrication. Also, if your boat will be stored in freezing conditions, water inside these components to include cooling system, heater and shower could result in major damage to your boat. Damage done due to improper winter storage will void your warranty. Here is our list of suggestions to keep your boat in top condition.

---

Prior to boat being removed from water:

- Fill fuel and add 1 ounce of **STA-BIL**<sup>®</sup> fuel stabilizer for each 5 quarts of gasoline.
- Operate boat for at least 15 minutes in water or using a flush system to allow treated fuel to flush engine.
- Add lightweight engine oil (SAE-10 or fogging oil) slowly to the engine while engine is slightly above idle. Turn engine off. Consult your local dealer for correct procedure.

To be completed when boat is put on trailer or resting cradle:

- Remove bilge T-handle and transom drain plug immediately after removing from the water.
- Clean and dry the boat interior and exterior thoroughly. Inspect boat hull for residue and remove if present.
- Clean bilge area thoroughly and operate the bilge pump to remove any water from bilge lines.
- Remove all seat cushions and open all storage areas. Store the seat cushions in a cool dry place.
- Apply coat of wax to entire surface of boat.
- Flush engine-cooling system with clean water. Do not exceed 1500 RPM while flushing for 5-10 minutes.
- Turn fuel supply line to the OFF position (handle perpendicular to fuel line). Perform annual scheduled maintenance. Refer to engine owner's manual for complete engine winterization procedures as well as scheduled maintenance.

**Note:** Damage done due to improper engine winter storage will void your warranty. It is highly suggested that you allow a trained Malibu technician to perform this service.

- After performing engine winterization, remove engine safety switch and spin engine over a few seconds to remove excess water found in pump bodies.
  - Remove the negative cable from battery. Charge battery to fuel charge and remove from boat.
  - Clean all traces of dirt, oil and grease from engine, transmission and bilge. Coat all areas on transmission and engine where paint has been removed with touchup paint.
  - Use duct tape to seal the exhaust flaps closed to prevent dirt and rodents from entering exhaust.
  - Remove propeller assembly, and store in safe place.
  - If your boat is equipped with an optional heater or hot-water shower, remove both hoses and blow through hose to remove excess water.
  - Cover the boat with cover, tarp or, if available, shrink-wrap tarp. Also, due to the excess weight that can occur from rain and snow for boats that are stored outside, it is suggested that you make a support of 2 inch PVC piping that can be mounted under the covering material. The rounded PVC piping will ensure the cover does not tear and will eliminate pooling water inside boat.
-

**Winterization Re-Commission**

- Remove boat cover or shrink-wrap from boat.
- Remove Duct tape from exhaust flaps.
- Charge and install battery in boat. Follow all safety precautions associated with changing batteries.
- De-winterize engine using engine manufacturer's specifications.
- Check propeller shaft alignment. Tighten coupling hardware.
- Check engine compartment for nesting animals. Clean as needed.
- Reinstall seat cushions from storage.
- Check entire engine for signs of cracks caused by freeze damage. Check all hose clamps for tightness. Install bilge drain plugs: transom, T-handle plug and ski locker drain plug.
- Reinstall propeller assembly.
- If not performed during winterization, perform annual maintenance at this time.
- If boat is equipped with optional fresh-water cooling, and was drained at winterization, fill at this time.
- Turn fuel shut-off valve to the On position. (Handle is in line or parallel with the fuel line.) Turn key on and off 2-3 times to allow fuel to return to engine, then start engine. When engine starts, watch gauges closely, and watch for abnormal readings.

## Troubleshooting

The following charts will assist you in finding and correcting minor mechanical and electrical problems with your boat. Problems are listed in the order of the most likely event to the least likely.

To correct a problem, first determine what the problem is. Start with the first cause and eliminate the possibility of each until the problem is corrected. Because of the specialized skills and tools needed to correct major issues, we have not included that information. If you suspect a problem not listed here, please contact your Malibu dealer.

In case of a power supply failure, follow the instructions in *Manually Shift Transmission with Electronic Shift* on page 4-7.

---

PROBLEM	POSSIBLE CAUSE	SOLUTION
Engine will not turn over	<ul style="list-style-type: none"> <li>• Throttle control in gear.</li> <li>• Main circuit breaker open.</li> </ul>	<ul style="list-style-type: none"> <li>• Shift into neutral.</li> <li>• Reset circuit breaker.</li> </ul>
Engine turns over, but will not start	<ul style="list-style-type: none"> <li>• No fuel in tanks.</li> <li>• Contaminated Fuel.</li> <li>• Distributor Problems.</li> </ul>	<ul style="list-style-type: none"> <li>• Fill fuel tank.</li> <li>• See your dealer.</li> <li>• See your dealer.</li> </ul>
Engine is hard to start	<ul style="list-style-type: none"> <li>• Flooded engine.</li> <li>• Plugged flame arrestor.</li> <li>• Fouled spark plugs.</li> <li>• Loose coil or ignition wires.</li> <li>• Battery cables loose or corroded.</li> <li>• Weak battery.</li> <li>• Ignition problems.</li> </ul>	<ul style="list-style-type: none"> <li>• Start engine full throttle and back off.</li> <li>• Clean flame arrestor.</li> <li>• Replace spark plugs.</li> <li>• Tighten coil or ignition wires.</li> <li>• Clean and tighten battery cables.</li> <li>• Charge or replace the battery.</li> <li>• See your dealer.</li> </ul>
Engine misses or idles rough	<ul style="list-style-type: none"> <li>• Fouled spark plugs.</li> <li>• Loose or defective high-tension leads.</li> <li>• Plugged PVC valve.</li> <li>• Weak ignition coil.</li> <li>• Vacuum leak.</li> </ul>	<ul style="list-style-type: none"> <li>• Replace spark plugs.</li> <li>• Tight or replace the high-tension leads.</li> <li>• Replace PVC valve.</li> <li>• Replace ignition coil.</li> <li>• See your dealer.</li> </ul>
Poor boat performance	<ul style="list-style-type: none"> <li>• Fouled spark plugs.</li> <li>• Plugged flame arrestor.</li> <li>• Weak ignition coil.</li> <li>• Contaminated fuel.</li> <li>• Fuel filter clogged.</li> <li>• Ignition problems.</li> </ul>	<ul style="list-style-type: none"> <li>• Replace spark plugs.</li> <li>• Clean the flame arrestor.</li> <li>• Replace the ignition coil.</li> <li>• See your dealer.</li> <li>• See your dealer.</li> <li>• See your dealer.</li> </ul>
Poor gas mileage	<ul style="list-style-type: none"> <li>• Fouled spark plugs.</li> <li>• Plugged flame arrestor.</li> <li>• Inefficient driving habits.</li> <li>• Plugged PCV valve.</li> <li>• Ignition problems.</li> </ul>	<ul style="list-style-type: none"> <li>• Replace spark plugs.</li> <li>• Clean the flame arrestor.</li> <li>• Plan the boat quickly, then slow down to desired speed.</li> <li>• Replace PCV valve.</li> <li>• See your dealer.</li> </ul>



PROBLEM	POSSIBLE CAUSE	SOLUTION
Throttle/shifting problems	<ul style="list-style-type: none"> <li>• Corroded cables.</li> <li>• Defective throttle return spring.</li> <li>• Low transmission oil level.</li>   <li>• Sticking transmission shift detent ball.</li> <li>• Kink in cables.</li> </ul>	<ul style="list-style-type: none"> <li>• Clean and lubricate cables.</li> <li>• Replace the throttle return spring.</li> <li>• Replenish the transmission fluid.</li> <li>• Clean and lubricate detent ball.</li> <li>• Replace the cable(s). See your dealer.</li> </ul>
Steering problems	<ul style="list-style-type: none"> <li>• Corroded cables.</li>   <li>• Rudder worn.</li> </ul>	<ul style="list-style-type: none"> <li>• Clean and lubricate the cable.</li> <li>• See your dealer.</li> </ul>
Excessive vibration.	<ul style="list-style-type: none"> <li>• Damaged propeller.</li> <li>• Misaligned propeller shaft coupling.</li>   <li>• Bent propeller shaft.</li> </ul>	<ul style="list-style-type: none"> <li>• Replace the propeller.</li> <li>• Check the alignment. See your dealer for proper realignment.</li> <li>• See your dealer.</li> </ul>
Electrical problems	<ul style="list-style-type: none"> <li>• Open circuit breaker or blown fuse.</li> <li>• Loose wing connections or corrosion.</li> <li>• Defective sending unit.</li> <li>• Shorted wiring harness.</li> <li>• Defective switch or gauge.</li> </ul>	<ul style="list-style-type: none"> <li>• Reset the circuit breaker or replace the fuse.</li> <li>• Clean and tighten wiring connections.</li> <li>• Replace the sending unit.</li> <li>• Repair the wiring harness.</li> <li>• See your dealer.</li> </ul>
No speedometer	<ul style="list-style-type: none"> <li>• Paddle Wheel.</li> <li>• Defective speedometer.</li> </ul>	<ul style="list-style-type: none"> <li>• Replace the paddle wheel.</li> <li>• Replace the speedometer.</li> </ul>
Incorrect speedometer	<ul style="list-style-type: none"> <li>• Paddle Wheel.</li> <li>• Defective speedometer.</li> </ul>	<ul style="list-style-type: none"> <li>• Replace the paddle wheel</li> <li>• Replace the speedometer.</li> </ul>

## Glossary

AFT:	To the rear of the boat near the stern. Generally used to give directions.
BEAM:	The widest portion of the hull.
BILGE:	The lowest portion inside the boat. This is generally the section directly below the engine compartment.
BOW:	The forward portion of the boat.
BULKHEAD:	Vertical portion in a boat.
CHINE:	The intersection of the sides and bottom of a “V” bottom boat.
DEADRISE:	The degree of angle from the keel to the chine.
DECK:	Upper structure which covers the hull.
DRAFT:	Vertical distance from the waterline of the boat to the lowest part of the boat.
FibECS II:	An engine mounting method, using fiberglass instead of other materials such as aluminum or steel; patented by Malibu Boats LLC. that provides major reduction in noise and vibration.
FIBERGLASS:	Fibers similar to wool or cotton, but made from fibrous glass. Glass fiber forms include cloth, yarn, mat, milled fibers, chopped strands, roving and woven roving.
GELCOAT:	A surface, either colored or clear, providing a cosmetic enhancement and exposure improvements to a fiberglass laminate.
GUNNEL:	The upper edge of a boat’s side.
HELM:	Device attached to rudder for steering a vessel.
HULL:	The bottom section of the boat.
KEEL:	The lowest most portion of the bottom of the boat.
LIFTING STRAKES:	Strips molded or attached to the surface of a hull designed to create lift as speed and pressure increase with the static water.
PORT:	To the left side of the boat, when facing the bow.
STARBOARD:	To the right side of the boat, when facing the bow.
STERN:	To the rear of the boat.
STRINGER:	Longitudinal members that are fastened inside the hull of the boat which provide structural integrity.
TRANSOM:	The area forming the stern, or rear, of a boat.
WAKE:	The track or path a boat leaves behind while in motion.
WORKING DECK	Floor within cockpit or bow area.

## Index

### A

- Adjustable Rudder System . . . . . 3-18
- Anchoring . . . . . 3-16

### B

- Basic Rules Of The Road . . . . . 1-10

### C

- Carbon Monoxide . . . . . 1-9
- Circuit Breakers . . . . . 2-13
- Corrosion Protection . . . . . 3-19

### D

- Docking . . . . . 3-13
- Drain Plugs . . . . . 2-22
- Driver's Seat . . . . . 2-19

### E

- Electrical . . . . . 4-12
- Emergencies . . . . . 1-6
- Emergency Engine Stop Switch . . . . . 2-18
- Engine / Drive Train . . . . . 4-5
- Exhaust . . . . . 2-24
- Exterior . . . . . 4-3

### F

- Fueling . . . . . 3-7
- Fuel System . . . . . 4-11

### G

- General Precautions . . . . . 1-1
- Glossary . . . . . 4-22

### H

- Hazardous Conditions . . . . . 1-7
- High Speed Operation . . . . . 3-14

### I

- Integral Self Draining Ice Chest . . . . . 2-19
- Interior . . . . . 4-1

### M

- Miscellaneous . . . . . 4-16
- Motorbox Cover . . . . . 2-18

### N

- Navigational Lights . . . . . 2-21

### O

- Operation by Minors . . . . . 1-10
- Optional Equipment . . . . . 2-26

### P

- Passenger Safety . . . . . 1-10
- Power Wedge . . . . . 2-11
- Propellers . . . . . 3-17

### R

- Regulations . . . . . 1-3
- Responsibilities . . . . . 1-3

### S

- Safety Statements . . . . . 1-1
- Shifting / Running . . . . . 3-10
- Ski Pylon . . . . . 2-20
- Speedometer Pick-Up . . . . . 2-23
- Standard Gauges . . . . . 2-1
- Starting . . . . . 3-8
- Steering . . . . . 3-10
- Steering System . . . . . 2-18
- Stopping . . . . . 3-12
- Storage Areas . . . . . 2-22
- Sundeck . . . . . 2-20
- Swim Platform . . . . . 2-21
- Switches & Indicators . . . . . 2-13

### T

- Throttle Control . . . . . 2-17
- Tilt Steering Wheel . . . . . 2-23
- Towing A Skier . . . . . 3-14
- Towing Another Boat . . . . . 3-16
- Trailer . . . . . 3-1
- Trailer . . . . . 3-1
- Troubleshooting . . . . . 4-19

### V

- V-Drive Engine Access Hatch . . . . . 2-20
- Ventilation . . . . . 2-25

### W

- Warning Labels . . . . . 3-4
- Wedge . . . . . 2-32



# Maintenance Worksheet

Please circle one- Pre-delivery-/10hr.-/50hr.-/100hr.-/Annual

HULL NUMBER	OWNER NAME	PHONE NO.	
<b>SERVICE DATE</b>  <b>INSTRUCTIONS</b> Please complete following; check each item as completed.	<b>WORK ORDER #</b>  1. Inspect prop 2. Check engine alignment, motor mounts, and jam nuts 3. Check shaft packing 4. Service rudder (lubrication) 5. Check battery, battery hold down, cable connections 6. Check instrumentation 7. Check lights (bow, stern, and dash) 8. Check steering wheel cable fasteners, lubricate support tube and cable 9. Check control mechanism MV-2, MV-3 (freedom of movement) 10. Check neutral safety switch operation 11. Check security of fasteners (seat slides, seats, platform, interior handles) 12. Check all fuel connections (engine, tank, pump, filter) 13. Check engine exhaust clamps 14. Change engine oil and filter 15. Change transmission fluid/ filter 16. Change V-Drive oil (clean screens / magnetic plugs) 17. Inspect belts 18. Inspect impeller 19. Clean / change flame arrestor 20. Check engine coolant (closed cooling only) 21. Check trailer: wheel lugs, lights, and loading bar 22. Inspect and lubricate wheel bearings 23. Check brake fluid level (if applicable)	<b>BOAT COLOR</b>  <b>LAKE TEST</b> 1. Perform Diacom data list scan 2. Check PROM ID and record in customer file 3. Check fuel pressure and log reading 4. Verify oil levels (engine, Trans, V-Drive) 5. Verify blower operation, check hose attachment 6. Verify bilge pump operation and float control 7. Check for engine / boat water leaks 8. RE-check fuel connections 9. Verify neutral safety switch operation 10. Check for presence of vibration 11. Verify instruments operate properly 12. Verify controls operate properly (IE; steering, shifter) 13. Verify options function properly (IE; heater, shower etc.)	<b>SERVICE TECHNICIAN</b>

I certify that all checks have been performed and completed, this vessel has been prepared in conjunction with Malibu Boats specifications. To ensure proper warranty status, Boat/ Engine MUST receive recommended maintenance schedule.

Technician Signature \_\_\_\_\_ Date \_\_\_\_\_  
 Service Contact \_\_\_\_\_ Phone \_\_\_\_\_

Customer Signature \_\_\_\_\_  
**PLEASE RETAIN IN CUSTOMER FILE FOR FUTURE REFERENCE**

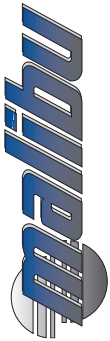

## Required Maintenance Schedule Indmar Engines

Item No.	Service	First 10 hours	Every 50 hours	Every 100 hours	Annually
1.	<b>Change engine oil and filter</b> Pennzoil Marine 15W40, Pennz #PZ-3, AC PF-25	***	***		***
2.	<b>Change transmission oil and filter</b> Dextron III w/Mercon				***
3.	<b>Ski Vee</b> ATF				***
4.	<b>Change fuel filter, Motor / Gas tank</b>				***
5.	<b>Change Spark plugs</b> Indmar Engines MUST use AC-MR43LTS or 41-932 Platinum				***
6.	<b>Engine tune up</b> (Cap, Rotor, Plugs)				***
7.	<b>Clean for change flame arrestor</b>			***	
8.	<b>Inspect belts, hoses and clamps</b> Tight?	***			***
9.	<b>Shaft alignment</b> Within .003	***			***
10.	<b>Inspect spark plug wires</b>				***
11.	<b>Inspect Raw water pump impeller</b> (change annually)			***	***
12.	<b>Inspect rudder</b> (lube, key-way, bolt tight)		***		***
13.	<b>Inspect Prop Shaft Packing</b>	***			**
14.	<b>Inspect Steering Kit Assembly</b> (Lube, bolts tight?)		***		***
15.	<b>Check Engine Coolant (closed cooling only)</b> 50:50 mix water w/ethylene glycol MUST meet GM 6038				***
16.	<b>Propeller Tight</b> (prop nut tight? key-way installed?)	***	***	***	***7
17.	<b>Lubricate starter bendix ( Lithium marine grease )</b>		***		***





There's Something Special Here.

**Corporate Headquarters**

Malibu Boats, L.L.C.  
One Malibu Court  
Merced, CA 95341  
Phone: (209) 383-7469  
Fax: (209) 383-0499

**Tennessee Plant**

Malibu Boats, L.L.C.  
5075 Kimberly Way  
Loudon, TN 37774  
Phone: (865) 458-5478  
Fax: (865) 458-9052

**Australian Headquarters**

Malibu Boats, L.L.C.  
813 Hope Court  
Albury, N.S.W. 2640  
Phone: (026) 040-1174  
Fax: (026) 040-4656

website: [www.malibuboats.com](http://www.malibuboats.com) email: [info@malibuboats.com](mailto:info@malibuboats.com)

