

2004

Owners Manual

MasterCraft ProStar, MariStar and X-Series

Welcome Aboard

Congratulations on your choice of the finest ski boat available! MasterCraft is the recognized world leader for in-board ski boats today and has been for more than 35 consecutive years. The quality, innovation, selection and value are unmatched in the industry.

Please take a few minutes to read this manual completely before the use of your MasterCraft boat for the first time. It will help you answer most of the remaining questions you may have about your new boat. If you still have questions after reviewing this manual, be sure to contact your MasterCraft dealer. It is important for you to approach your boating experience with confidence and as much knowledge as you can.

Every effort has been made to make this manual accurate. All information is based on the latest product information available at the time of printing. Because of our policy of continuous product improvement, we reserve the right to make changes in specifications and models at any time, without notice, and also to discontinue models. The right is also reserved to change specifications, parts or accessories at any time without incurring any obligation to equip the same on models manufactured before the date of the change. The continuing accuracy of this manual cannot be guaranteed. The illustrations used in this manual are intended only as representative reference views and may not depict actual model component parts. Information about certain on-board components furnished by suppliers other than MasterCraft is provided separately. This information is available from your dealer.

Note: The information given in this manual may not be applicable to international waterway rules. If you have any questions, please contact your local authority.

Visit us on the web at www.mastercraft.com. If you have specific questions about your MasterCraft boat or trailer, feel free to contact your dealer for additional information and guidance.

MasterCraft Boat Company, 100 Cherokee Cove Drive, Vonore TN 37885

The maintenance, service and repair procedures described in this Manual should be performed only by trained and authorized factory personnel or dealer technicians. To avoid serious injury or damage to the boat or its components, all steps in each procedure and all safety recommendations should be strictly observed. Failure to follow the procedures described will void any and all warranties and may cause personal injury or damage to components and adversely affect the operation of the boat. CONSUMERS SHOULD NEVER ATTEMPT TO UNDERTAKE THE MAINTENANCE AND REPAIR PROCEDURES DESCRIBED IN THIS MANUAL.

Dangers, Warnings and Cautions

Throughout this manual the terms “danger,” “warning” and “caution” appear, alerting the boat owner or operator to dangerous or potentially dangerous situations that may arise. Those terms have the following respective meanings whenever they appear herein:



This is the safety alert symbol. It is used to alert you to potential personal injury hazards. Obey all safety messages that follow this symbol to avoid possible injury or death.



DANGER indicates an imminently hazardous situation which, if not avoided, will result in death or serious injury.



WARNING indicates a potentially hazardous situation which, if not avoided, could result in death or serious injury.



CAUTION indicates a potentially hazardous situation which, if not avoided, may result in minor or moderate injury.



CAUTION used without the safety alert symbol indicates a potentially hazardous situation which, if not avoided, may result in property damage.

Failure to adhere to and comply with the safety dangers, warnings and cautions that appear in this manual can lead to serious illness, injury or even death and/or damage to your boat or the property of others. Beyond these warnings, boaters have a personal responsibility to utilize a common sense approach to the boating experience, including keeping individuals off or near the swim platform and the stern area of the boat during the engine operation. Personal flotation devices (“PFDs”) save lives and ensure positive experiences. MasterCraft offers many proactive approaches to the boating experience, but the consumer is ultimately responsible for a positive and safe involvement in boating.

Be sure to review the **Boating Safety** section of this manual, which immediately follows this section. Because of the importance of these dangers, warnings and cautions, they are reprinted here, along with the pages on which you’ll find them. Please note that the safety information statements presented below are categorized for information purposes only, and are not presented in any particular order of importance. Each of the statements referenced below and in the other sections of this manual provide you with important safety-related information and must be read and followed to avoid injury or damage, as applicable. We strongly encourage your to cross-reference and read the dangers, warnings and cautions within the context in which they are presented by reading and reviewing those sections.



DANGER indicates an imminently hazardous situation which, if not avoided, will result in death or serious injury.

- I: Failure to comply with safety-related information and instruction may result in serious injury or death to you and/or others. Always use common sense when operating the boat or participating in any activities associated with the boat. (Page 1-3)

- 2: Gasoline is highly flammable and its vapors may ignite resulting in fire or explosion. Be sure to keep all sparks and flames well away from the area while inspecting the boat's fuel system. (Page 17-7)
- 3: Gasoline is explosive. If you see or smell the presence of gasoline during your inspection, **DO NOT START YOUR ENGINE!** Remove your ignition key from the ignition switch and call your MasterCraft dealer for service. (Page 19-8)
- 4: Gasoline is extremely flammable and highly explosive under certain conditions. Always stop the engine and never smoke or allow open flames or sparks within 50 feet of the fueling area when refueling. (Page 8-2)
- 5: Take care not to spill gasoline. If gasoline is spilled accidentally, wipe up all traces of it with dry rags immediately and properly on shore. (Page 8-2)
- 6: Failure to operate the blower as instructed could cause improper ventilation of the boat engine and bilge areas. Fuel vapors can accumulate in this area and cause a fire or explosion which may result in serious injury or death! (Page 7-3)
- 7: To prevent a possible explosion, operate the blower for at least four (4) minutes before starting the engine and always when at idle or slow-running speed. Explosive gasoline and/or battery fumes may be present in the engine compartment. Failure to do so may result in serious injury or death! (Page 11-1)
- 8: Carbon monoxide is a colorless, tasteless, odorless and poisonous gas that accumulates rapidly and can cause serious injury or death. Exposure to carbon monoxide can be fatal in a matter of minutes. Exposure to even low concentrations of carbon monoxide must not be ignored because the effects of exposure to carbon monoxide are cumulative and can be just as lethal as at high concentrations. Carbon monoxide from exhaust pipes of inboard or outboard engines may build up inside and outside the boat in areas near exhaust vents. **STAY AWAY** from these exhaust vent areas, which are located at the stern of the boat, and **DO NOT** swim or engage in any watersports or other activities in or near the stern area of the boat, including, without limitation, the swim platform and the rear sun deck, when the engine is in operation. Under no circumstances should "teak surfing" or similar activities be performed during the operation of your MasterCraft boat—such activities are a misuse of this product. (Page 24-1)
- 9: The safety switch lanyard must be attached to the operator whenever the engine is started. Failure to do so may result in serious injury or death. (Page 7-3)
- 10: Never override or modify the engine safety shut-off switch or engine neutral starting safety switch in any way. (Page 1-3)
- 11: Before starting the engine, open the engine compartment and check for gasoline fumes, fuel and oil leaks or the presence of fuel or oil in the bilge. (Page 11-1)



WARNING indicates a potentially hazardous situation which, if not avoided, could result in death or serious injury.

- I: **DO NOT** launch or operate the boat if any problem is found during the Safety Check. A problem could lead to an accident during the outing, resulting in serious injury or death. Any and all problems should receive attention immediately. See your MasterCraft dealer for assistance. (Page 9-1)

- 2:** Running the engine with the flame arrestor removed increases the possibility of fire or explosion if the engine should backfire and gasoline fumes are present. If the engine is operated without the flame arrestor secured, extreme care must be taken to ensure that the engine compartment is well-ventilated and that no fuel leaks are present. *(Page 21-2)*
- 3:** Battery electrolyte fluid is dangerous. It contains sulfuric acid, which is poisonous, corrosive and caustic. If electrolyte is spilled or placed on any part of the human body, immediately flush the area with large amounts of clean water and seek medical aid. *(Page 17-3)*
- 4:** When charging, batteries generate small amounts of dangerous hydrogen gas. This gas is highly explosive. Keep all sparks, flames and smoking well away from the area. Failure to follow instructions when charging a battery can cause an electrical charge or even an explosion of the battery which could cause serious injury or death. *(Pages 17-3 and 17-9)*
- 5:** The engine box serves as a machinery guard. The engine must be OFF whenever the box is open. Clothing or body parts can get caught in moving parts, causing serious injury or death. Keep away from moving parts! *(Pages 17-6, 17-7, 17-8)*
- 6:** Before towing this trailer, be sure to read and familiarize yourself with this section of your manual. *(Page 26-2)*
- 7:** The total weight of your boat, engine, fuel, water and gear must not exceed the trailer's maximum load-carrying capacity. Overloading can cause serious injury or property damage. Note: Maximum load-carrying capacity is the Gross Vehicle Weight Rate ("GVWR") less the weight of the empty trailer. *(Page 26-2)*
- 8:** Trying to tow with water-filled bladder(s) may not only cause the total weight limits for the trailer to be exceeded but may also result in the improper distribution of the weight on the trailer thereby making towing difficult and/or causing instability when towing, which can be very dangerous to you and to other motorists. You should NEVER tow with water in the ballast bladders or tanks! *(Page 26-2)*
- 9:** Serious injury or death or property damage can result if the total weight on your loaded trailer exceeds the capacity of the hitch on your tow vehicle. *(Page 26-3)*
- 10:** Failure to properly attach the safety cables between your trailer and the tow vehicle can result in a runaway trailer if the trailer coupler becomes detached from the hitch, which may cause serious injury or death or property damage. *(Page 26-4)*
- 11:** Failure to properly engage the hitch ball in the coupler ball socket and to securely lock the coupler latch mechanism can cause the trailer to become detached from the tow vehicle while traveling, which may cause serious injury or death or property damage. *(Page 26-5)*
- 12:** To reduce the risk of serious injury, death or property damage, make certain that all the trailer lights are in proper working order. *(Page 26-5)*
- 13:** Maintain the proper torque on the lug nuts attached to the wheel bolts. Failure to do so may result in serious injury or property damage. Your MasterCraft dealer can provide you with the proper torque specifications (measured in foot-pounds). *(Page 26-5)*
- 14:** Also keep the wheel bearings lubricated. Failure to do so may cause failure and possible wheel loss, which may result in serious injury or death or property damage. *(Page 26-6)*

- 15:** Keep your tires properly inflated. Failure to maintain the correct pressure may result in tire failure and loss of control, which may result in serious injury or death or property damage. *(Page 26-7)*
- 16:** Trailer brakes must be maintained in good working condition. The loss of adequate braking could result in serious injury or death or property damage. *(Page 26-7)*
- 17:** Adding additional ballast to your MasterCraft boat is not recommended, and can result in impaired visibility, diminished handling characteristics and instability when operating your boat, and may result in potential structural and/or engine damage to your boat, which damage will not be covered by your warranty. *(Page ____)*
- 18:** Use of improper parts can cause component or engine failure, which may result in serious injury or death! *(Page 14-1)*
- 19:** Do not tow boat with wakeboards or skis left in board and/or ski racks. Doing so may create a hazard for or cause damage to vehicles following behind you as the boards and/or skis may become disengaged while traveling, or may result in damage to your vehicle or boat, which damage would not be covered by your warranty. *(Page ____)*



CAUTION indicates a potentially hazardous situation which, if not avoided, may result in minor or moderate injury.

- 1:** Some launch ramps may be slippery when wet. Use great care when walking, standing or loading and unloading boats on or around any launch ramps. *(Page 26-10)*
- 2:** Wet brakes may not hold and/or may cause brakes to have diminished performance characteristics. A few braking applications at a slow speed will help to dry them out, but extra care must be used when braking after brakes have become wet. *(Page 26-10)*
- 3:** Be sure that all fasteners you use are approved and rated for marine use. Most fasteners used on MasterCraft boats are stainless steel or specially coated to resist corrosion. *(Page 14-1)*
- 4:** All replaced fuel system components must meet United States Coast Guard (“USCG”) and American Boat & Yacht Council, Inc. (“ABYC”) standards, and must be Underwriter’s Laboratory (“UL”)-approved. Inferior quality components pose a serious safety threat to you and others, and the use of inferior components may result in serious injury or death. Resulting damage may void your warranty. *(Page 19-8)*
- 5:** The use of an unapproved ski pylon extension or extensions is not recommended by MasterCraft on our products. If you elect to use unapproved merchandise, be aware that these items could create excessive stress on your boat and could result in damages not covered by your warranty! *(Page 1-3)*
- 6:** Continuing to operate the boat while the temperature is above normal operating parameters may cause serious damage to your engine. Damage to your engine resulting from operating the engine in an overheated condition can be costly to repair. Such damage is not covered by your warranty! *(Page 7-2)*
- 7:** Do not continue to run the engine if the oil pressure is low. If you do, the engine can become so hot that it—or surrounding components—could catch fire. Your or others could be burned and the boat seriously damaged. Check your oil level and add an appropriate amount of approved motor oil before

operating again or have your boat serviced by your local MasterCraft dealer. Note that damage to your engine from neglected oil problems can be costly to repair. Such damage is not covered by your warranty. (Page 7-2)

CAUTION

CAUTION used without the safety alert symbol indicates a potentially hazardous situation which, if not avoided, may result in property damage.

- 1:** To ensure proper break-in and lubrication, boat owners should not remove the factory break-in oil until after the initial ten (10) hours of operation. At that time, an oil change should be performed by an authorized MasterCraft service technician/your local MasterCraft dealer. (Page 10-1)
- 2:** DO NOT use the ski pylon for lifting. It is NOT designed as a central lifting point. Also, DO NOT use the stern ski tow as a lifting ring. The deck will be damaged. See the *Storage Cradle* sub-section of the **Lifting the Boat** section of this Manual. Also never lift a boat with a large amount of water in the bilge or containing a water-filled device such as a Fat Sac or ballast system. The extra stress will put an excessive load on the hull and lifting equipment that may seriously damage the boat and void your warranty. (Page 13-1)
- 3:** Continued operation after the warning light has illuminated may cause severe engine damage. This will void your warranty. (Page 11-3)
- 4:** Because of the complexity of preparing your boat for proper winter storage, as well as the possibility of extreme damage to the engine if a preparation error was made during winterization, MasterCraft recommends that you schedule an appointment with your local MasterCraft dealer and permit the dealer to perform the winterization procedures. (Page 21-1)
- 5:** Add-on equipment may adversely affect the alternator output or overload the electrical system. Any damage caused as a result will not be covered by, and may void, your warranty. (Page 17-3)
- 6:** Ignoring elevated temperatures on a temperature gauge or any other evidence of the engine operating at temperatures above recommended levels can result in serious damage to the engine. Any resulting damage will not be covered by, and may void, your warranty! (Page 17-5)
- 7:** Failure to follow the engine oil recommendation listed in the manual can cause additional engine wear and increase the possibility of engine component failure. Damage to your engine due to incorrect oil usage can be costly to repair, and is not covered by your warranty! (Pages 10-2 and 18-3)
- 8:** Failure to maintain your coolant at the proper level can cause engine damage. Your warranty will not cover engine damage due to overheating or any other cause associated with improper coolant levels. (Page 17-2)
- 9:** Do not operate the starter motor continuously for more than fifteen (15) seconds without at least a two (2) minute “cool-down” period. Failure to do so may cause the starter to overheat, resulting in damage. Failure to release the ignition key after the engine has started may cause damage to the starter motor and drive. (Page 11-2)
- 10:** Damage to the engine by use of low-quality gasoline or gasoline with an octane rating below the minimum level listed will void the warranty on your boat. (Page 8-1)
- 11:** Fuels that are blended to contain methanol or wood alcohol are not to be used in MasterCraft engines. These fuels can corrode some metal parts in your fuel system and engine. Damage caused by the use of unapproved fuels is not covered by warranty. (Page 8-2)

- 12:** Extended storage with fuel in the system can affect the fuel's stability and may require system inspection and fuel filter replacement when the unit is placed back into service. *(Page 8-2)*
- 13:** Lifting slings must never contact shafts, struts or hardware protruding from the hull. Damage caused by slings will void your warranty. *(Page 13-1)*
- 14:** When your boat is out of the water, it is important to support the hull correctly to avoid any hull damage that will void your warranty. *(Page 13-1)*
- 15:** Crossing cables or jumper cables can result in damage to the electrical components due to incorrect battery connections. Such damages are not covered by your warranty. *(Page 17-4)*
- 16:** Attention must be paid to any leakage occurring in the propeller shaft log area. Water intrusion into the transmission, which can happen if excessive leakage is occurring, can cause serious damage and void your warranty. *(Page 17-7)*

Table of Contents

BOATING SAFETY -----	1-1	INSPECT EXHAUST FLAPS -----	19-5
RULES OF THE OPEN WATER -----	2-2	LUBRICATE STEERING SYSTEM -----	19-5
NAUTICAL TERMINOLOGY -----	3-2	LUBRICATE SHIFT AND THROTTLE SYSTEM -----	19-6
MASTERCRAFT DESIGN PROCESS -----	4-1	BALLAST PUMP IMPELLER -----	19-7
INDIVIDUAL MODELS -----	5-1	INSPECT COMPLETE FUEL SYSTEM FOR LEAKAGE -----	19-7
PROSTAR 190 -----	5-2	EMISSIONS -----	20-1
PROSTAR 197 -----	5-3	STORAGE/WINTERIZATION -----	21-1
PROSTAR 209 -----	5-4	GENERAL PREPARATION -----	21-1
PROSTAR 205 V-DRIVE -----	5-5	FUEL SYSTEM TREATMENT -----	21-1
MARISTAR 210 -----	5-6	ALL ENGINES -----	21-2
MARISTAR 230 -----	5-7	RAW-WATER COOLED ENGINES -----	21-2
MARISTAR 280 -----	5-8	FRESH-WATER COOLED ENGINES -----	21-3
X-2 -----	5-9	DRIVE TRAIN PREPARATION -----	21-3
X-7 -----	5-10	GENERAL POWER PACKAGE PREPARATION -----	21-3
X-9 -----	5-11	OTHER WINTERIZATION PREPARATION -----	21-3
X-10 -----	5-12	BALLAST SYSTEM PREPARATIONS -----	21-4
X-30 -----	5-13	REACTIVATING AFTER STORAGE -----	21-4
X-Star -----	5-14	UNSCEDULED MAINTENANCE	
ENGINE & PROPELLER SPECIFICATIONS -----	6-1	CHECKING/REPAIRING PROPELLERS -----	22-1
CONTROLS AND INDICATORS -----	7-1	CHANGING PROPELLERS -----	22-1
FUELING -----	8-1	CHECKING SPEEDOMETER CALIBRATION -----	22-1
SAFETY CHECKS AND SERVICES -----	9-1	TROUBLESHOOTING -----	23-1
NEW BOAT BREAK-IN -----	10-1	THE COMMON SENSE APPROACH -----	24-1
STARTING AND BASIC OPERATIONS -----	11-1	LIMITED WARRANTY STATEMENT -----	25-1
OPERATIONAL HINTS -----	12-1	MASTERCRAFT TRAILERS	
LIFTING THE BOAT -----	13-1	TRAILERING AND LAUNCHING -----	26-1
CORROSION -----	14-1	A PROPER MATCH -----	26-2
CLEANING -----	15-1	LOAD-CARRYING CAPACITY -----	26-2
SCHEDULED MAINTENANCE CHECKS & SERVICES ---	16-1	WEIGHT DISTRIBUTION -----	26-2
BEFORE EACH USE		TRAILER HITCH -----	26-2
TRANSMISSION COOLER -----	17-1	SAFETY CABLES -----	26-3
COOLANT LEVEL -----	17-1	TRAILER WINCH ASSEMBLY -----	26-4
ALTERNATOR BELT -----	17-2	WARNINGS ON PIVOT TONGUE -----	26-4
BATTERY CONNECTIONS AND HOLD-DOWNS -----	17-3	MASTER CYLINDER LEVEL -----	26-4
LOOSE OR MISSING HARDWARE -----	17-4	TRAILER COUPLING -----	26-4
CABLE KINKS, WEAR AND INTERFERENCE -----	17-4	LIGHTS -----	26-5
IMPELLER -----	17-5	WHEELS AND HUBS -----	26-5
PROPELLER SHAFT LOG -----	17-6	LUG NUTS OR WHEEL BOLTS -----	26-6
FUEL SYTEM LEAKS -----	17-7	LUBRICATION -----	26-6
EXHAUST SYSTEM LEAKS -----	17-8	WHEEL BEARINGS AND BRAKING SYSTEM -----	26-7
FULLY CHARGED BATTERY -----	17-9	TIRES -----	26-7
ENGINE OIL LEVEL -----	17-9	BRAKES -----	26-7
TRANSMISSION FLUID LEVEL -----	17-10	TRAILER JACKS -----	26-8
QUARTERLY MAINTENANCE		TIE-DOWNS -----	26-8
ENGINE STARTER GEAR AND SHAFT LUBRICATION -----	18-1	HITCHING UP -----	26-8
CHANGE ENGINE OIL -----	18-1	TRAILER TECHNIQUES -----	26-9
ANNUAL MAINTENANCE		LAUNCHING -----	26-10
CLEAN ENGINE FLAME ARRESTOR -----	19-1	STORAGE -----	26-10
REPLACE RAW WATER PUMP IMPELLER -----	19-3	TRAILERING TIPS -----	26-11
ENGINE TUNE-UP -----	19-3	TRAILERING CHECKLIST -----	26-11
CHANGE TRANSMISSION FLUID -----	19-3	GMP PRODUCTS -----	27-1
CHECK ENGINE MOUNTS -----	19-4	WARRANTY TRANSFER -----	28-1
CHECK PROPELLER SHAFT COUPLING ALIGNMENT -----	19-5	TEAM MASTERCRAFT -----	29-1

Boating Safety

Your safety, as well as the safety of others with and around you, is a direct result of how you operate and maintain your boat. Read and comprehend this manual. Make sure that you understand all the controls and operating instructions before attempting to operate the boat. **Improper operation is extremely dangerous!**

The basic safety rules are outlined in this section of the manual. Additional precautions throughout the manual are noted by the following symbols:



This is the safety alert symbol. It is used to alert you to potential personal injury hazards. Obey all safety messages that follow this symbol to avoid possible injury or death.



DANGER indicates an imminently hazardous situation which, if not avoided, will result in death or serious injury.



WARNING indicates a potentially hazardous situation which, if not avoided, could result in death or serious injury.



CAUTION indicates a potentially hazardous situation which, if not avoided, may result in minor or moderate injury.



CAUTION used without the safety alert symbol indicates a potentially hazardous situation which, if not avoided, may result in property damage.

The precautions listed in this manual and on the boat are not all-inclusive. If a procedure, method, tool or part is not specifically recommended by MasterCraft, using it may place you and others in an unsafe situation; as well, you may render your warranty void. *Remember: Always use common sense when operating, servicing or repairing the boat!*

In addition to everyday safety, failure to observe the safety recommendations may result in severe personal injury or death to you or to others. Use caution and common sense when operating your boat. **Don't take unnecessary chances!**

Be certain that all boat operators are aware of this information and conform to boat safety principles.

General Precautions

Boating safety starts with a thorough understanding of operation. In addition to careful review of this manual, you should be aware as well that there are many sources of information available. MasterCraft urges you to pursue additional training.

The following is a listing of just some of the agencies and organizations that offer safety training or information.

AMERICAN RED CROSS, NATIONAL HQ
8111 GATEHOUSE ROAD, 6TH FLOOR
FALLS CHURCH VA 22042
(202) 737-8300
www.redcross.org

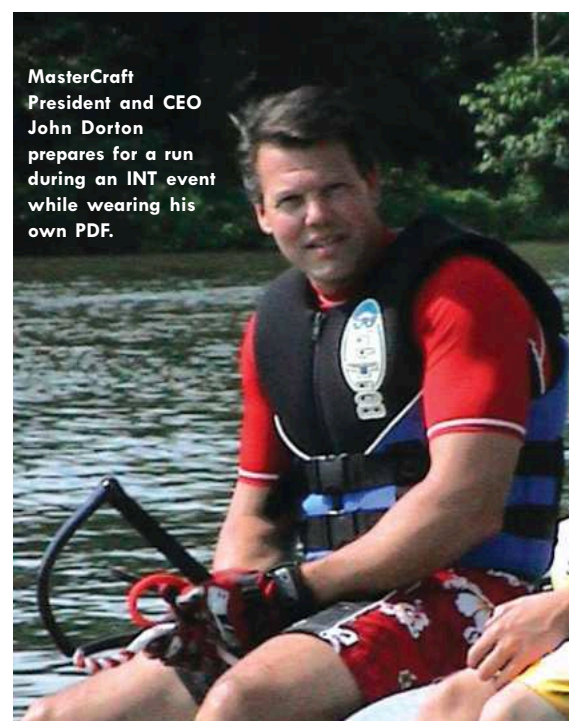

MasterCraft
President and CEO
John Dorton
prepares for a run
during an INT event
while wearing his
own PDF.



USA WATER SKI ASSOCIATION
1251 HOLY COW ROAD
POLK CITY FL 33868
(863) 324-4341
<http://usawaterski.org>

BOAT OWNERS ASSOCIATION OF THE UNITED STATES
880 SOUTH PICKETT STREET
ALEXANDRIA VA 22304
(703) 823-9550
<http://boatus.com>

NATIONAL SAFE BOATING COUNCIL
2550 M STREET NW, SUITE 425
WASHINGTON DC 20037
(202) 296-4588
www.safeboatingcouncil.org

U.S. COAST GUARD AUXILIARY
2100 SECOND STREET SW
WASHINGTON DC 20593-0001
(202) 267-1001
<http://uscg.mil>

Safety Equipment

Federal law requires certain safety equipment to be on-board at all times. In addition, responsible boaters carry other equipment in case of emergency. Check with the local boating authorities for any additional requirements over and above the federal stipulations.

Required Equipment

Your MasterCraft has been equipped at the factory with most of the federally required safety equipment for inland waters (Class I, 16-foot-to-26-foot watercraft). This equipment includes:

- ABYC-approved marine mufflers with water injection
- USCG-approved marine flame arrestor
- USCG-approved engine box ventilation with spark-less power blower
- ABYC-approved electric horn sound-warning device
- USCG-approved inland lighting.

Federal law also requires at least one Type I, II or III Personal

Flotation Device (PFD) for each person on-board or being towed on water skis or other recreational equipment. In addition, one throwable Type IV PFD must also be on board. As the owner, obtaining the appropriate PFDs is your responsibility. Your MasterCraft dealer can—and will be—happy to assist you.

Note: Requirements for coastal waters and inland waters differ. Check with the local authorities for more information.

Recommended Equipment

A smart boat owner will avoid potential problems on an outing by having additional equipment on board. Normally, the decision regarding which equipment to take is dependent on the body of water and the length of the trip. We suggest the following as a minimum. Your MasterCraft dealer can also assist you with additional recommendations.

- An anchor with at least 75 feet of line
- A manual bailing device for removing water
- A combination oar/boat hook
- A day-and-night visual distress signal

- A first aid kit and manual
- An airway breathing tube
- A waterproof flashlight
- A horn or whistle, non-electric
- A set of local navigational charts
- Mooring lines and fenders
- Extra engine oil
- A tool kit
- A portable, battery-operated AM/FM radio

Safety Aloft

Boating-related accidents are generally caused by the operator's failure to follow basic safety rules or written precautions. Most accidents can be avoided if the operator is completely familiar with the boat, its operation, and can recognize potentially hazardous situations before an accident occurs.

- Never allow any type of spark or open flame on board. It may result in fire or explosion.
- Prior to starting the engine, you must open the engine box and check the engine compartment and bilge for gasoline and oil vapors. You must also operate the blower for at least four minutes. Failure to do so may result in fire or explosion.
- Never remove or modify any components of the fuel systems, except for maintenance and repair performed by qualified MasterCraft personnel. Tampering with fuel components may cause a hazardous situation and voids warranty.
- Never allow any type of spark or open flame on board. It may result in fire or explosion.



Failure to comply with safety-related information and instruction may result in serious injury or death to you and/or others. Always use common sense when operating the boat or participating in any activities associated with the boat.

- Improper operation is extremely dangerous. Operators must read and understand all operating manuals supplied with the boat, before operation.
- On-board equipment must always conform to the governing federal, state and local regulations.
- Always attach the engine safety shut-off lanyard to a part of your clothing, such as a belt loop, when operating the boat.

Skiing & Wakeboarding Safety

Skiers and wakeboarders are obligated to be as aware of the fundamental safety rules as operators must be. If you are new to water skiing, seek certified training before starting. You will find it especially helpful to join a local ski club and the USWSA, when possible.



Never override or modify the engine safety shut-off switch or engine neutral starting safety switch in any way.

- Never operate the boat while under the influence of alcohol or drugs.
- Never stand or allow passengers to stand in the boat—or sit on the motor box—while underway. You or others may be thrown from the boat.
- Prior to starting the engine, you must open the engine box and check the engine compartment and bilge for gasoline and oil vapors. You must also operate the blower for at least four minutes. Failure to do so may result in fire or explosion.
- Never remove or modify any components of the fuel systems, except for maintenance and repair performed by qualified MasterCraft personnel. Tampering with fuel components may cause a hazardous situation and voids warranty.

Always remember that the majority of water-skiing and wakeboarding injuries are the result of impacts with other objects, so always look where you are going and be aware of what is going on around you.

Never put your arm, head or any other part of your body through the handle/bridle of the ski line nor wrap the line around any part of the body at any time.

- **Never ski at night, or directly in front of other boats.**
- **Never jump from a boat that is moving at any speed, nor enter or exit the water when the engine is running (ON).**

**CAUTION**

The use of an unapproved ski pylon extension or extensions is not recommended by MasterCraft on our products. If you elect to use unapproved merchandise, be aware that these items could create excessive stress on your boat and could result in damages not covered by your warranty!

- Make sure that everyone knows and uses approved skiing hand signals and common skiing courtesy.
- Never ride on the ski platform or hold on to the platform while in the water during engine operation, including at idle. Carbon monoxide fumes are expelled from the lower transom area of a boat and can cause serious illness or even death.
- The above recommendations are not all-inclusive. It is the boater's responsibility to operate the boat in a safe fashion and become familiar with any and all rules and laws governing boat operation.

Warning Plates and Labels

Read and note ALL warning plates and labels from bow to stern! **YOU MUST READ AND ADHERE TO ALL CAUTIONS AND WARNINGS IN AND ON YOUR BOAT!**



Rules of the Open Water

Just as there are rules that apply when driving a vehicle on the street, there are waterway rules that apply when you are driving a boat. These rules are used internationally, and they are enforced by the United States Coast Guard and local agencies. You should be aware of these rules and follow them whenever you encounter another vessel on the water.



In various geographic locations certain rules prevail that may be unique to the locale, but all are basically the same as the International Rules of the Road.

The rules presented in this manual are condensed and have been provided as a convenience only. Consult your local U.S. Coast Guard Auxiliary (USCGA), Department of Motor Vehicles (DMV) or Department of Natural Resources (DNR) for a complete set of rules governing the waters in which you will be using your boat. If you plan to travel—even for a short trip—you would be well-served to contact the regional USCGA, DMV or DNR in the area where you will be boating.

Steering and Sailing Rules/Sound Signals

Any time two vessels on the water meet one another, one vessel has the right-of-way. It is called the **stand-on vessel**. The vessel that does not have the right-of-way is called the **give-way** or **burdened vessel**.

These rules determine which vessel has the right of way, and accordingly, what each vessel should do.

The vessel with the right-of-way has the duty to continue its course and speed, except to avoid an immediate collision. When you maintain your direction and speed, the other vessel will be able to determine how best to avoid you.

The vessel that does not have the right-of-way has the duty to take positive and timely action to stay out of the way of the stand-on vessel. Normally, the give-way vessel should not cross in front of the stand-on vessel. Slow down or change directions briefly and pass behind the other vessel. You should always move in such a way that the stand-on operator can see what you are doing.

The General Prudential Rule

This rule is called Rule 2 in the International Rules and says,

“In obeying and construing these rules due regard shall be had to all dangers of navigation and collision, and to any special circumstances, which may render a departure from the above rules necessary in order to avoid immediate danger.”

Rules When Encountering Vessels

There are three main situations in which you may encounter other vessels and you must avoid a collision. These are:

- **Meeting** (you are approaching another vessel head-on)
- **Crossing** (you are traveling across the other vessel’s path)
- **Overtaking** (you are passing or being passed by another vessel)

Using the adjacent image in which you are boat in the center, you should give right-of-way to all vessels shown in the white area. In this instance, you are the give-way vessel. Both you and the meeting vessel must alter course to avoid each other.

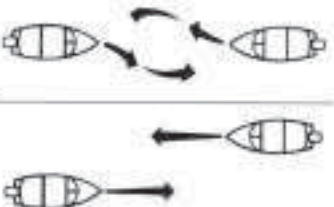

Meeting

If you are meeting another power vessel head-on, and you are close enough to run the risk of collision, neither of you has the right-of-way. Both of you should alter course to avoid an accident. You should keep the other vessel on your port (left) side. This rule doesn’t apply if both of you can clear each other by continuing your set course and speed.

Crossing

When two power-driven vessels are crossing each other's path close enough to run the risk of collision, the vessel that views the crossing vessel to the starboard (right) side must give-way.

If the other vessel is to the port (left) side, maintain your course and direction, provided the other vessel gives you the right-of-way as it should.

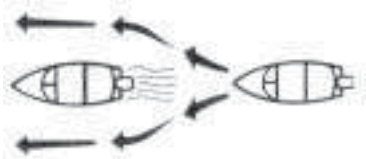
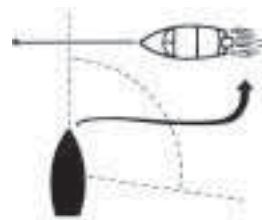

Overtaking

If you're passing another vessel, you are the give-way vessel. This means that the other vessel is expected to maintain its course and speed. You must stay out of its way as you clear it, altering your course and speed as necessary.

Conversely, if you are being passed by another vessel, you should maintain your speed and direction so that the vessel can steer itself around you.

Other Special Situations

There are other rules to always remember when driving your boat around other vessels:

- When navigating in narrow channel, you should keep to the right when it is safe and practical to do so.
- If the operator of a power-driven vessel is preparing to go around a bend that may obstruct the view of other water vessels, the operator should sound a prolonged blast on the whistle or horn for four to six seconds.
- If another vessel is around the bend, it too should sound the whistle or horn. Even if no reply is heard, however, the vessel should still proceed around the bend with caution.

Sailing Vessel Right-of-Way

Sailing vessels should normally be given the right-of-way.

The exceptions to this are:

- When the sailing vessel is overtaking the power-driven vessel, the power-driven vessel has the right-of-way.
- Sailing vessels should keep clear of any fishing vessel.
- In a narrow channel, a sailing vessel should not hamper the safe passage of a power-driven vessel that can navigate only in such a channel.

Fishing Vessel Right-of-Way

All vessels that are fishing with nets, lines or trawls are considered under international rules to be fishing vessels. Boats with trolling lines are not considered fishing vessels.

Fishing vessels have the right-of-way, regardless of position. But these vessels cannot impede the passage of other vessels in narrow channels.

Reading Buoys and Other Markers

The waters of the United States are marked for safe navigation by the lateral system of buoyage. The markers and buoys you will encounter have an arrangement of shapes, colors, numbers and lights to show which side of the buoy a boater should pass when navigating in a particular direction.

The markings on these buoys are oriented from the perspective of being entered from seaward while the boater is going toward the port. This means that red buoys are passed on the starboard (right) side when proceeding from open water into port, and the green buoys are to the port (left) side. When navigating out of port, your position to the buoys should be reversed: red buoys to port and green buoys to starboard.

Many boating bodies of water are entirely within the boundaries of a single state. The Uniform State Waterway Marking Systems have been devised for these waters. This system uses buoys and signs with distinctive shapes and colors to show regulatory or advisory information. These markers are white with black letters and orange borders. The information signifies speed zones, restricted areas, danger areas and general information.

Remember: Markings may vary by geographic location. Always consult local boating authorities before driving your boat in unfamiliar waters.

Nautical Terminology

Usually, boating rookies are immediately identifiable because they don't know the lingo. However, it's easy to pick up, and once you have you join the exclusive club that is the boating world.

To help you get a jump on understanding nautical terminology and communicating better with everyone you meet on the water, here are some of the more common terms:

ABROAD ... On or within the boat.

ABREAST ... Side by side; by the side of another boat or object.

ADRIFT ... Loose; not on moorings or towline.

AFT ... Toward the back (or stern) of the boat.

AGROUND ... Touching the bottom of the lake or river with the hull of the boat.

AHEAD ... In a forward direction.

AIDS TO NAVIGATION ... Artificial objects to supplement natural landmarks indicating safe or unsafe waters.

ALEE ... Away from the direction of the wind. Opposite of windward.

AMIDSHIPS ... In or toward the center of the boat.

ANCHORAGE ... A place suitable for anchoring in relation to the wind, seas and bottom.

ASTERN ... The position of the anchor as it is raised clear of the bottom.

BATTEN DOWN ... Secure hatches and loose objects both within the hull and on deck.

BEAM ... The greatest width of the boat.

BEARING ... The direction of an object expressed either as a true bearing as shown on the chart, or as a bearing relative to the boat's heading.

BELOW ... Beneath the deck.

BIGHT ... The part of the rope or line between the end and the standing part on which a knot is formed.

BOAT ... An indefinite term but generally refers to a waterborne vehicle smaller than a ship, which is usually thought of as being used for ocean travel or transport of goods.

BOAT HOOK ... A short shaft with a fitting at one end shaped to facilitate use in putting a line over a piling, recovering an object dropped overboard or in pushing off.

BOW ... The forward part of the boat, usually forward of the driver's compartment.

BOW LINE ... A docking line leading from the bow.

BUOY ... An anchored float used for marking a position on the water, a hazard or a shoal, and for mooring.

CAPSIZE ... To turn over.

CAST OFF ... To remove mooring lines and move away from the dock.

CHART ... A map for use by navigators.

CHINE ... The intersection of the bottom and sides of a flat or v-bottomed boat.

CHOCK ... A fitting through which anchor or mooring lines are led. Usually U-shaped to reduce chafe.

CLEAT ... A fitting to which lines are made fast. The classic cleat to which lines are secured is roughly anvil-shaped.

CLOVE HITCH ... A knot for temporarily fastening a line to a spar or piling.

COIL ... To lay a line down in circular turns to avoid snags or unwanted knots.

COURSE ... The direction in which a boat is steered.

CURRENT ... The horizontal movement of water.

DEAD AHEAD ... Directly ahead.

DEAD STERN ... Directly aft or behind.

DECK ... A permanent covering over a hull.

DISPLACEMENT ... The weight of water displaced by a floating vessel.

DOCK ... A protected water area in which vessels are moored. The term is often used to denote a pier or a wharf.



DOLPHIN ... A group of piles driven close together and bound with wire cables into a single structure.

DRAFT ... The depth a boat floats in the water.

EBB ... A receding current.

FATHOM ... Six feet down in the water.

FENDER ... A cushion, placed between boats or between a boat and a pier to prevent damage.

FIGURE EIGHT KNOT ... A knot in the form of a figure eight, placed in the end of a line to prevent the line from passing through a grommet or a block.

FLOOD ... An incoming current.

FLOORBOARDS ... The surface of the deck; usually removable sections placed for access to storage areas or the drive train.

FORE-AND-AFT ... In a line parallel to the keel.

FORWARD ... Toward the bow of the boat.

FOULED ... Any piece of equipment that is jammed or entangled.

GEAR ... A general term for ropes, blocks, skis, boards, and other equipment brought aboard.

GIVE-WAY VESSEL ... A term used to describe the vessel that must yield in meeting, crossing or overtaking situations (see *Rules of the Open Water* section).

GRAB RAILS ... Hand-hold fittings mounted for personal safety when moving around the boat.

GUNWALE ... (*also gunnel*) The upper edge of a boat's sides.

HARD CHINE ... An abrupt intersection between the hull side and the hull bottom created to affect a boat's wake and handling.

HEADING ... The direction in which a vessel's bow points at any given time.

HEADWAY ... The forward motion of a boat.

HULL ... The main body of a vessel.

INBOARD ... A type of boat in which the motor is inside the hull.

INTRACOASTAL WATERWAY (ICW) ... Bays, rivers and canals along the coasts, such as the Gulf of Mexico and Atlantic coasts, connected so that vessels may travel without going into the sea.

JETTY ... A structure, usually masonry, projecting out from the shore. A jetty may protect a harbor entrance.

KEEL ... The center line of a boat; the backbone of a vessel.

KNOT ... The measure of speed equal to one nautical mile (6076 feet) per hour.





LEE ... The side sheltered from the wind.

LEEWARD ... The direction away from the wind.

LEEWAY ... The sideways movement of the boat caused by wind or current.

LINE ... Rope and cordage used aboard a vessel.

LOT ... A record of courses or operation.

LUBBER'S LINE ... A mark or permanent line on a compass indicating the direction forward parallel to the keel.

MIDSHIP ... Approximately in a location equal distance from bow to stern.

MOORING ... An arrangement for securing a boat to a mooring buoy or a pier.

NAUTICAL MILE ... One minute of latitude; approximately 6076 feet or about 1/8 longer than the statute mile of 5280 feet.

NAVIGATION ... The art and science of conducting a boat safely from one point to another.

NAVIGATION RULES ... The regulations governing the movement of vessels in relation to each other.

OUTBOARD ... A detachable engine mounted on a boat's stern.

OVERBOARD ... Over the side or out of the boat.

PIER ... A loading platform extending at an angle from the shore.

PILE ... A wood, metal or concrete pole driven into the bottom.

PILOTING ... Navigation by use of visible references, the depth of the water, etc.

PLANING ... A boat is said to be planing when it is essentially moving over the top of the water rather than through the water.

PORT ... The left side of the boat when looking forward. Also used to refer to a harbor.

RUDDER ... A vertical plate of board for steering a boat.

RUN ... To allow a line to feed freely.

RUNNING LIGHTS ... Lights required to be shown on boats underway between sundown and sun up.

SCREW ... A boat's propeller.

SEA ROOM ... A safe distance from the shore or other hazards.

SEAWORTHY ... A boat or boat's gear able to meet the usual conditions.

SECURE ... To make fast.

SLACK ... Not fastened; loose.

SOUNDING ... A measurement of the depth of water.

SQUALL ... A sudden violent wind often accompanied by rain.

SQUARE KNOT ... A knot used to join two lines of similar size. Also called a "reef knot."

STARBOARD ... The right side of a boat when looking forward.

STEM ... The most forward part of the bow.

STERN ... The back-most part of the boat.

STERN LINE ... A docking line leading from the stern.

STOW ... To put an item away in its proper place.

SWAMP ... To fill with water, but not settle to the bottom.

TRANSOM ... The stern cross-section of a square-sterned boat.

TRIM ... Fore and aft balance of a boat.

UNDERWAY ... Vessel in motion.

V-BOTTOM ... A hull with the bottom section in the shape of a "V"

WAKE ... Moving waves, track or path that a boat leaves behind it when moving across the water.

WAY ... Movement of the vessel through the water such as a headway, sternway or leeway.

WINDWARD ... Toward the direction from which the wind is coming.

YAW ... To swing or steer off course.

The MasterCraft Design Process: The Perfect Blending of Art and Science

Our engineers and designers have never been able to leave well enough alone. Armed with true 3-D computer-aided design technology, they have a design approach that allows them to visualize and create every part of the boat on the computer—the same way it's done in the automotive industry. No other ski boat company even comes close to our technology—or to our talent. It's the most advanced team in the business, and the fruits of its labor are evident in every 2004 MasterCraft model. But at MasterCraft, we're not just designing better boats. We're designing better ways to build them. Today's MasterCrafts are built better, smarter and lighter. Which means you have the most durable, most carefree and most reliable boat on the planet.

Even with the most advanced technology available, however, MasterCraft will never replace an important step in the design: *Hands-on involvement*. Our artisans use clay modeling, inspired by the automotive industry, to touch and feel every surface of the boat before it ever sees a mold. Changes are made overnight. And re-made over and over again until every aspect of the ergonomics, styling and design is just right. When everything is flawless, we build the part, carefully crafting each piece by hand. This careful blending of technology, experience and intuition allows us to reduce the time it takes to introduce innovations into our boats.

We're proud of the balance we've achieved and of the results we're getting. For example, parametric modeling and finite element analysis allow us to create computerized images of each part long before we build it. We zero in to test stress levels and to perfect tolerances to the last thousandth of an inch. The result is a boat that has minimum weight and maximum strength—a boat that is powerful, durable and seamless from bow to stern.

The MasterCraft LifeMaster™ Construction Process

We use an exclusive process that we call LifeMaster™, an eight-step production method that gives every MasterCraft strength and reliability that ordinary boats cannot equal. We believe in this process so much that we offer a limited lifetime warranty on every new MasterCraft. The warranty is even transferable to a second owner for up to five years.

Step 1: Superior Molds

The first step in the LifeMaster™ Process is our boat molds. Our molds are built to tighter tolerances than most boats, with steel reinforcement to prevent flexing and to maintain precision. After every fourth



use, molds are hand-waxed with an industrial quality paste wax. This ensures a mirror-like gel coat finish and easy mold release. After 50 uses, every mold is sent back to the mold maintenance shop for a complete overhaul, allowing us to produce a boat with a superior finish. Also note that our molds are green in color. Our molds used to be orange, but we discovered that the green pigment was more environmentally friendly (*no lead*), so we switched.



Step 2: Gel Coat

Boats are built from the outside in. The first layer to be applied to the model is our special Ultimate 8000™ neopentyl glycol/isophthalic 20-mil gel coat. Our skilled production team can control our gel coat to tolerances within .005" for optimum strength, gloss and resistance to cracking, fading, blistering and water and chemical damage. Most manufacturers do not even have standards for gel coat thickness.

Some graphics are applied right in the gel coat, and this extra care pays off. New MasterCrafts come out of the mold with a gloss that looks like they were just waxed and buffed.

Step 3: Hand-Laid Fiberglass

There are many ways of building boats, but the best way we have found is to do it by hand. MasterCraft uses multiple layers of hand-laid fiberglass for the hull and structural components. Three types of fiberglass are used: matting, woven roving and coremat. There are even two types of woven roving—biaxial stitched and triaxial stitched cloth.

Why so many? Because the different types of fiberglass provide strength in different directions. The result is a hull that resists the tremendous forces generated by running across the water at high speed and taking tight turns.

Our hand-laid method is superior to chopper-gun fiberglass application because it ensures uniform strength and consistency throughout the boat. Chopper guns can create thin spots in the hull that are weak.



Step 4: Integral Monocoque™ Stringer System

MasterCraft uses no wood for structural components. Over time, wood weakens and rots. MasterCraft pioneered the use of fiberglass stringers (*or hull bracing system*) in ski boat construction.

All the way back in 1983, we developed an entirely new stringer system. The exclusive Monocoque™ stringers, constructed of bi-directional fiberglass and closed-cell foam, are precision built to aerospace tolerances, then fiberglassed into the hull so that they become an integral part of the structure. It is as if the hull and stringers are one single piece.

That means extra strength, more stability, and a great feel for the driver.

Step 5: Floor Liner

The fiberglass floor liner, another hull component that adds strength, is chemically bonded with GlassLock to the hull and stringers, under tons of pressure. The result is a bond that is stronger than the fiberglass itself, proven far superior to mechanical bonds that other companies use.

Then, 3/8" AnchorLOK reinforcement steel plates are laminated into the hull to provide rigid mounting points for the engine, ski pylon, rear lifting rings and the swim platform. Many boat companies mount the engine and other components directly into fiberglass or wood, resulting in stress cracking and inevitable failure.

Step 6: Foam Flotation

After the floor liner is in place, pressurized closed-cell flotation is injected into the spaces between the hull and floor liner to produce a solid, rigid, one-piece structure. Foam also deadens noise and provides positive flotation for the boat, which is an added safety feature.

Coast Guard regulations do not require foam in boats over 20-feet in length, but all MasterCraft models feature foam.

Step 7: Composite Floor Panels/Drive Train Covers

The next step in the process is to install floors made of composite materials in the hull of the boat to cover the drive train. These units are both strong and lightweight. Unlike wood, they will never warp or rot. This is critical because carpet can absorb water and hold it, causing wood floor panels to start deteriorating long before the rest of the boat.



Step 8: Bonding Deck and Hull

The final step in the LifeMaster™ process is to bond the deck and hull together. The deck is mechanically bonded to the hull with silicone and fasteners for strength, water tightness and durability.

Some companies simply use fasteners to bond the deck and hull together. This can create stress points in the fiberglass. Others use fiberglass to seal the joint, but this can cause problems if there is ever a need to remove the deck for a major repair.

Our system uses stainless steel fasteners that are anchored into a high density polyethylene DuraBak backing strip. This takes the pressure off the fiberglass and provides a bond that is exceptionally strong—but can be taken apart if there is ever the need for a major repair.

Small Fiberglass Parts

Like the hull of the boat, all small fiberglass components, such as trailer fenders and motor boxes are constructed of hand-laid fiberglass for strength. A separate manufacturing line is dedicated to these components.

Putting the Pieces Together: Rigging

On the rigging line, all interior components such as engines, fuel tanks, carpet, upholstery and finish details are hand-installed by skilled craftspeople. Every MasterCraft comes pre-wired for available options and has a moisture-proof wiring harness. The order of installation has been carefully choreographed so that parts are never in the way of workers and therefore do not get damaged.



MasterCraft Marine Power Engines By Indmar

The standard engine for 2004 is the Predator, a Vortec 5.7-liter V-8 engine with electronic throttle-body fuel injection. One ride makes it clear how it got its name. For those who want even more power, however, there is also the optional 5.7-liter MCX™. This 350-horsepower ski-specific, multi-port EFI V-8 is Vortec-based and features an exclusive MasterCraft/Indmar fuel delivery system with an elongated, ski-tuned plenum. It produces jump-up acceleration and an astonishingly broad, flat torque curve all the way to wide-open-throttle. And the big daddy, the new Vortec L18 HO 8.1-liter V-8 with 496 cubic inches puts out a whopping 450 horsepower.

Our exclusive EFI Management System™ controls all our engines in three key areas: fuel, spark and air. This system constantly monitors more than

30 engine factors to calculate the optimum performance under any load, in any condition and at any altitude. We program each electronic control module (ECM) to pinpoint the optimal RPMs, fuel quality and coolant temperature needed to give each engine model maximum skiability. If there's a problem the ECM reacts within microseconds to correct it or to prevent any further damage to the engine.

That is what makes our engines smarter. But they are tougher, too, because of extra quality steps like a waterproof ECM, a seven-step paint process, precision machining of components and crankshaft-driven water pumps. And don't forget, MasterCraft engines come with a three-year warranty.

But we couldn't talk about engines this year and forget the award-winning Cadillac® Northstar®, which cranks out tons of torque at every speed from idle to full-throttle. However, its torque release is biased toward mid-range situations. This engine has power exactly where the skier wants it.

Limp-home mode shuts down individual cylinders if the engine ever loses coolant. Each Northstar® engine comes standard with a closed cooling system and is mated to MasterCraft's famous 1.5:1 PowerSlot transmission.

It's fitting that MasterCraft would team up with Cadillac®. And that, of all the boat manufacturers in the world, Cadillac® would choose to align itself with MasterCraft and Indmar.

Upholstery

MasterCraft produces its own custom upholstery using multiple layers of high density CelMaster™ foam, rotocast polyethylene frames and backs (*instead of wood*), premium vinyl and triple stitching.

MasterCraft uses the highest grade marine vinyl with more than double the surface weight and 20% more tear-resistance than vinyl used on other boats. It is treated with mildew inhibitors and UV-protected triple stitching combined with reinforced backing and





heavy-duty UV-protected thread keeps the upholstery together. It has been rigidly tested under all sorts of circumstances to make sure it keeps its color and does not crack, even after years of use. In some places, the vinyl is foam-backed so that it gives a more defined curve around edges and provides a more tailored look.

Our upholsterers are experienced craftspeople. Some have more than 20 years of upholstery experience. And every metal component on a MasterCraft is either stainless steel or other non-corrosive material. Even upholstery staples are marine grade stainless steel. Upholstery has a one-year warranty.

Lake Testing

Every MasterCraft that comes off our assembly line must pass a 30-point quality assurance on-the-water test. A TECH1 analyzer is used to check for engine anomalies and to calibrate all gauges. Steps are taken to resolve any issues before the boat can be prepped for shipment.

Final Finish

Although our Ultimate 8000™ gel coat has remarkable luster on its own, every new MasterCraft is carefully cleaned and mirror-glazed before it is loaded.

Many of our new owners show up to see their new boat unloaded off the truck, and we want to make sure that it is love at first sight! Our boats are also shrink-wrapped to keep them clean and carefully loaded onto our own trailers for delivery.

Custom Trailers

MasterCraft trailers are custom-made to precisely fit our ski boats. They are made of tubular steel for strength, with steel reinforced fiberglass fenders.

Trailers are carefully prepped after they are welded together because we think the finish on the trailers is as important as the finish on the boat. All trailers have a two-part polyurethane point system for a lasting finish. The paint is matched to the base color of the boat.

Here are some other important trailer features:

- Radial tires with custom MasterCraft aluminum rims.*
- Standard disc brakes on all trailers.*
- Tandem axle trailers get disc brakes on both axles.*
- Standard Bearing Buddy for longer life, less maintenance.*
- EZ Load system makes it easier to get the boat out of the water.*
- Coiled covered safety cables instead of chains.*
- Guide bars.*
- Waterproof lights.*



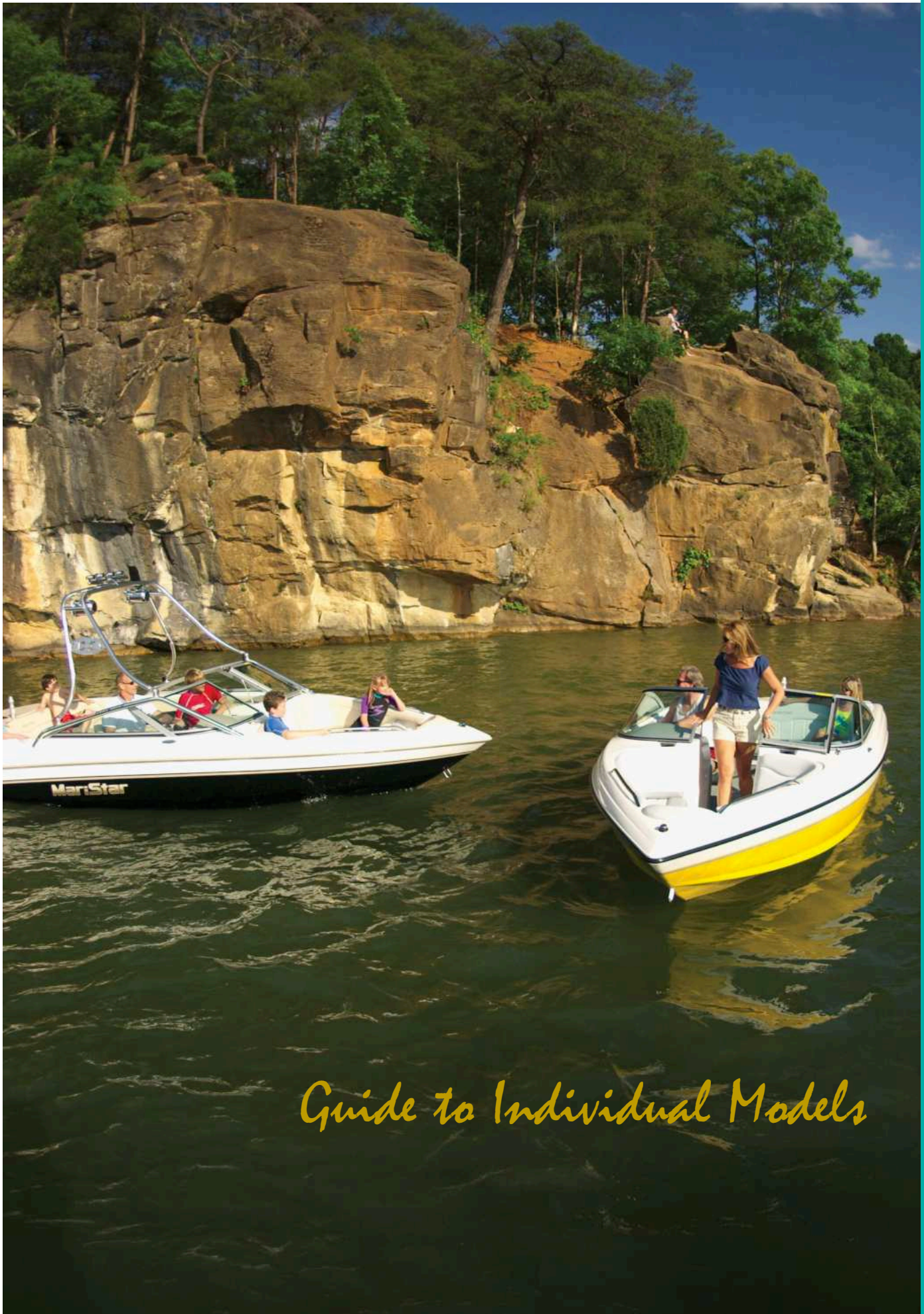

Guide to Individual Models

ProStar 190

- A FUEL TANK FILLER
- B BLOWER EXHAUST
- C SWIM PLATFORM
- D STERN LIGHT RECEPTACLE
- E STORAGE UNDER SUN PAD
- F ENGINE COMPARTMENT
- G THROTTLE/SHIFT CONTROL
- H INSTRUMENT PANEL
- I BOW LIGHT
- J GLOVE BOX
- K BATTERY (UNDER SEAT)
- L DRAIN PLUG



LENGTH OF BOAT: 19'8"
 OVERALL LENGTH W/TRAILER: 22'8"
 LENGTH W/SWING-AWAY TONGUE FOLDED 21'
 WIDTH AMIDSHIP: 92"
 OVERALL WIDTH W/TRAILER 100"
 BOAT WEIGHT: 2,620 LBS. (APPROX.)
 SINGLE AXLE TRAILER WEIGHT: 860 LBS.
 TANDEM AXLE TRAILER WEIGHT: 1,040 LBS.
 FUEL CAPACITY: 31 GALLONS
 CAPACITY: 6 PEOPLE OR 900 LBS.

- A OIL PRESSURE GAUGE
- B ENGINE TEMPERATURE GAUGE
- C SPEEDOMETER
- D MULTI-FUNCTION/TACHOMETER
- E CHECK ENGINE LIGHT
- F SPEEDOMETER OR PERFECT PASS GAUGE
- G VOLTMETER
- H FUEL GAUGE
- I HORN
- J ACCESSORY 1 SWITCH
- K ACCESSORY 2 SWITCH
- L COURTESY LIGHTS SWITCH
- M SPEEDO AJUSTMENT SWITCHES
- N CLOCK ADJUSTMENT SWITCH
- O NAV/ANCHOR LIGHTS SWITCH
- P BILGE PUMP SWITCH
- Q BLOWER
- R IGNITION KEY SLOT



ProStar 197



- A FUEL TANK FILLER
- B BLOWER EXHAUST
- C SWIM PLATFORM
- D STERN LIGHT RECEPTACLE
- E STORAGE UNDER SUN PAD
- F ENGINE COMPARTMENT
- G THROTTLE/SHIFT CONTROL
- H INSTRUMENT PANEL
- I BOW LIGHT
- J GLOVE BOX
- K BATTERY (UNDER SEAT)
- L DRAIN PLUG

LENGTH OF BOAT: 19'8"
 OVERALL LENGTH W/TRAILER: 22'8"
 LENGTH W/SWING-AWAY TONGUE FOLDED: 21'
 WIDTH AMIDSHIP: 92"
 OVERALL WIDTH W/TRAILER 100"
 BOAT HEIGHT W/WINDSHIELD 60-1/2"
 HEIGHT W/WINDSHIELD & TRAILER (TA) 72-1/2"
 HEIGHT W/WINDSHIELD & TRAILER (SA) 74"
 HEIGHT W/TOWER FOLDED ON TRAILER (TA) . 84-1/2"
 HEIGHT W/TOWER FOLDED ON TRAILER (SA) 86"
 BOAT WEIGHT: 2,800 LBS. (APPROX.)
 SINGLE AXLE TRAILER WEIGHT: 860 LBS.
 TANDEM AXLE TRAILER WEIGHT: 1,040 LBS.
 FUEL CAPACITY: 31 GALLONS
 CAPACITY: 6 PEOPLE OR 900 LBS.



- A OIL PRESSURE GAUGE
- B ENGINE TEMPERATURE GAUGE
- C SPEEDOMETER
- D MULTI-FUNCTION/TACHOMETER
- E CHECK ENGINE LIGHT
- F SPEEDOMETER OR PERFECT PASS GAUGE
- G VOLTMETER
- H FUEL GAUGE
- I HORN
- J ACCESSORY 1 SWITCH
- K ACCESSORY 2 SWITCH
- L COURTESY LIGHTS SWITCH
- M SPEEDO AJUSTMENT SWITCHES
- N CLOCK ADJUSTMENT SWITCH
- O NAV/ANCHOR LIGHTS SWITCH
- P BILGE PUMP SWITCH
- Q BLOWER
- R IGNITION KEY SLOT

ProStar 209

- A FUEL TANK FILLER
- B BLOWER EXHAUST
- C SWIM PLATFORM
- D STERN LIGHT RECEPTACLE
- E STORAGE UNDER SUN PAD
- F ENGINE COMPARTMENT
- G THROTTLE/SHIFT CONTROL
- H INSTRUMENT PANEL
- I BOW LIGHT
- J GLOVE BOX
- K BATTERY (UNDER SEAT)
- L DRAIN PLUG



LENGTH OF BOAT: 20'11-1/2"
 OVERALL LENGTH W/TRAILER: 22'11-1/2"
 LENGTH W/SWING-AWAY TONGUE FOLDED: . 21'3-1/2"
 WIDTH AMIDSHIP: 96"
 OVERALL WIDTH W/TRAILER 100"
 BOAT HEIGHT W/WINDSHIELD 67"
 HEIGHT W/WINDSHIELD & TRAILER (TA) 79"
 HEIGHT W/WINDSHIELD & TRAILER (SA) 80-1/2"
 HEIGHT W/TOWER FOLDED ON TRAILER (TA) 88"
 HEIGHT W/TOWER FOLDED ON TRAILER (SA) . 89-1/2"
 BOAT WEIGHT: 2,850 LBS. (APPROX.)
 SINGLE AXLE TRAILER WEIGHT: 900 LBS.
 TANDEM AXLE TRAILER WEIGHT: 1,050 LBS.
 FUEL CAPACITY: 34 GALLONS
 CAPACITY: 9 PEOPLE OR 1,370 LBS.

- A OIL PRESSURE GAUGE
- B ENGINE TEMPERATURE GAUGE
- C SPEEDOMETER
- D MULTI-FUNCTION/TACHOMETER
- E CHECK ENGINE LIGHT
- F SPEEDOMETER OR PERFECT PASS GAUGE
- G VOLTMETER
- H FUEL GAUGE
- I HORN
- J ACCESSORY 1 SWITCH
- K ACCESSORY 2 SWITCH
- L COURTESY LIGHTS SWITCH
- M SPEEDO AJUSTMENT SWITCHES
- N CLOCK ADJUSTMENT SWITCH
- O NAV/ANCHOR LIGHTS SWITCH
- P BILGE PUMP SWITCH
- Q BLOWER
- R IGNITION KEY SLOT



ProStar 205 V-DRIVE



- A STERN LIGHT RECEPTACLE
- B BLOWER EXHAUST
- C SWIM PLATFORM
- D FUEL TANK FILLER
- E STORAGE UNDER SUN PAD
- F ENGINE COMPARTMENT
- G THROTTLE/SHIFT CONTROL
- H INSTRUMENT PANEL
- I BOW LIGHT
- J GLOVE BOX
- K BATTERY (UNDER SEAT)
- L SKI LOCKER
- M DRAIN PLUGS

LENGTH OF BOAT: 20'7"
 OVERALL LENGTH W/TRAILER: 22'4"
 LENGTH W/SWING-AWAY TONGUE FOLDED: 20'8"
 WIDTH AMIDSHIP: 90"
 OVERALL WIDTH W/TRAILER 96"
 BOAT HEIGHT W/WINDSHIELD 62"
 HEIGHT W/WINDSHIELD & TRAILER (TA) 76-1/2"
 HEIGHT W/WINDSHIELD & TRAILER (SA) 78"
 HEIGHT W/TOWER FOLDED ON TRAILER (TA) . 88-1/2"
 HEIGHT W/TOWER FOLDED ON TRAILER (SA) 90"
 BOAT WEIGHT: 3,050 LBS. (APPROX.)
 SINGLE AXLE TRAILER WEIGHT: 860 LBS.
 TANDEM AXLE TRAILER WEIGHT: 1,040 LBS.
 FUEL CAPACITY: 33 GALLONS
 CAPACITY: 11 PEOPLE OR 1,615 LBS.

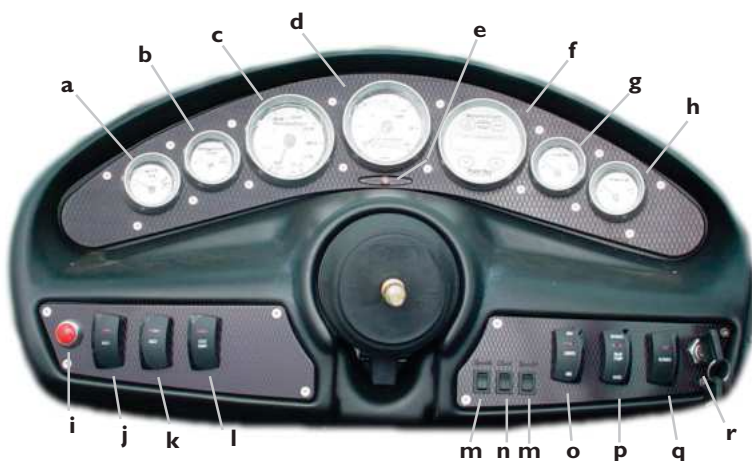

- A OIL PRESSURE GAUGE
- B ENGINE TEMPERATURE GAUGE
- C SPEEDOMETER
- D MULTI-FUNCTION/TACHOMETER
- E CHECK ENGINE LIGHT
- F SPEEDOMETER OR PERFECT PASS GAUGE
- G VOLTMETER
- H FUEL GAUGE
- I HORN
- J ACCESSORY 1 SWITCH
- K ACCESSORY 2 SWITCH
- L COURTESY LIGHTS SWITCH
- M SPEEDO AJUSTMENT SWITCHES
- N CLOCK ADJUSTMENT SWITCH
- O NAV/ANCHOR LIGHTS SWITCH
- P BILGE PUMP SWITCH
- Q BLOWER
- R IGNITION KEY SLOT

MariStar 210

- A STERN LIGHT RECEPTACLE
- B BLOWER EXHAUST
- C SWIM PLATFORM
- D FUEL TANK FILLER
- E STORAGE UNDER SUN PAD
- F BATTERY (BEHIND SEAT)
- G THROTTLE/SHIFT CONTROL
- H INSTRUMENT PANEL
- I BOW LIGHT
- J GLOVE BOX
- K SKI LOCKER
- L ENGINE COMPARTMENT
- M DRAIN PLUGS



- LENGTH OF BOAT: 20'9"
- OVERALL LENGTH W/TRAILER: 22'7"
- LENGTH W/SWING-AWAY TONGUE FOLDED: 20'11"
- WIDTH AMIDSHIP: 95"
- OVERALL WIDTH W/TRAILER 100"
- BOAT HEIGHT W/WINDSHIELD 68"
- HEIGHT W/WINDSHIELD & TRAILER (TA) 80-1/2"
- HEIGHT W/WINDSHIELD & TRAILER (SA) 81-1/2"
- HEIGHT W/TOWER FOLDED ON TRAILER (TA) 92-1/2"
- HEIGHT W/TOWER FOLDED ON TRAILER (SA) 94"
- BOAT WEIGHT: 3,075 LBS. (APPROX.)
- SINGLE AXLE TRAILER WEIGHT: 900 LBS.
- TANDEM AXLE TRAILER WEIGHT: 1,050 LBS.
- FUEL CAPACITY: 45 GALLONS
- CAPACITY: 10 PEOPLE OR 1,590 LBS.

- A OIL PRESSURE GAUGE
- B ENGINE TEMPERATURE GAUGE
- C MULTI-FUNCTION/TACHOMETER
- D CHECK ENGINE LIGHT
- E SPEEDOMETER OR PERFECT PASS
- F VOLTMETER
- G FUEL GAUGE
- H HORN
- I 12-VOLT RECEPTACLE
- J GAUGE DISPLAY SELECTOR
- K SPEEDOMETER CALIBRATOR
- L BLOWER SWITCH
- M IGNITION KEY SLOT
- N STEREO INSERT
- O ACCESSORY 1 SWITCH
- P ACCESSORY 2 SWITCH
- Q COURTESY LIGHTS SWITCH
- R NAVIGATION/ANCHOR LIGHT SWITCH
- S BILGE PUMP SWITCH
- T ACCESSORY

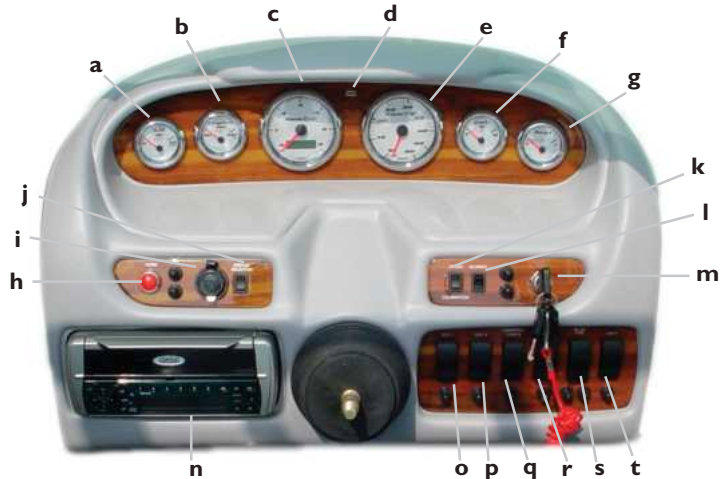

MariStar 230



- A STERN LIGHT RECEPTACLE
- B BLOWER EXHAUST
- C SWIM PLATFORM
- D FUEL TANK FILLER
- E STORAGE UNDER SUN PAD
- F BATTERY (BEHIND SEAT)
- G THROTTLE/SHIFT CONTROL
- H INSTRUMENT PANEL
- I BOW LIGHT
- J GLOVE BOX
- K SKI LOCKER
- L ENGINE COMPARTMENT
- M DRAIN PLUGS

LENGTH OF BOAT: 22'8"
 OVERALL LENGTH W/TRAILER: 24'7"
 LENGTH W/SWING-AWAY TONGUE FOLDED: 22'11"
 WIDTH AMIDSHIP: 98"
 OVERALL WIDTH W/TRAILER 100"
 BOAT HEIGHT W/WINDSHIELD 68"
 HEIGHT W/WINDSHIELD & TRAILER (TA) 80-1/2"
 HEIGHT W/WINDSHIELD & TRAILER (SA) 81-1/2"
 HEIGHT W/TOWER FOLDED ON TRAILER (TA) . 92-1/2"
 HEIGHT W/TOWER FOLDED ON TRAILER (SA) 94"
 BOAT WEIGHT: 3,300 LBS. (APPROX.)
 SINGLE AXLE TRAILER WEIGHT: 900 LBS.
 TANDEM AXLE TRAILER WEIGHT: 1,050 LBS.
 FUEL CAPACITY: 60 GALLONS
 CAPACITY: 12 PEOPLE OR 1,840 LBS.

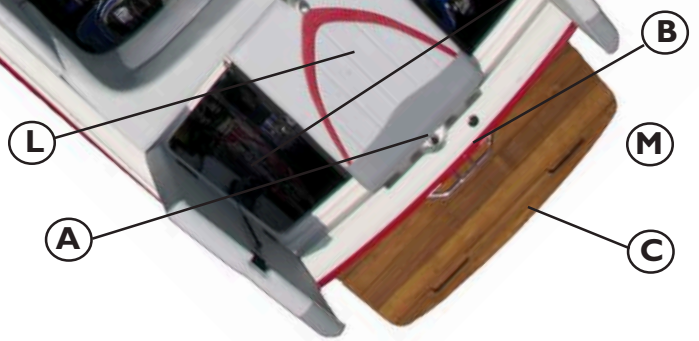

- A OIL PRESSURE GAUGE
- B ENGINE TEMPERATURE GAUGE
- C MULTI-FUNCTION/TACHOMETER
- D CHECK ENGINE LIGHT
- E SPEEDOMETER OR PERFECT PASS
- F VOLTMETER
- G FUEL GAUGE
- H HORN
- I 12-VOLT RECEPTACLE
- J GAUGE DISPLAY SELECTOR
- K SPEEDOMETER CALIBRATOR
- L BLOWER SWITCH
- M IGNITION KEY SLOT
- N STEREO INSERT
- O ACCESSORY 1 SWITCH
- P ACCESSORY 2 SWITCH
- Q COURTESY LIGHTS SWITCH
- R NAVIGATION/ANCHOR LIGHT SWITCH
- S BILGE PUMP SWITCH
- T ACCESSORY

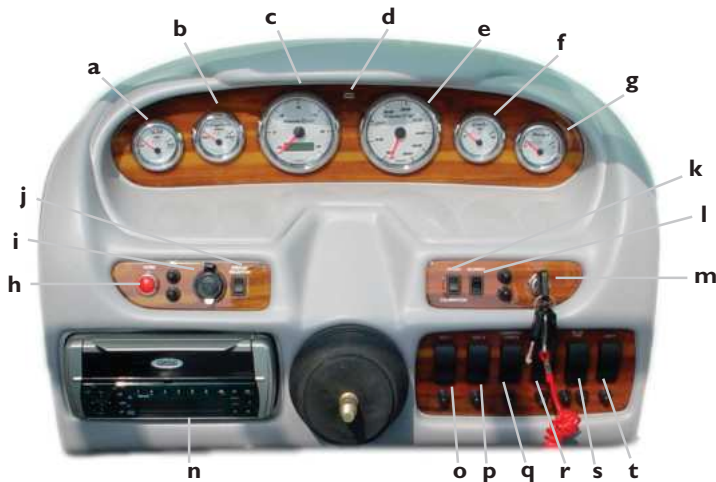

MariStar 280

- A BLOWER EXHAUST
- B SWIM PLATFORM
- C FUEL TANK FILLERS
- D BATTERIES
- E THROTTLE/SHIFT CONTROL
- F INSTRUMENT PANEL
- G BOW LIGHTS
- H SKI LOCKER
- I ENGINE COMPARTMENT
- J SINK
- K HEAD
- L DRAIN PLUG

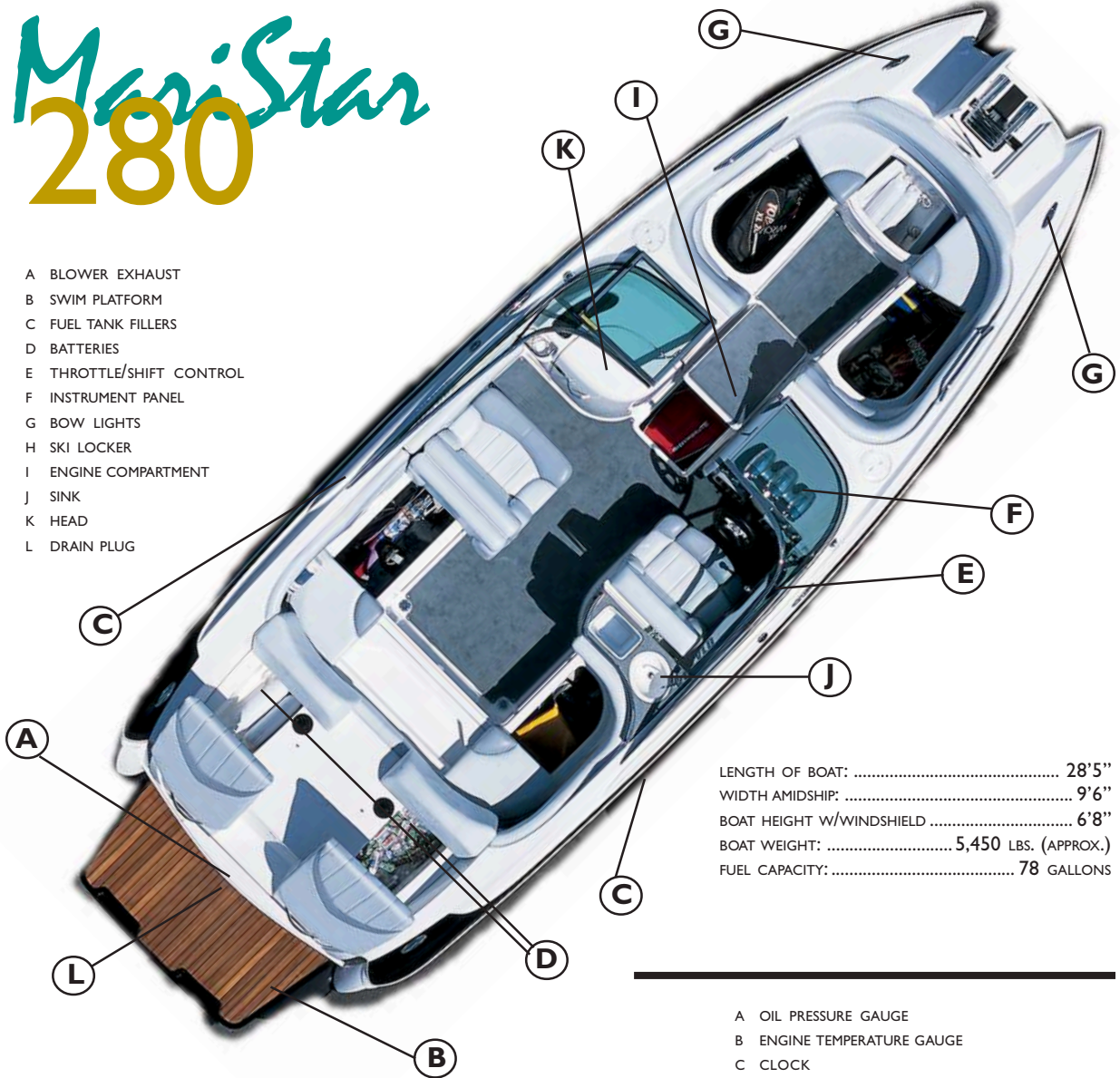

LENGTH OF BOAT: 28'5"
 WIDTH AMIDSHIP: 9'6"
 BOAT HEIGHT W/WINDSHIELD 6'8"
 BOAT WEIGHT: 5,450 LBS. (APPROX.)
 FUEL CAPACITY: 78 GALLONS

- E SPEEDOMETER
- F PERFECT PASS GAUGE
- G VOLTMETER
- H DEPTH FINDER
- I FUEL GAUGE
- J HORN
- K CLOCK ADJUSTMENT SWITCH
- L SPEEDOMETER ADJUSTMENT SWITCH
- M COURTESY LIGHTS SWITCH
- N SHOWER SWITCH
- O HEATHER SWITCH
- P ACCESSORY 1
- Q ACCESSORY 2
- R ACCESSORY 3
- S TOWER LIGHT SWITCH
- T TOWER LIGHT SWITCH
- U BLOWER SWITCH
- V BILGE SWITCH
- W NAV/ANCHOR LIGHTS SWITCH

- A OIL PRESSURE GAUGE
- B ENGINE TEMPERATURE GAUGE
- C CLOCK
- D TACHOMETER



X-2

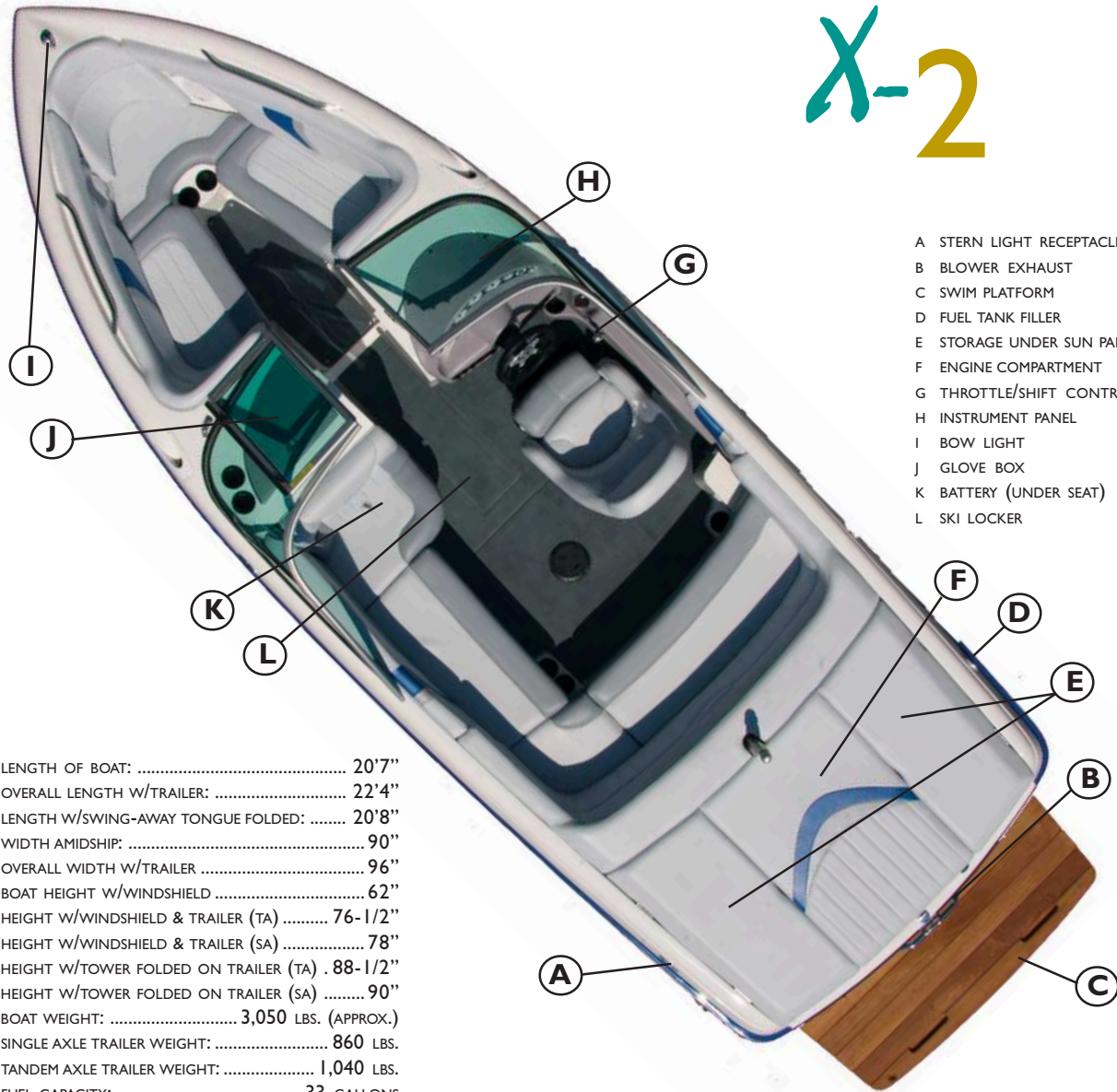

LENGTH OF BOAT: 20'7"
 OVERALL LENGTH W/TRAILER: 22'4"
 LENGTH W/SWING-AWAY TONGUE FOLDED: 20'8"
 WIDTH AMIDSHIP: 90"
 OVERALL WIDTH W/TRAILER 96"
 BOAT HEIGHT W/WINDSHIELD 62"
 HEIGHT W/WINDSHIELD & TRAILER (TA) 76-1/2"
 HEIGHT W/WINDSHIELD & TRAILER (SA) 78"
 HEIGHT W/TOWER FOLDED ON TRAILER (TA) . 88-1/2"
 HEIGHT W/TOWER FOLDED ON TRAILER (SA) 90"
 BOAT WEIGHT: 3,050 LBS. (APPROX.)
 SINGLE AXLE TRAILER WEIGHT: 860 LBS.
 TANDEM AXLE TRAILER WEIGHT: 1,040 LBS.
 FUEL CAPACITY: 33 GALLONS
 CAPACITY: 11 PEOPLE OR 1,615 LBS.

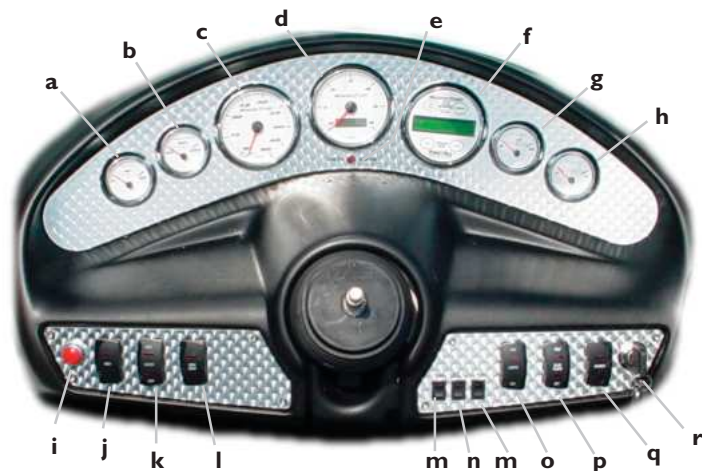

- A OIL PRESSURE GAUGE
- B ENGINE TEMPERATURE GAUGE
- C SPEEDOMETER
- D MULTI-FUNCTION/TACHOMETER
- E CHECK ENGINE LIGHT
- F SPEEDOMETER OR PERFECT PASS GAUGE
- G VOLTMETER
- H FUEL GAUGE
- I HORN
- J ACCESSORY 1 SWITCH
- K ACCESSORY 2 SWITCH
- L COURTESY LIGHTS SWITCH
- M SPEEDO ADJUSTMENT SWITCHES
- N CLOCK ADJUSTMENT SWITCH
- O NAV/ANCHOR LIGHTS SWITCH
- P BILGE PUMP SWITCH
- Q BLOWER
- R IGNITION KEY SLOT

X-7

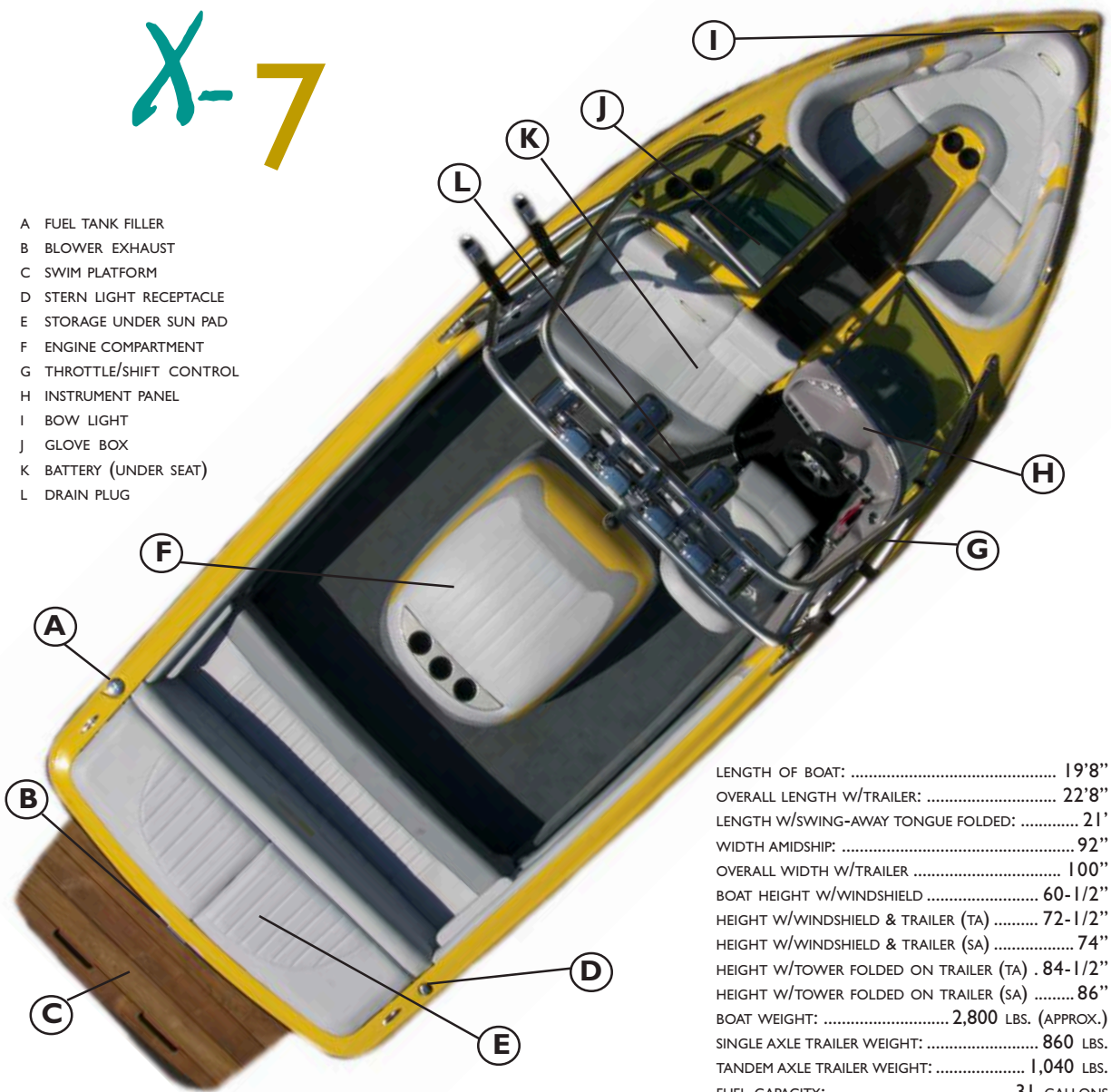

- A FUEL TANK FILLER
- B BLOWER EXHAUST
- C SWIM PLATFORM
- D STERN LIGHT RECEPTACLE
- E STORAGE UNDER SUN PAD
- F ENGINE COMPARTMENT
- G THROTTLE/SHIFT CONTROL
- H INSTRUMENT PANEL
- I BOW LIGHT
- J GLOVE BOX
- K BATTERY (UNDER SEAT)
- L DRAIN PLUG

LENGTH OF BOAT: 19'8"
 OVERALL LENGTH W/TRAILER: 22'8"
 LENGTH W/SWING-AWAY TONGUE FOLDED: 21'
 WIDTH AMIDSHIP: 92"
 OVERALL WIDTH W/TRAILER 100"
 BOAT HEIGHT W/WINDSHIELD 60-1/2"
 HEIGHT W/WINDSHIELD & TRAILER (TA) 72-1/2"
 HEIGHT W/WINDSHIELD & TRAILER (SA) 74"
 HEIGHT W/TOWER FOLDED ON TRAILER (TA) 84-1/2"
 HEIGHT W/TOWER FOLDED ON TRAILER (SA) 86"
 BOAT WEIGHT: 2,800 LBS. (APPROX.)
 SINGLE AXLE TRAILER WEIGHT: 860 LBS.
 TANDEM AXLE TRAILER WEIGHT: 1,040 LBS.
 FUEL CAPACITY: 31 GALLONS
 CAPACITY: 6 PEOPLE OR 900 LBS.

- A OIL PRESSURE GAUGE
- B ENGINE TEMPERATURE GAUGE
- C SPEEDOMETER
- D MULTI-FUNCTION/TACHOMETER
- E CHECK ENGINE LIGHT
- F SPEEDOMETER OR PERFECT PASS GAUGE
- G VOLTMETER
- H FUEL GAUGE
- I HORN
- J ACCESSORY 1 SWITCH
- K ACCESSORY 2 SWITCH
- L COURTESY LIGHTS SWITCH
- M SPEEDO AJUSTMENT SWITCHES
- N CLOCK ADJUSTMENT SWITCH
- O NAV/ANCHOR LIGHTS SWITCH
- P BILGE PUMP SWITCH
- Q BLOWER
- R IGNITION KEY SLOT



X-9

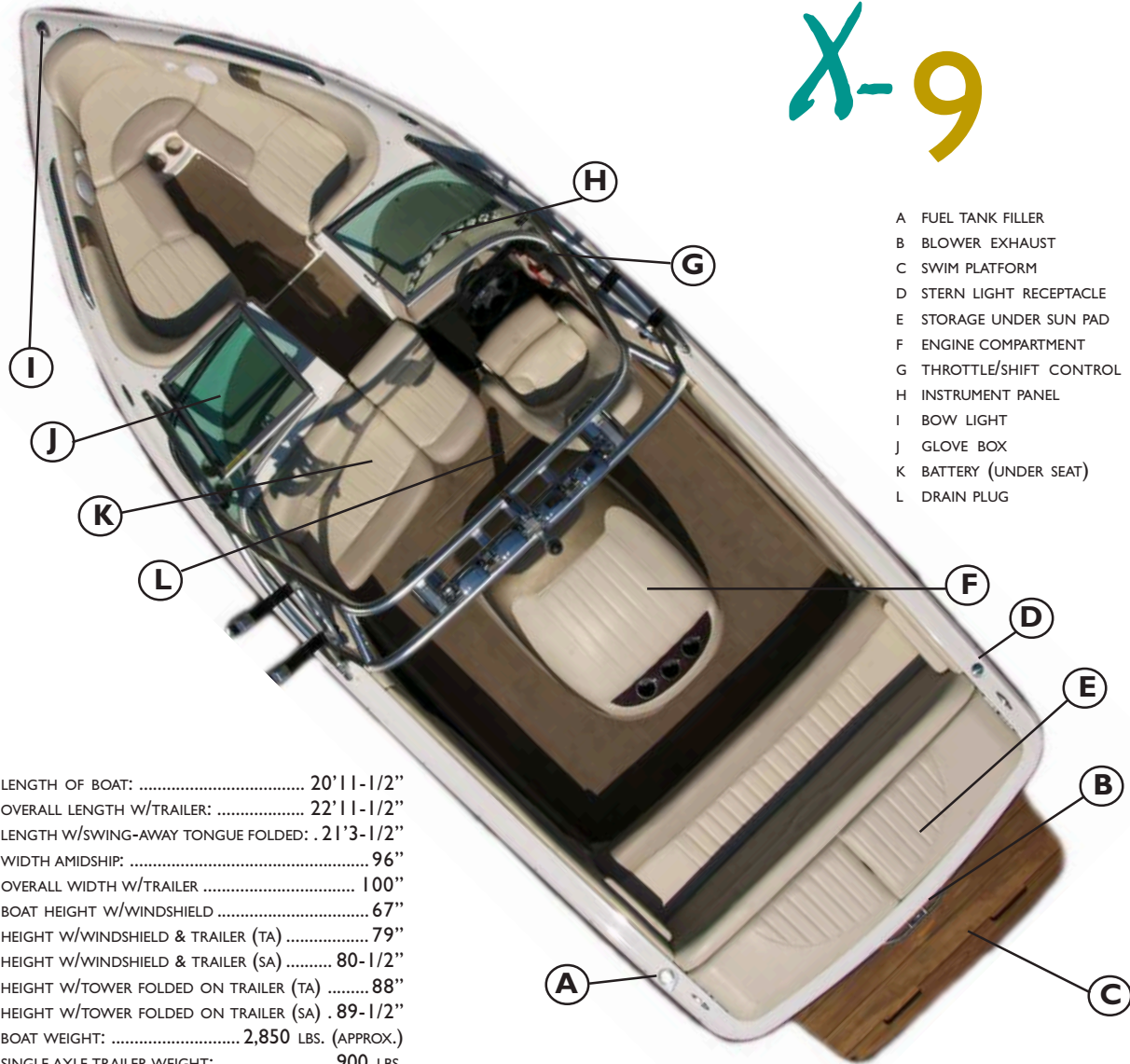

- A FUEL TANK FILLER
- B BLOWER EXHAUST
- C SWIM PLATFORM
- D STERN LIGHT RECEPTACLE
- E STORAGE UNDER SUN PAD
- F ENGINE COMPARTMENT
- G THROTTLE/SHIFT CONTROL
- H INSTRUMENT PANEL
- I BOW LIGHT
- J GLOVE BOX
- K BATTERY (UNDER SEAT)
- L DRAIN PLUG

LENGTH OF BOAT: 20'11-1/2"
 OVERALL LENGTH W/TRAILER: 22'11-1/2"
 LENGTH W/SWING-AWAY TONGUE FOLDED: . 21'3-1/2"
 WIDTH AMIDSHIP: 96"
 OVERALL WIDTH W/TRAILER 100"
 BOAT HEIGHT W/WINDSHIELD 67"
 HEIGHT W/WINDSHIELD & TRAILER (TA) 79"
 HEIGHT W/WINDSHIELD & TRAILER (SA) 80-1/2"
 HEIGHT W/TOWER FOLDED ON TRAILER (TA) 88"
 HEIGHT W/TOWER FOLDED ON TRAILER (SA) . 89-1/2"
 BOAT WEIGHT: 2,850 LBS. (APPROX.)
 SINGLE AXLE TRAILER WEIGHT: 900 LBS.
 TANDEM AXLE TRAILER WEIGHT: 1,050 LBS.
 FUEL CAPACITY: 34 GALLONS
 CAPACITY: 9 PEOPLE OR 1,370 LBS.



- A OIL PRESSURE GAUGE
- B ENGINE TEMPERATURE GAUGE
- C SPEEDOMETER
- D MULTI-FUNCTION/TACHOMETER
- E CHECK ENGINE LIGHT
- F SPEEDOMETER OR PERFECT PASS GAUGE
- G VOLTMETER
- H FUEL GAUGE
- I HORN
- J ACCESSORY 1 SWITCH
- K ACCESSORY 2 SWITCH
- L COURTESY LIGHTS SWITCH
- M SPEEDO ADJUSTMENT SWITCHES
- N CLOCK ADJUSTMENT SWITCH
- O NAV/ANCHOR LIGHTS SWITCH
- P BILGE PUMP SWITCH
- Q BLOWER
- R IGNITION KEY SLOT

X-10

- A STERN LIGHT RECEPTACLE
- B BLOWER EXHAUST
- C SWIM PLATFORM
- D FUEL TANK FILLER
- E STORAGE UNDER SUN PAD
- F BATTERY (BEHIND SEAT)
- G THROTTLE/SHIFT CONTROL
- H INSTRUMENT PANEL
- I BOW LIGHT
- J GLOVE BOX
- K SKI LOCKER
- L ENGINE COMPARTMENT
- M DRAIN PLUGS

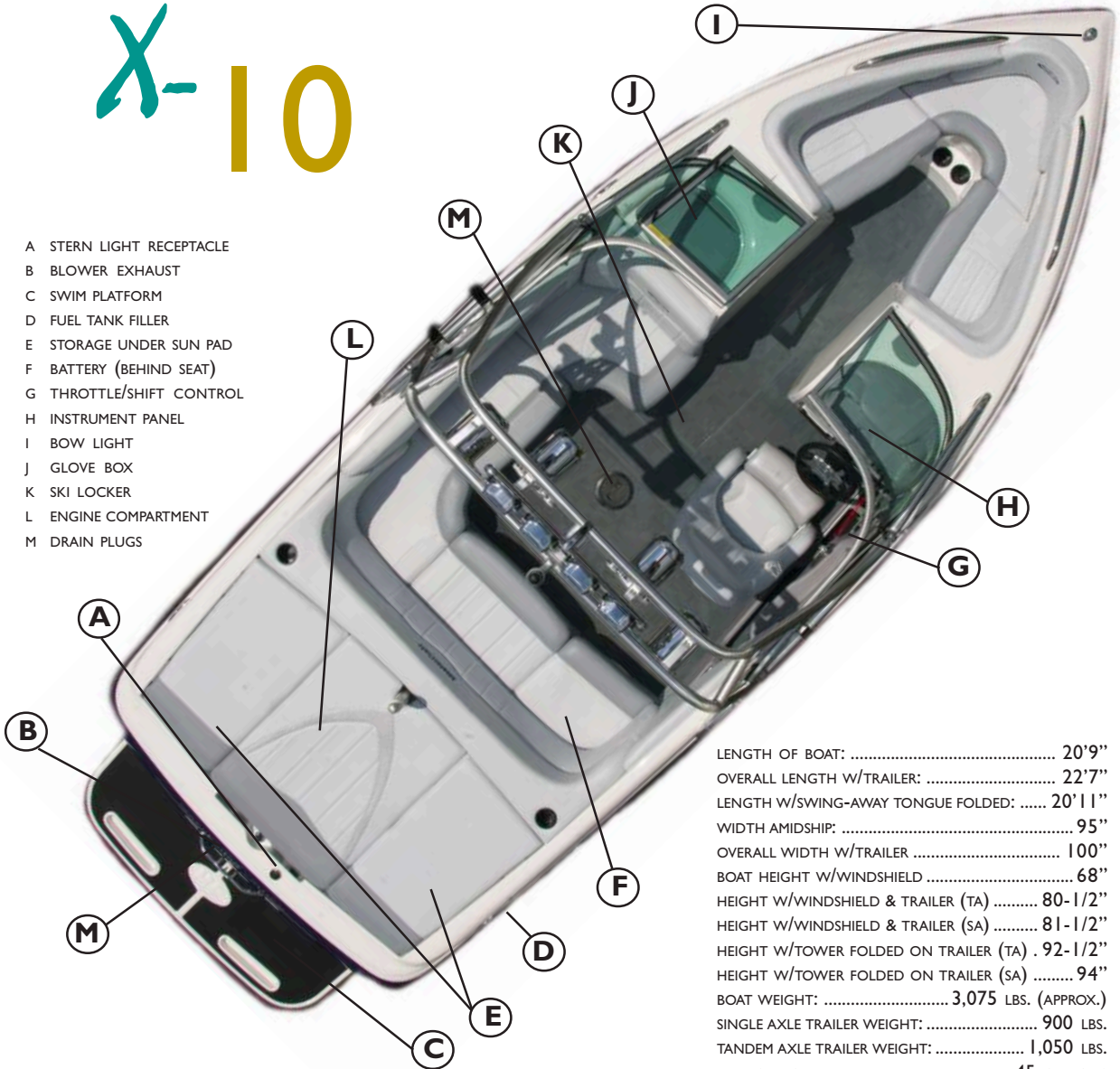

LENGTH OF BOAT: 20'9"
 OVERALL LENGTH W/TRAILER: 22'7"
 LENGTH W/SWING-AWAY TONGUE FOLDED: 20'11"
 WIDTH AMIDSHIP: 95"
 OVERALL WIDTH W/TRAILER 100"
 BOAT HEIGHT W/WINDSHIELD 68"
 HEIGHT W/WINDSHIELD & TRAILER (TA) 80-1/2"
 HEIGHT W/WINDSHIELD & TRAILER (SA) 81-1/2"
 HEIGHT W/TOWER FOLDED ON TRAILER (TA) . 92-1/2"
 HEIGHT W/TOWER FOLDED ON TRAILER (SA) 94"
 BOAT WEIGHT: 3,075 LBS. (APPROX.)
 SINGLE AXLE TRAILER WEIGHT: 900 LBS.
 TANDEM AXLE TRAILER WEIGHT: 1,050 LBS.
 FUEL CAPACITY: 45 GALLONS
 CAPACITY: 10 PEOPLE OR 1,590 LBS.

- A OIL PRESSURE GAUGE
- B ENGINE TEMPERATURE GAUGE
- C MULTI-FUNCTION/TACHOMETER
- D CHECK ENGINE LIGHT
- E SPEEDOMETER OR PERFECT PASS
- F VOLTMETER
- G FUEL GAUGE
- H HORN
- I 12-VOLT RECEPTACLE
- J GAUGE DISPLAY SELECTOR
- K SPEEDOMETER CALIBRATOR
- L BLOWER SWITCH
- M IGNITION KEY SLOT
- N STEREO INSERT
- O ACCESSORY 1 SWITCH
- P ACCESSORY 2 SWITCH
- Q COURTESY LIGHTS SWITCH
- R NAVIGATION/ANCHOR LIGHT SWITCH
- S BILGE PUMP SWITCH
- T ACCESSORY

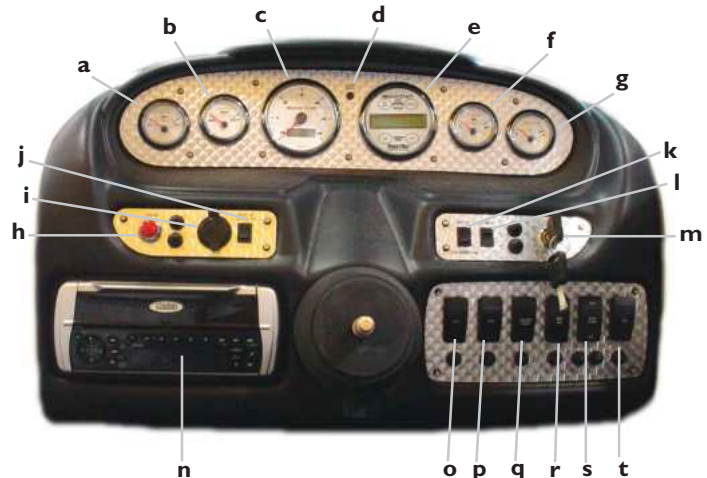

X-30

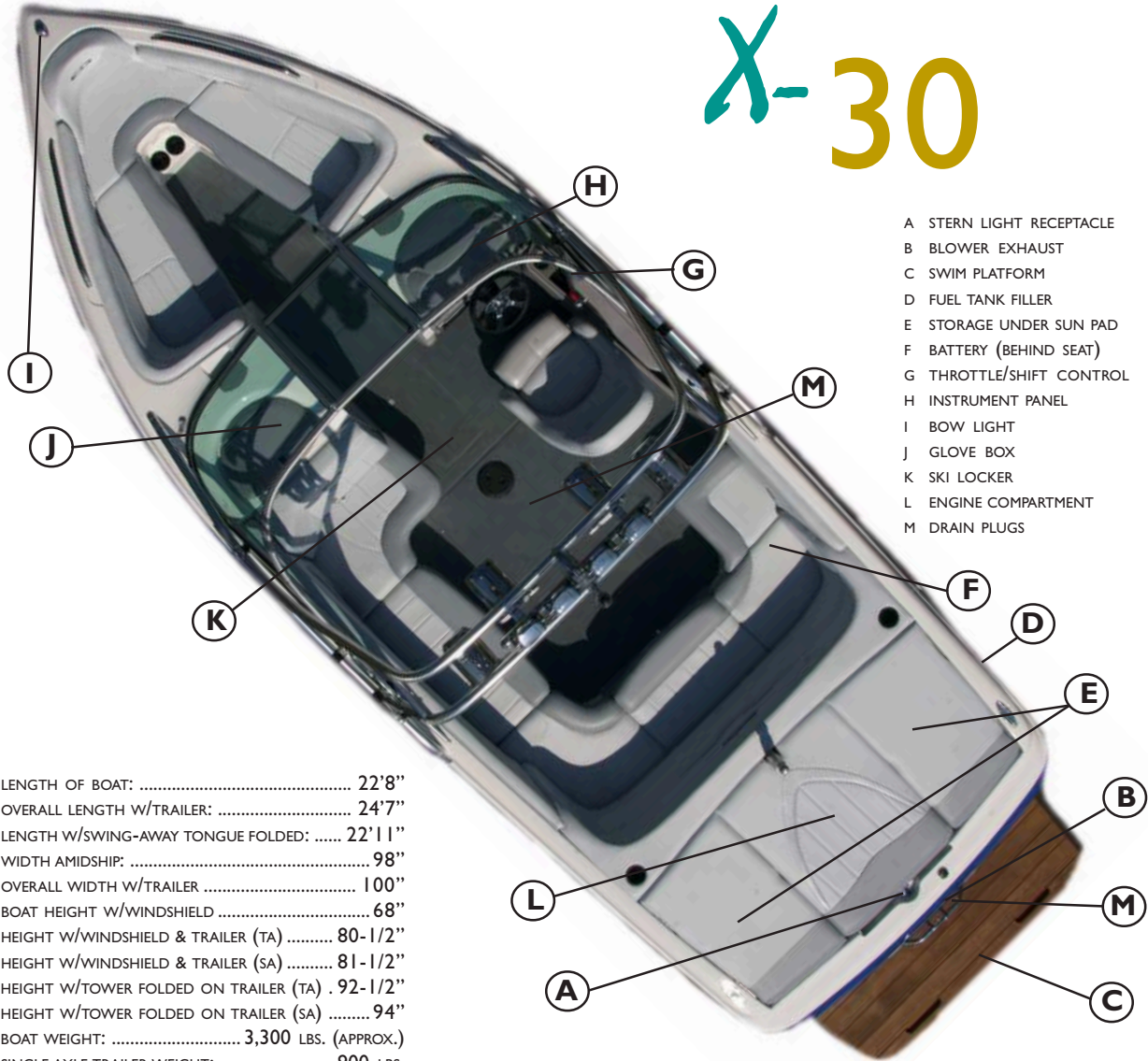

- A STERN LIGHT RECEPTACLE
- B BLOWER EXHAUST
- C SWIM PLATFORM
- D FUEL TANK FILLER
- E STORAGE UNDER SUN PAD
- F BATTERY (BEHIND SEAT)
- G THROTTLE/SHIFT CONTROL
- H INSTRUMENT PANEL
- I BOW LIGHT
- J GLOVE BOX
- K SKI LOCKER
- L ENGINE COMPARTMENT
- M DRAIN PLUGS

LENGTH OF BOAT: 22'8"
 OVERALL LENGTH W/TRAILER: 24'7"
 LENGTH W/SWING-AWAY TONGUE FOLDED: 22'11"
 WIDTH AMIDSHIP: 98"
 OVERALL WIDTH W/TRAILER 100"
 BOAT HEIGHT W/WINDSHIELD 68"
 HEIGHT W/WINDSHIELD & TRAILER (TA) 80-1/2"
 HEIGHT W/WINDSHIELD & TRAILER (SA) 81-1/2"
 HEIGHT W/TOWER FOLDED ON TRAILER (TA) . 92-1/2"
 HEIGHT W/TOWER FOLDED ON TRAILER (SA) 94"
 BOAT WEIGHT: 3,300 LBS. (APPROX.)
 SINGLE AXLE TRAILER WEIGHT: 900 LBS.
 TANDEM AXLE TRAILER WEIGHT: 1,050 LBS.
 FUEL CAPACITY: 60 GALLONS
 CAPACITY: 12 PEOPLE OR 1,840 LBS.

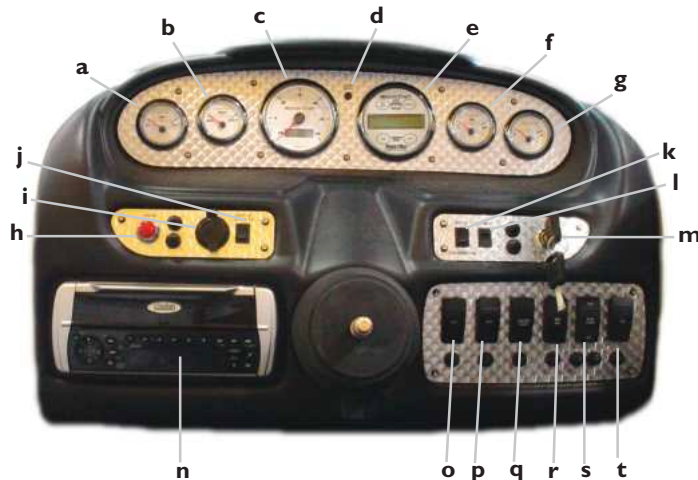

- A OIL PRESSURE GAUGE
- B ENGINE TEMPERATURE GAUGE
- C MULTI-FUNCTION/TACHOMETER
- D CHECK ENGINE LIGHT
- E SPEEDOMETER OR PERFECT PASS
- F VOLTMETER
- G FUEL GAUGE
- H HORN
- I 12-VOLT RECEPTACLE
- J GAUGE DISPLAY SELECTOR
- K SPEEDOMETER CALIBRATOR
- L BLOWER SWITCH
- M IGNITION KEY SLOT
- N STEREO INSERT
- O ACCESSORY 1 SWITCH
- P ACCESSORY 2 SWITCH
- Q COURTESY LIGHTS SWITCH
- R NAVIGATION/ANCHOR LIGHT SWITCH
- S BILGE PUMP SWITCH
- T ACCESSORY

X-STAR

- A BLOWER EXHAUST
- B SWIM PLATFORM
- C FUEL TANK FILLERS
- D BATTERIES
- E THROTTLE/SHIFT CONTROL
- F INSTRUMENT PANEL
- G BOW LIGHTS
- H ENGINE COMPARTMENT
- I DRAIN PLUGS

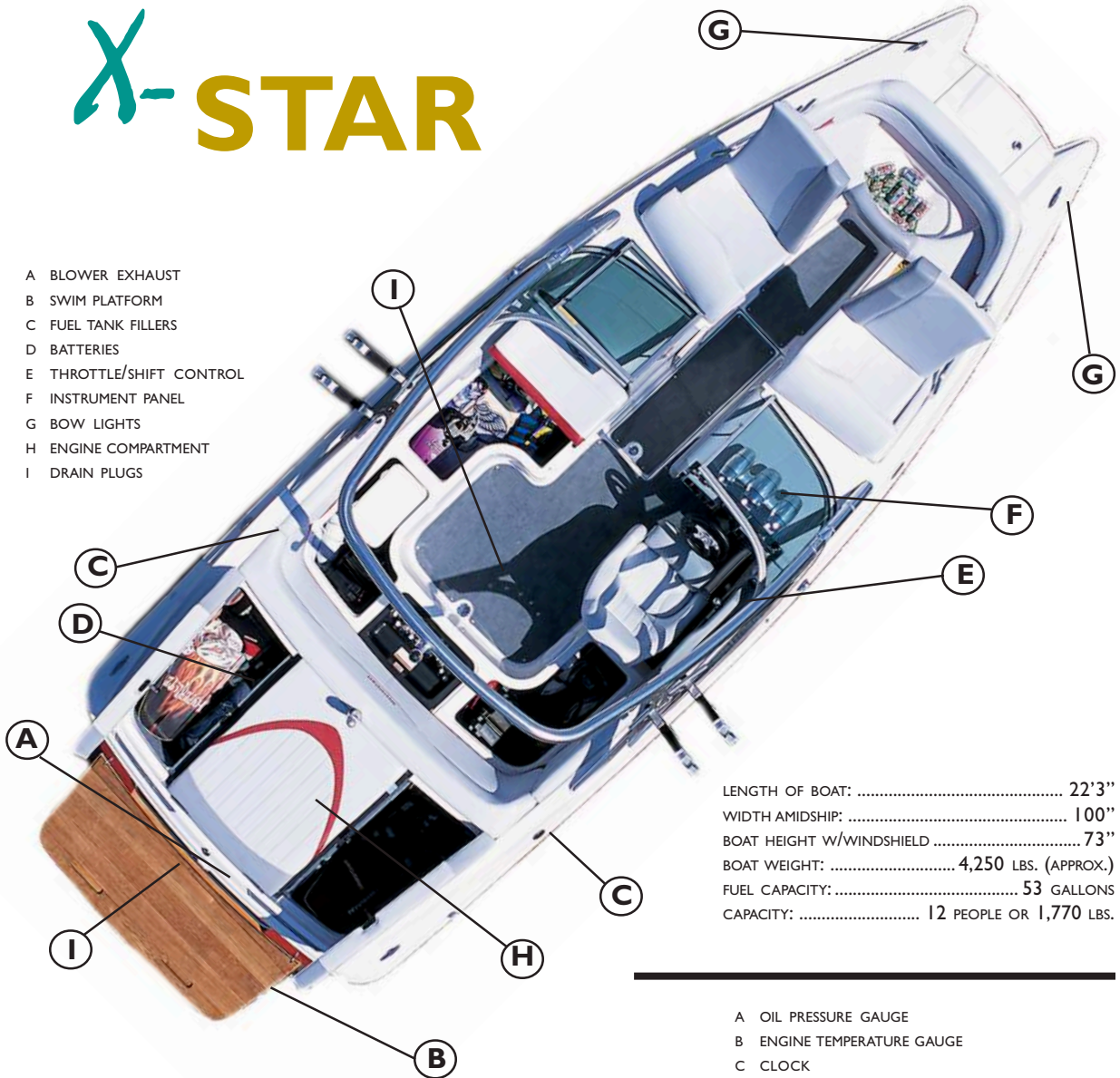

LENGTH OF BOAT: 22'3"
 WIDTH AMIDSHIP: 100"
 BOAT HEIGHT W/WINDSHIELD 73"
 BOAT WEIGHT: 4,250 LBS. (APPROX.)
 FUEL CAPACITY: 53 GALLONS
 CAPACITY: 12 PEOPLE OR 1,770 LBS.

- E SPEEDOMETER
- F PERFECT PASS GAUGE
- G VOLTMETER
- H DEPTH FINDER
- I FUEL GAUGE
- J HORN
- K CLOCK ADJUSTMENT SWITCH
- L SPEEDOMETER ADJUSTMENT SWITCH
- M COURTESY LIGHTS SWITCH
- N SHOWER SWITCH
- O HEATHER SWITCH
- P PORT BALLAST SWITCH
- Q KGB BALLAST SWITCH
- R STARBOARD BALLAST SWITCH
- S TOWER LIGHT SWITCH
- T TOWER LIGHT SWITCH
- U BLOWER SWITCH
- V BILGE SWITCH
- W NAV/ANCHOR LIGHTS SWITCH

- A OIL PRESSURE GAUGE
- B ENGINE TEMPERATURE GAUGE
- C CLOCK
- D TACHOMETER

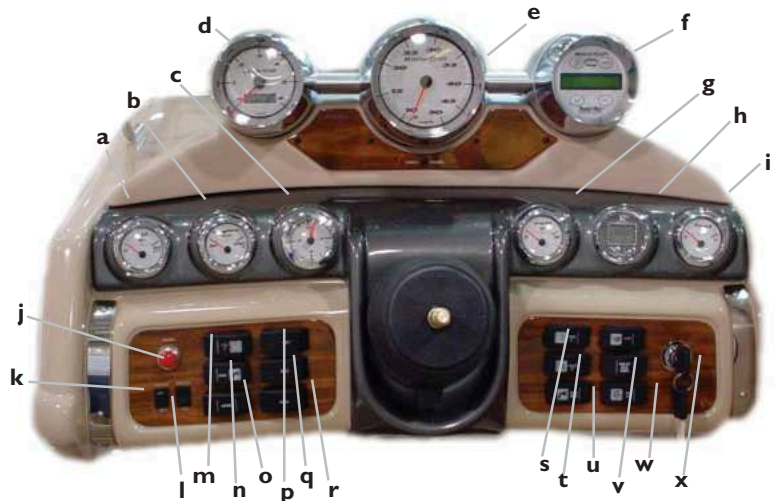

*MasterCraft Power Vortec
 Predator 5.7L EFI TBI 350-
 cubic-inch GM V-8 engine*

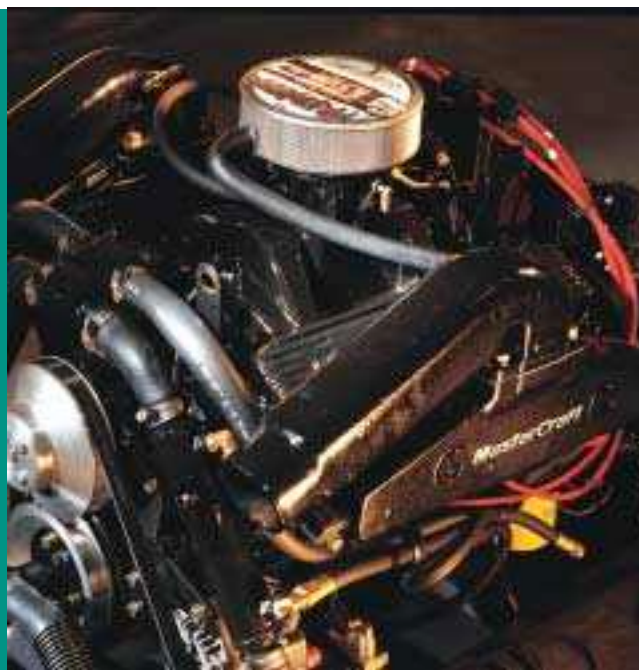

Displacement	350 C.I.D. (5.7 litres)—310 horsepower
Bore	4.00"
Stroke	3.48"
Compression Ratio	9.4:1
Compression Pressure	180-200 PSI
Maximum Allowable Compression Variation	Highest to lowest within 75%
Maximum Allowable RPM at WOT	4400-4800 RPM
Oil Pressure (Hot)	40 PSI at 2000 RPM
Propshaft Rotation	LH
Fuel Requirement	89 Octane
Fuel Pressure: Operating Pressure	20-30 PSI
Fuel Pump Volume	1 pint in 20 seconds
Type of Fuel Induction	Marine Electronic Fuel Injection Throttle Body Type
Electrical System	12 Volt
Ignition Type	Distributor HEI
Electronic Control Module	Delco Electronics Waterproof Marine Controller (M.E.F.I. 4)
Alternator Output Rating	70 amps at 2000 RPM
Thermostat	160 degrees
Spark Plug Type	ACMR43LTS
Recommended Plug Gap	0.045"
Firing Order	1-8-4-3-6-5-7-2
Minimum Battery Rating	750 cold cranking amps for 30 sec at 0 degrees Fahrenheit or better
Oil Capacity	4-5 quarts with filter change—verify with dipstick
Oil Type	SAE 15W40, CG-SJ4
Oil Filter Type	PF25 or PZ3
Transmission Fluid Capacity	1 ½ to 2 qts with 1:1 transmission; 2 ½ to 3 qts with 1.5:1 transmission
Initial Timing	10 degrees BTDC at 1000 fixed RPM
Total Ignition Advance	Varies as a function of input information
Cylinder Numbering Front to Rear	Left bank 1-3-5-7; Right bank 2-4-6-8



*MasterCraft Power Vortec
MCX 5.7L multi-port
EFI 350-cubic-inch
GM V-8 Engine*

Displacement	350 C.I.D. (5.7 litres)—350 horsepower
Bore	4.00"
Stroke	3.48"
Compression Ratio	9.4:1
Compression Pressure	180-220 PSI
Maximum Allowable Compression Variation	Highest to lowest within 75%
Maximum Allowable RPM at WOT	4800-5200 RPM
Oil Pressure (Hot)	40 PSI at 2000 RPM
Propshaft Rotation	LH
Fuel Requirement	89 Octane minimum
Fuel Pressure: Operating Pressure	35-45 PSI
Fuel Pump Volume	1 pint in 20 seconds
Type of Fuel Induction	Marine Electronic Fuel Injection Direct Port Type
Electrical System	12 Volt
Ignition Type	Northstar LSI multi-coil
Electronic Control Module	Delco Electronics Waterproof Marine Controller (M.E.F.I. 4)
Alternator Output Rating	70 amps at 2000 RPM
Thermostat	160 degrees
Spark Plug Type	AC MR43LTST
Recommended Plug Gap	0.045"
Firing Order	1-8-4-3-6-5-7-2
Minimum Battery Rating	750 cold cranking amps for 30 sec at 0 degrees Fahrenheit or better
Oil Capacity	4-5 quarts with filter change—verify with dipstick
Oil Type	SAE 15W40, CG-SJ4
Oil Filter Type	1 ½ to 2 qts with 1:1 transmission; 2 ½ to 3 qts with 1.5:1 transmission
Initial Timing	10 degrees BTDC at 1000 RPM fixed; factory set—not field adjustable
Total Ignition Advance	Varies as a function of input information
Cylinder Numbering Front to Rear	Left bank 1-3-5-7; Right bank 2-4-6-8

MasterCraft Power Vortec
Cadillac LQ9 HO 6.0L
multi-port EFI V-8 Engine



Displacement	279 C.I.D. (4.6 litres)—320 horsepower at 6000 RPM
Torque	318-lb-ft @ 4500 RPM
Bore	3.66"/93mm
Stroke	3.31"/84 mm
Camshafts	DOHC (4 valves/cyl)
Intake Valves	16 (1.30"/33 mm)
Valve Liters	16 (1.14"/29 mm)
Cylinder Head Material	Direct Acting Hydraulic
Block Material	Aluminum (Die Cast) w/cast iron liners
Combustion Chamber Volume	51.8 cc
Maximum Allowable Compression Variation	Highest to lowest w/in 75%
Maximum Allowable RPM at WOT	5800-6200 RPM
Oil Pressure (Hot)	35 PSI at 2000 RPM
Fuel Requirement	92 Octane (R+M)/2 (RFG acceptable)
Fuel Pressure: Operating Pressure	43-53 PSI
Fuel Pump Volume	1 pint in 20 seconds
Type of Fuel Induction	Marine Electronic Fuel Injection Phased Port Type
Electronic Control Module	Delco Electronics Waterproof Marine Controller (MEFI 3/CEFI 3)
Ignition System	Northstar Multi-Coil LSI
Alternator Output Rating	51 amps at 2200 RPM
Thermostat	160 degrees
Spark Plug Type	AC 41-950
Recommended Plug Gap	0.050"
Firing Order	1-2-7-3-4-5-6-8
Minimum Battery Rating	750 cold cranking amps for 30 sec at 0 degrees Fahrenheit or better
Oil Capacity	7.5 quarts with filter change (8.5 w/cooler)—verify with dipstick
Oil Type	SAE 15W-40, CG-SJ4
Oil Filter Type	PF 58
Transmission Fluid Capacity	2 ½ to 3 qts with 1.5:1 transmission or V-drive transmission
Initial Timing	Factory-set and computer-controlled—not field adjustable
Total Ignition Advance	Varies as a function of input information
Cooling System—Engine	Full Fresh Water (closed) 12 qt. 50/50 Propylene Glycol & Water
Cooling System—Engine Oil/Transmission	Raw Water—Full Flow Tandem
Pump Capacity—Raw	25 GPM
Pump Capacity—Circulating	104 GPM
Propshaft Rotation	LH
Cylinder Numbering Front to Rear	Left Bank 2-4-6-8; Right bank 1-3-5-7

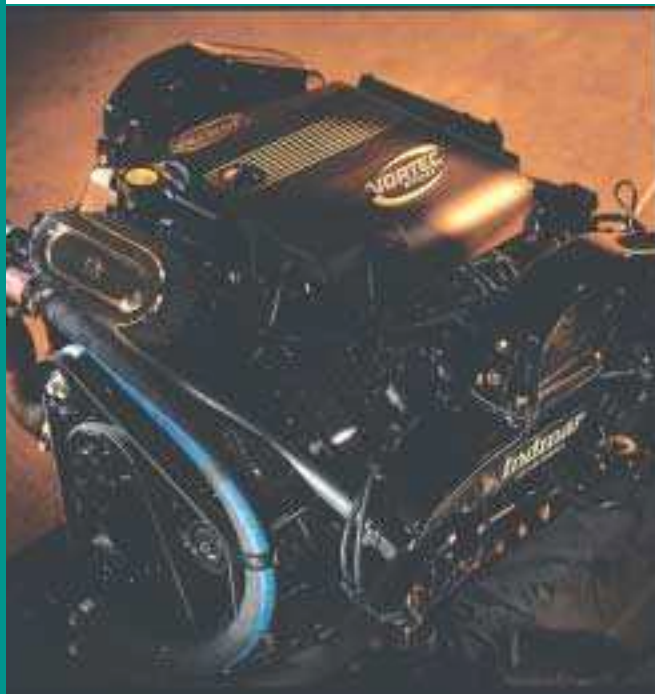

MasterCraft Power Vortec

L18 HO 8.1L EFI

496-cubic-inch GM

V-8 Engine

Displacement	496 C.I.D. (8.1 Litres)—425 horsepower
Bore	4.25"
Stroke	4.37"
Compression Ratio	9.1:1
Compression Pressure	180-200 PSI
Maximum Allowable Compression Variation	Highest to lowest within 75%
Maximum Allowable RPM at WOT	5400 RPM
Oil Pressure (Hot)	10 PSI minimum at 2000 RPM
Propshaft Rotation	LH
Fuel Requirement	89 Octane
Fuel Pressure: Operating Pressure	TBD
Fuel Pump Volume	TBD
Type of Fuel Induction	Marine Electronic Fuel Injection Direct Port Type
Electrical System	12Volt
Ignition Type	Northstar Multi-Coil LSI
Electronic Control Module	Delco Electronics Waterproof Marine Controller (M.E.F.I. 4)
Alternator Output Rating	70 amps at 2000 RPM
Thermostat	160 degrees
Spark Plug Type	Denso TJI4R-P15
Recommended Plug Gap	0.050"
Firing Order	1-8-7-2-6-5-4-3
Minimum Battery Rating	750 cold cranking amps for 30 sec at 0 degrees Fahrenheit or better
Oil Capacity	8 quarts with filter change—verify with dipstick
Oil Type	SAE 15W-40, CG-SJ4
Oil Filter Type	PF454
Transmission Fluid Capacity	4 quarts with V-drive transmission; 2 ½ to 3 quarts with 1.5:1 transmission
Initial Timing	10 degrees BTDC at 1000 fixed RPM; Factory Set—Not Field Adjustable
Total Ignition Advance	Varies as a function of input information
Cylinder Numbering Front to Rear	Left Bank 1-3-5-7; Right bank 2-4-6-8

Shaft and Propeller Combinations

MasterCraft

Boat	Engine	Transmission	Shaft	Propeller
ProStar 190 & 197, X-7	TBI	1:1	49"x1 1/8"	13"x14"
ProStar 190 & 197, X-7	TBI	1.5:1	51"x1 1/8"	14"x20"
ProStar 190 & 197, X-7	MCX	1:1	49"x1 1/8"	13"x13"
ProStar 190 & 197, X-7	MCX	1.5:1	51"x1 1/8"	14"x18"
ProStar 190 & 197, X-7	6.0L	1:1	49"x1 1/8"	13"x14" SS
ProStar 190 & 197, X-7	8.1L	1.5:1	48 1/8"x1 1/8"	14"x20" SSI
ProStar 209, X-9	TBI	1:1	47 1/2"x1 1/8"	13"x14"
ProStar 209, X-9	TBI	1.5:1	49 1/2"x1 1/8"	14"x20"
ProStar 209, X-9	MCX	1:1	47 1/2"x1 1/8"	13"x13"
ProStar 209, X-9	MCX	1.5:1	49 1/2"x1 1/8"	14"x18"
ProStar 209, X-9	6.0L	1:1	47 1/2"x1 1/8"	13"x14" SS
ProStar 209, X-9	6.0L	1.5:1	47 1/2"x1 1/8"	14"x20" SS
ProStar 209, X-9	8.1L	1.5:1	45 1/2"x1 1/8"	14"x20" SSI
X-2	TBI	1.5:1	52 1/2"x1 1/8"	14"x20"
X-2	MCX	1.5:1	52 1/2"x1 1/8"	14"x18"
MariStar 210, X-10	TBI	1.5:1	52 1/2"x1 1/8"	14"x20"
MariStar 210, X-10	MCX	1.5:1	52 1/2"x1 1/8"	14"x18"
MariStar 210, X-10	6.0L	1.5:1	52 1/2"x1 1/8"	14"x20" SS
MariStar 210, X-10	8.1L	1.5:1	52 1/2"x1 1/8"	14"x20" SS
MariStar 230, X-30	TBI	1.5:1	52 1/2"x1 1/8"	14"x20"
MariStar 230, X-30	MCX	1.5:1	52 1/2"x1 1/8"	14"x18"
MariStar 230, X-30	6.0L	1.5:1	52 1/2"x1 1/8"	14"x20" SS
MariStar 230, X-30	8.1L	1.5:1	52 1/2"x1 1/8"	14"x20" SS
MariStar 280VLD	6.0L	1.5:1	52 1/2"x1 1/8"	14"x20" SS
MariStar 280VLD	8.1L	1.5:1	52 1/2"x1 1/8"	14"x20" SS
X-Star	TBI	1.5:1	52 1/2"x1 1/8"	14"x20"
X-Star	MCX	1.5:1	52 1/2"x1 1/8"	14"x18"
X-Star	6.0L	1.5:1	52 1/2"x1 1/8"	14"x20" SS
X-Star	8.1L	1.5:1	52 1/2"x1 1/8"	14"x20" SS

Controls and Indicators

While the **Model Specifications** pages provide specific information regarding the location of individual gauges and switches for each MasterCraft model, there is some general information about various gauges that has a direct impact in the operation and maintenance of your boat. The following includes information that should be reviewed and recalled on a regular basis.



Multi-Function Gauge

Beginning with the 2004 model year, this gauge provides several functions of interest and support to the boater. As a **tachometer**, it indicates the engine speed in crankshaft revolutions per minute (RPM). Propeller shaft RPM is the same as the engine rotation except for boats equipped with the Power Slot 1.5:1 ratio package or a V-drive gear, in which case propeller shaft RPM is less than that of the engine RPM.

Toggle to the **hourmeter** and it registers the accumulated engine operating time. Use the hourmeter to keep accurate logs for scheduled maintenance.

Toggle to the **depth finder** to determine the approximate depth from the bottom of the hull to the ground surface beneath the water.

Toggle to the **air temperature gauge** to get an approximate reading of the ambient air temperature above the water's surface.

Toggle to the **clock** for the convenience of determining the time.

(See the adjacent box for additional information about using this gauge.)



Fuel Gauge

The readings are only approximate. The gauge is activated with the ignition switch. Rocking motion of the boat during normal operation will cause fluctuation of the fuel gauge. For a more accurate reading, make sure that the boat is level and at rest. When the boat is placed into initial operation, do not run the boat below a quarter of a tank until you have refueled several times and have a sense of how long you can operate the boat on the fuel available. Extending usage beyond the known capability may cause the boat to run out of fuel and strand you away from the shore.



Making Use of the Multi-Function Gauge

In addition to the displays noted to the left, the multi-function gauge also displays several alarms. The following messages will be displayed if an alarm occurs:

VOLT = Below 11.5 volts

OIL = Oil is below 4 p.s.i. when the R.P.M. is below 1000 R.P.M. or the oil pressure is below 10 p.s.i. and above 1000 R.P.M.

TEMP = High engine temperature alarm

TRAN = Transmission alarm

The **hourmeter** displays the boat hours and is stored in the engine's computer. Replacing the computer (known as an MMDC) will erase the hours. It counts hours only when the engine is above 300 R.P.M. When equipped with a revision C MMDC, the option exists to change the display to metric from the hours screen. This is done by holding down the gauge selection display button for three seconds. When prompted, select English or metric display. Wait an additional three seconds and the display will return to normal operation.

The **clock** can be adjusted by depressing the gauge selection display button when the clock is displayed. After three seconds the colon will stop flashing and the *hours* are adjusted by pressing *down*, while *minutes* are adjusted by pressing *up*. After three additional seconds the clock will return to normal operation.

Lake temperature is also standard on the gauge. This comes from the paddle wheel located under the boat. If the sensor becomes open or shorts-out to the battery, it will read 32° F. If the sensor is shorted to ground it will read 150° F. The temperature is also where the **SELF TEST** is located. With the lake temperature displayed, hold down the gauge selection display button for three seconds or until the self test has started. During the self test, all the segments on the display will light up. Also during the self test, the gauges will re-set, go to mid-scale and then to full-scale. After two sweeps the system returns to normal.

Although it may be possible to see fuel in the bottom of the fuel tank, you still may not be able to operate the boat. The fuel pick-up system was designed to avoid introducing the water and debris that inevitably accumulate in the bottom of the tank. Rather than relying on visual inspection, you should pay attention to the fuel gauge.



Temperature Gauge

The temperature gauge indicates the cooling water temperature inside the engine as measured in degrees Fahrenheit.

The normal operating temperature will range from 140 degrees to 190 degrees. Engines with electronic fuel injection also have a control circuit inside the engine control module that will cause the engine to run at reduced speeds if the module senses that the engine is running too hot. If you notice that your speed has reduced during normal operation without reducing the throttle, monitor your temperature gauge. If the gauge indicates excessive temperatures during operation, slow down immediately and turn off the ignition. **This indicates an engine problem that needs to be checked by the dealer!**



Check Engine Light

The red malfunction indicator *Check Engine* light is operated from an on-board computer that monitors the operation of your fuel, ignition and engine control systems.

On some models, the *Check Engine* light should come on when the key is in the ON position and the engine is not running. This is a check to show you that it is working. If it does not come on at all, have it repaired by your MasterCraft dealer right away.

If it stays on—or comes on while you are operating your boat—the computer is indicating that you have a problem. You should take your boat to your MasterCraft dealer for immediate service.

Notice: If you continue to operate your boat with this light on, you could adversely affect the emission control systems on the engine. You could also experience poor fuel economy, and your engine may not run as smoothly. This could lead to costly repairs not covered by your warranty.

Low Voltage Battery Alarm

In the event that the stereo has been functioning when the boat is not ON and running, the voltage



Continuing to operate the boat while the temperature is above normal operating parameters may cause serious damage to your engine. Damage to your engine resulting from operating the engine in an overheated condition can be costly to repair. Such damage is not covered by your warranty!

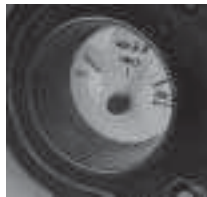

Engine Oil Pressure Gauge

The engine oil pressure gauge indicates the pressure of the lubricating oil inside the engine. The average pressure ranges are between 6 pounds-per-square-inch (PSI) at 1000 RPM to 40 PSI or

more at cruise-range speeds. A reading of pressure below 5 PSI at 1000 RPM may be caused by a low oil level or other potentially serious problems that result in low oil pressure. If you experience low oil pressure, stop your engine immediately and check your oil level before operating again.

drain on the battery can result in difficulties in restarting the boat. It can also cause intermittent erroneous or fluctuating gauge readings. To avoid this situation, when the voltage level reaches 11.5 volts, the system will shut off the stereo system and sound the alarm for a period of two minutes to give boaters ample time to adjust.

Other Alarms

Sensors check the oil pressure, engine and transmission temperatures. If the system detects readings outside the acceptable range, the system shuts off the stereo (if ON) and sounds the alarm for a period



Do not continue to run the engine if the oil pressure is low. If you do, the engine can become so hot that it—or surrounding components—could catch fire. You or others could be burned and the boat seriously damaged. Check your oil level and add an appropriate amount of approved motor oil before operating again or have your boat serviced by your local MasterCraft dealer. Note that damage to your engine from neglected oil problems can be costly to repair. Such damage is not covered by your warranty.

of one minute. Even after the alarm ceases, the *Check Engine* light will remain on.

This signals the need to return to shore and seek assistance from your dealer as soon as possible to diagnose and, if necessary, repair the issue.

Ignition Switch

Never leave the ignition switch in the RUN position without the engine running; this will prevent the natural discharge of the battery and result in damage to the starter solenoid.

Safety Switch

The emergency engine safety switch, called the lanyard, is an ignition cut-off switch designed to stop the engine in the event of an operator being thrown from position or moving too far from the helm.

The lanyard is equipped with a hook on one end for attachment to your clothing or PFD, and the opposite end has a slide that fits over the switch. Be sure that the slide is firmly attached to the switch before starting. The switch is located on the throttle control box. If the slide is left off or loose, the engine will crank but will not start.



DANGER

The safety switch lanyard must be attached to the operator whenever the engine is started. Failure to do so may result in serious injury or death.

Blower Switch

A two-position rocker switch activates the engine box ventilation blower. Push the top half of the switch to turn the blower ON.

NOTE: The blower must operate for a minimum of four (4) minutes before starting the engine at any time. The blower must also be operated during idle and slow-speed running, but is not necessary at cruising speed.



DANGER

Failure to operate the blower as instructed could cause improper ventilation of the boat engine and bilge areas. Fuel vapors can accumulate in this area and cause a fire or explosion which may result in serious injury or death!

Manual and Automatic Bilge Pump Switch

A three-position rocker switch activates the bilge pump. Push the top half of the switch to turn the bilge pump to the manual ON position. Press the

switch down to activate the bilge pump for automatic mode while the boat is underway. When the switch is centered, the bilge pump is OFF. The bilge pumps on all V-drive models will be in the automatic mode when the ignition key is turned ON.

Ballast Pump Switch

On boat models equipped with a ballast system, a three-position switch will allow for the filling or emptying of the ballast tanks and/or bags. It is important to be aware that the engine must operate at 1500 RPM during the fill and empty processes. Failure to do so can result in malfunction or permanent damage to the ballast pumps that force the water through the system. This is not covered under warranty.

Circuit Breakers

All major boat circuits are protected from shorting and overload by re-settable circuit breakers. If a problem develops with one of the following circuits, switch OFF the circuit and wait about one minute. Then push the appropriate breaker button fully and switch ON the circuit. If the circuit continues to trip, there is a

problem somewhere that must be attended to immediately. See your MasterCraft dealer.

The location of the main circuit breaker board is under the dash panel. In some models, there is an additional breaker panel to assist with the accessory load, and it is located near the battery box. There may also be a waterproof fuse for the stereo amplifier, where equipped. If the boat's accessories are not functional, check and re-set breakers as necessary.

The engines are also equipped with breaker systems. The main 50A circuit breaker protects the engine electrical system and components from overload.

If the engine will not turn over with the battery



TOP: The breaker panel is located under the dash panel. BELOW LEFT: The additional accessory breaker on later ProStar and MariStar models is located near the battery box also. LOWER RIGHT: The waterproof fuse shown is used for the stereo amplifier.

switch in the ON position, locate the red breaker re-set button (labeled “50”) in the engine.

Firmly push the red button until the breaker re-sets. There will be an audible click. Try again to start the engine. If the breaker trips again, the engine requires attention. Take your boat immediately to your dealer.

In addition to the 50A circuit breaker, the engines are also equipped with additional component overload protection, including a 15A ATO fuse for the fuel pump, a 15A ATO fuse for the injectors and a 15A ATO fuse for the ECM unit.

If you suspect that any of these fuses may not be operating as designed, you should take your boat to your dealer for attention.

If during maintenance or inspection it becomes necessary to remove or re-position any of the engine’s wiring or wire harness(es) verify that the wiring has been returned to its original position and that all harnesses are routed correctly before attempting to use the boat again. If a wiring clip or retainer breaks, replace it immediately. Wiring is specifically routed to eliminate problems related to engine heat and spray or immersion in liquids. Electrical problems can result if wiring is moved from the original position!



Shift/Throttle Control

A one-hand, single-lever control operates as both a gear shifter and a throttle. The lever automatically locks in the neutral position (*straight up and down*) for safety. The lever can be moved from neutral only by raising the lifter under the ball knob. Shifting is accomplished by moving the lever into the first 45 degrees of travel.

Moving the lever forward engages the running gear; moving it back from center puts the drive train into reverse. By advancing the lever beyond 45 degrees you move from the shifting range to the throttle range.

Never attempt to shift without the engine running!

The shift mechanism of this control can be temporarily disengaged by engaging in the black button in the side of the throttle handle. This allows the engine to increase RPM in neutral during warm-up.

Fueling

The ignition timing as set by the factory requires the use of unleaded fuel with an Anti-Knock Index Number (AKI)/Pump Octane Number range between 89 octane and 93 octane. Nearly any medium-grade gasoline available for automotive use may be used.

CAUTION

Damage to the engine by use of low-quality gasoline or gasoline with an octane rating below the minimum level listed will void the warranty on your boat.

Fuel Systems

The ProStar and MariStar models are equipped with a new, highly innovative fuel system. This system is designed to provide you with years of trouble-free service. Some of the latest innovations related to fuel handling safety are also incorporated into the fuel delivery system.

The system uses a fuel pump mounted in a capsule that is installed directly in a fuel tank. A similar system has been used in automotive vehicles for over a decade and has provided years of proven service. The pump system in your boat was specifically designed for the marine environment and contains a number of added safety components that are unique to the marine system. Because of the special nature of the design, there are no user-serviceable parts. Any parts in need of service or maintenance will need to be addressed by your MasterCraft dealer. The technical team there is equipped with the *special tools needed to disassemble and service the fuel capsule and associated parts*.

The fuel line that travels in the boat's bilge area from the tank to the engine is a special multi-layer armored line that is covered with a special material known as a fire sleeve. The fire sleeve affords protection to the fuel line in the unlikely event of a boat fire.

The sleeve is colored orange in order to afford easy identification to the fuel line. MasterCraft recommends daily inspection of the bilge for foreign materials and the possibility of gas or oil leakage detection. As part of your daily inspection, include a visual check of the orange fire-sleeved fuel line. If you see damage to the sleeve or line—or in any way suspect damage or fuel leakage, **DO NOT START YOUR BOAT!** Immediately call your MasterCraft servicing dealer and let him or her assess the situation.

Fuel Systems for 19 Skier and Older ProStar and MariStar Models

The 2004 models are equipped with a pump-in-



tank fuel module that has an internal check-valve system, and therefore does not require a shut-off valve. In the SportStar 19 and older ProStar and MariStar models, however, the fuel system features an ON-OFF valve.

If at any time a fuel line leak is detected in one of these boats, turn OFF the fuel valve, which is located on the fuel tank, to stop the fuel supply flow. Immediately contact your dealer for proper repair.

Alternatives and Additives

We do not recommend that you use alcohol-modified fuels in your MasterCraft boat because of the following side effects:

- **Moisture:** Alcohol-blended fuels absorb and keep moisture. Moisture inside the fuel tank causes many engine problems.
- **Performance:** Alcohol-blended fuels cause the engine to operate on a leaner fuel/air ratio and may cause hard starting, stalling and vapor lock. Engine damage may result.
- **Deterioration:** Alcohol quickly deteriorates rubber and plastic components in the fuel system, causing more frequent inspection and replacement of parts. This increases the potential for fire and explosion due to fuel leakage. The new fuel system, however, is designed to withstand alcohol and MTBE fuel additives commonly found in the new “oxygenated” fuels. We still recommend fuels with as little alcohol as possible due to the moisture absorption problem identified above.

NOTE: Fuel additives and treatments, other than conditioners for moisture absorption and winter storage are not recommended for use in MasterCraft Power engines.

Using Oxygenated Fuels or Fuels with Alcohol

MBTE (methyl butyl tertiary ether) is an oxygenate and octane enhancer. This compound is blended with fuel in some parts of the country. Fuel that is no more than 15% MBTE is acceptable for use in your engine. Ethyl alcohol or grain alcohol is acceptable for use as long as it is a blend and the blended fuel contains no more than 10% ethanol.

Type of Gasoline to Use

Gasoline should meet the specifications ASTM D4814 in the United States and CGSB 3.5-92 in Canada.

If you operate your engine in a country other than the United States or Canada, unleaded fuels may be difficult to locate. Using leaded fuels in your engine is not recommended as engine components will last longer using unleaded fuel. (Leaded fuel is not compatible with today's engines.)

When a Boat Does Not Run for a While

The engine manufacturer recommends the use of a stabilizer such as Sta-Bil® fuel stabilizer for boat users who consume less than a tank of fuel every two weeks. Today's fuels are more susceptible to degradation and the use of a quality stabilizer will help ensure fewer problems for the occasional boater.

If your boat has not been used for more than 30 days during which fuel remained in the tank (even stabilized fuel), the engine may run poorly until the “old” fuel is used up. Engine parts and fuel injection components rendered inoperable or damaged from old and/or poor-quality fuel will not be covered under warranty!

Always tighten the fuel plate cap completely with the cap key after refueling.

CAUTION

Fuels that are blended to contain methanol or wood alcohol are not to be used in MasterCraft engines. These fuels can corrode some metal parts in your fuel system and engine. Damage caused by the use of unapproved fuels is not covered by warranty.

DANGER

Gasoline is extremely flammable and highly explosive under certain conditions. Always stop the engine and never smoke or allow open flames or sparks within 50 feet of the fueling area when refueling.

CAUTION

Extended storage with fuel in the system can affect the fuel's stability and may require system inspection and fuel filter replacement when the unit is placed back into service.

DANGER

Take care not to spill gasoline. If gasoline is spilled accidentally, wipe up all traces of it with dry rags immediately and properly on shore.

Safety Checks and Services

The following checks and services are essential to safe boating and must be performed. Get in the habit of performing these checks in the same order each outing so that it becomes routine.



WARNING

DO NOT launch or operate the boat if any problem is found during the Safety Check. A problem could lead to an accident during the outing, resulting in serious injury or death. Any and all problems should receive attention immediately. See your MasterCraft dealer for assistance.

Before Each Operation

These tasks are best accomplished before the boat is launched.

- ✓ Check the weather report, wind and water conditions.
- ✓ Check for recommended on-board tools and parts.
- ✓ Check that all drain plugs are installed properly, including bilge and rear drain.
- ✓ Check the propeller and shaft for damage.
- ✓ Check the cooling water intake pick-up and transmission cooler for blockage. *(Additional details on this will follow in the Scheduled Maintenance Checks and Service Section.)*
- ✓ Check the raw water impeller if the boat showed signs of over-heating during the last usage.
- ✓ Check the engine oil level.
- ✓ Check that there is an adequate supply of fuel.
- ✓ Check that the steering system operated properly.
- ✓ Check that required safety equipment is on-board.
- ✓ Check that the mandatory personal flotation device for each passenger is on-board.
- ✓ Check that fire extinguisher is fully charged.
- ✓ Check that no fuel, oil or water is leaking or has leaked into the bilge component.
- ✓ Check all hoses and connections for leakage or damage.
- ✓ Check that the alternator belt is in good condition.
- ✓ Check the engine drain plugs.
- ✓ Check that all required **Scheduled Maintenance Checks and Services** (see following sections) were performed.

During Operation

- ✓ Check gauges frequently for operating conditions.
- ✓ Check that controls operate smoothly.
- ✓ Check for excessive vibration.

After Operation

- ✓ Check for fluid leaks.
- ✓ For models equipped with a main fuel valve, turn it to the OFF position.
- ✓ Check the fins, propeller, rudder and shaft for damage after removing the boat from the water.
- ✓ In boats equipped with a ballast system, drain water from the ballast.



New Boat Break-In

Note: Failure to follow the break-in procedure exactly as stated will void the engine warranty.

The first 20 hours of operation are the most important to your boat. Proper break-in will ensure maximum performance and the longest possible power train life. The break-in period allows moving parts within the engine and transmission to wear-in properly. All MasterCraft boats are lake-tested on the water before leaving the factory, but the break-in must continue for the first 20 hours of your ownership.



Note: Before operating the boat for the first time, you must read this manual completely.

CAUTION

To ensure proper break-in and lubrication, boat owners should not remove the factory break-in oil until after the initial ten (10) hours of operation. At that time, an oil change should be performed by an authorized MasterCraft service technician/your local MasterCraft dealer.

Please follow the break-in procedure carefully. Close attention to the following is very important:

- **Maintain the proper oil level.** Until the piston rings, cylinder and other working internal parts are thoroughly seated, oil consumption can be high and must be carefully watched. The oil requirement is for SAE 15W40, AP SJ/CH4. If the specified oil is not available, 20W40 oil may be substituted by only if it meets the API SJ/CH4 standards.
- **Pay close attention to the gauges.** It is important to stop the engine immediately if the gauges indicate a problem. Low oil pressure and overheating are serious issues and require immediate attention.
- **Abnormal vibration or noises.** These symptoms can precede trouble and should not be ignored. Occasionally, hardware may work loose, mountings may need tightening or the driveline may require attention.
- **Fuel, oil or water leaks.** Leaks can pose a serious safety threat. If one occurs, it is most likely to do so after a few hours of operation.
- **Vary the engine speed.** Never run the engine for more than three (3) minutes at any constant RPM during the break-in period. Doing this will assist in the proper break-in of rings and bearings.
- **Plane the boat quickly.** Operating the boat at low speeds places an excessive load on the engine. Plane quickly, then back down to a slower planing speed.



First Hour of Operation

Start the engine and allow the warm-up to normal operating temperature (140 degrees F to 190 degrees F) at low idle (600 to 800 RPM).

Operate the boat in forward gear, accelerate quickly, but gradually, to planing speed. Then return the throttle back to maintain a planing attitude. Vary the engine speed, but do not exceed 2000 RPM for the first hour. Carry only a light load.

Next Five Hours of Operation

Continue operation at plane and vary the engine speed, but do not exceed 4000 RPM. Occasionally reduce the throttle to idle speed for a cool-down period. Carry only a light load.

Next Ten Hours of Operation

Operations during the final ten hours of break-in is very much the same as the second five hours, except that it is permis-

sible to run at full speed for 2-3 minutes at a time. Do not accelerate suddenly from low-to-full speed. Increase speed gradually during this period. Again, an occasional cool-down period is recommended.

After the First 10 Hours of Operation

Return the boat to your MasterCraft dealer for the 10-hour inspection. At this time, your service technician should change the engine oil and filter, as well as making other necessary checks, adjustments and services. **The oil change is particularly critical to long life and good service from your engine!**

After Break-In

Once the break-in period is over, the boat may be operated continuously at any speed, but not beyond the maximum. For the Predator engine that is 4800 RPMs; the MCX is 5200 RPMs, the LQ9 Cadillac is 5400 RPMs, and the 8.1 Liter engine is 5400 RPMs as well.

Always remember that during normal operation you should allow the engine to warm up gradually. Be sure the engine is warm before accelerating. Pay careful attention to the gauges and the Check Engine indicator. Also, check the oil level frequently during the first 50 hours of operation since the piston rings and cylinders will require that period to seat properly.

After the initial 50 hours of operation, the engine oil and filter must be changed. **This second oil change is very important to ensure a long and trouble-free engine life.**

(Note that the engine manufacturer does not recommend using synthetic oils until at least 100 hours.)

After break-in, all maintenance is performed at regular intervals.

See the Scheduled Maintenance Checks and Services section for more details.

CAUTION

Failure to follow the engine oil recommendation listed in the manual can cause additional engine wear and increase the possibility of engine component failure. Damage to your engine due to incorrect oil usage can be costly to repair, and is not covered by your warranty!

Starting and Basic Operation

Note: If you are operating this boat for the first time, you must follow the New Boat Break-in procedures as described in the previous section. Failure to follow these procedures could result in serious engine damage and would void your warranty!

Before Starting

Familiarize yourself with the controls and indicators used on your MasterCraft boat. Perform all **Safety Checks and Services** as described earlier. Perform all **Scheduled Maintenance Checks and Services** also.

Step 1: Lift the engine cover and inspect the bilge and engine compartment for any fluid leakage. We recommend lifting the engine compartment cover for inspection before each use.



Step 2: Operate the bilge blower for at least four (4) minutes. Leave the bilge blower ON through the starting process and until the boat has planed. Check the hull drain plugs: Make sure they are installed and secure.



DANGER

To prevent a possible explosion, operate the blower for at least four (4) minutes before starting the engine and always when at idle or slow-running speed. Explosive gasoline and/or battery fumes may be present in the engine compartment. Failure to do so may result in serious injury or death!

Step 3: If your boat is a SportStar 19 or a pre-2000 model ProStar or MariStar and is not equipped with in-tank fuel pump, turn the fuel valve to the ON position.



DANGER

Before starting the engine, open the engine compartment and check for gasoline fumes, fuel and oil leaks or the presence of fuel or oil in the bilge.

Note: Always start the engine with the control lever in the neutral position or with the shift disengaged. Your boat is equipped with a neutral-start safety switch that will not allow the engine to be started in gear. On EFI engines, if the engine floods, it can be cleared by pushing the button that is in the throttle arm and advancing the throttle to full open—100 percent of its travel—and turning the key switch to the start position. The ECM shuts off the fuel supply to the injectors so that no fuel will be delivered during the cranking cycle. When the engine starts, immediately return the throttle to the idle position so that the engine will not over-rev.

Starting the Engine

Step 1: Attach the emergency engine safety switch tether (lanyard) between an article of your clothing and the switch.

Step 2: For normal starting, leave the throttle lever in neutral. The electronic controls will meter the correct fuel and air automatically.

Step 3: Turn the key switch to the start position and hold until the engine starts. Release the key as soon as the engine starts. If the engine does not start within 10-15 seconds:

- a) Pull out the neutral detent.
- b) Advance the throttle lever to wide-open throttle and crank the engine. When the engine fires, quickly return the throttle to the idle position.

CAUTION

Do not operate the starter motor continuously for more than fifteen (15) seconds without at least a two (2) minute “cool-down” period. Failure to do so may cause the starter to overheat, resulting in damage. Failure to release the ignition key after the engine has started may cause damage to the starter motor and drive.

Note: While the engine is warming up, check to see that all lights and gauges operate properly, as well as the steering. There should be no apparent leaks under pressure. Re-engage the control lever after warm-up by returning the lever to neutral and pushing the throttle button back into the engage position.

Step 4: Always allow the engine to warm up to normal operation temperature before accelerating. EFI engines, including all late-model MasterCraft engines, are programmed with a phased warm-up to ensure that the engine is warm before full RPM is possible.

103°F (40°C) or less: 3,000 RPMs

104° to 139°F (41° to 59°C) at least 10 seconds after starting: 4,200 RPM

140° (60°C) and higher, at least 10 seconds after starting: Full RPM

Shifting Gears

When shifting, always move the control lever smoothly and quickly into gear. Do not hesitate. Slow gear engagement could damage the shifting mechanism in the transmission. Always allow the engine speed to fall to low idle (600-800 RPM) before making a gear shift.

Forward: Raise the lifter ball under the lever knob and then push the control lever forward into the first 45 degrees of travel. Throttle movement will begin after 45 degrees.



Reverse: Raise the lifter ball under the lever knob and briskly pull the control lever back into the 45 degrees of travel. Throttle movement will begin after 45 degrees.

Once the shift has been completed, continue to move the control lever slowly in the desired direction to increase speed.

Note: When shifting from forward to reverse or reverse to forward, be sure to stop the control lever in the neutral position and allow the engine to fall between 600-800 RPM before completing the shift.

Underway

If the oil pressure gauge indicates low or no oil pressure, stop and check the oil level. If the temperature gauge indicates overheating, stop and check the raw water impeller for blockage. **DO NOT** operate the boat until the cause for the warning has been found and corrected.

CAUTION

Continued operation after the warning light has illuminated may cause severe engine damage. This will void your warranty.

Stopping

Step 1: Slowly bring the control lever to the neutral position. If the boat has been driven for a long period of time or at high speed, allow the engine a 2-3 minute cool-down period at low idle (600-800 RPM).

Step 2: Turn the ignition key to the OFF position to stop the engine.

Step 3: If any problems were encountered during operation, have the boat inspected by your MasterCraft dealer. Request any necessary repairs before operating again.



Operational Hints

MasterCraft urges you—and all others who will be operating the boat—to seek certified instruction from the local boating authorities. This section is designed to present the most basic operational principles. It is NOT intended to cover all conditions encountered during operation. Therefore, the principles presented in this manual are limited to the facts related directly to the operation of the boat, while the responsibility for the proper application of these principles belongs with you.



Adding additional ballast to your MasterCraft boat is not recommended, and can result in impaired visibility, diminished handling characteristics and instability when operating your boat, and may result in potential structural and/or engine damage to your boat, which damage will not be covered by your warranty.

Loading

Never overload your boat. The maximum weight capacity as listed on the certification plate includes all items added to the boat (persons and gear). Also, proper distribution of weight is critical to boat performance. Allocate the load as evenly as possible.

These capacities include filled ballast bags, whether they are factory-installed, dealer-installed or added by the customer.

Note that adding ballast bags reduces the number of people and the amount of gear that can be added. Failure to adhere to the total maximum capacity may result in too much strain on the drive train or can sink the boat. This is not covered under warranty!



Emergencies

Know how to use and spot distress signals—and offer assistance if possible. Remember, you may need assistance some day.

Courtesy

Always respect the rights of others on the water. Keep wide when passing, slow down in crowded areas, be alert and be aware of your wake and wash.

First Time Operation

When taking to the water for the first time, you must keep in mind a few general guidelines:

- **Practice makes perfect!** Start in calm water with no wind or current and plenty of room until you get the feel for the boat and its controls.
- **Proceed slowly!** Give yourself time to think, react and maneuver.
- **Recognize outside forces!** Check the wind direction and velocity, as well as water currents and waves.
- **Have a crew on hand!** Have friends or family ready with fenders, lines and a boat hook to assist you when docking, as well as launching and loading.
- **Remember that a boat is not an automobile!** Boats cannot be maneuvered and stopped like a car. Boats steer from the stern (rear) and have no brakes.

Basic Maneuvering

Steering response is dependent upon three factors: rudder position, motion and throttle. While high speed maneuvering is relatively easy and takes little practice, slow speed maneuvering is far more difficult and requires much time and practice to master.

With both steering and propulsion at the rear of the boat, the initiation of a turn pushes the stern of the boat away from the direction of the turn. The stern follows a larger turning circle than the bow. This is especially important to remember when making close quarters maneuvers.

While the effects of unequal propeller thrust (torque steering), wind, and current may not always be present, a practiced driver will use them to his advantage.

Unequal thrust is a phenomenon shared by all single-engine, propeller-drive boats. A counterclockwise rotation propeller tends to cause the boat to drive to port when going forward, and to starboard when going backward, with the rudder in the straight-ahead position.

At high speed, there is compensation for this effect and it is virtually non-existent. But, at slow speed—and especially during backing—the effect can be very pronounced. This is the main reason most experienced drivers approach with the dock to the starboard of the boat.

Stopping—or checking headway—is a technique that must be mastered. With no brakes, reverse must be used to stop the boat. The momentum of the boat will vary according to the load. Make it a practice to slow to no-wake speed before shifting into reverse.

When practicing maneuvering techniques, always do so in open water that is free of traffic. Adequate practice may make the difference between a pleasurable experience or a damaging—at the least, embarrassing—one.

High Speed Operation

Your MasterCraft boat was designed to be a high-performance ski boat. You may have seen professional drivers with advanced operating skills perform high-speed maneuvers and on-a-dime turns. DO NOT attempt to duplicate or simulate these feats. Paid, professional drivers log thousands of hours on the water and carefully choreograph every move. Plans are made in advance in the event the routine must be aborted. Maneuvers of this nature could cause serious injury or death, as well as damage to your MasterCraft that will not be covered under warranty.

For the best engine performance and longevity, the wide-open-throttle (WOT) engine operation must be near the top of, but within, the specified WOT operating range. To adjust the WOT operating range, you must select a propeller with the proper diameter and pitch. The propeller supplied with your boat was chosen for best all-around performance under average operating conditions.

Load, weather, altitude and boat condition all affect WOT engine operation. If you use your boat for several different applications such as wakeboarding, barefooting and cruising, it may be necessary to have two or more propellers of different size and pitch to allow the engine to operate in the WOT range for each application.

Propping the boat should be done after the engine break-in and the initial 10-hour dealer check. The boat should be loaded the way it would normally be for each application. For example, if you are propping the boat for wakeboarding, fill the ballast tanks and add the people and gear you would normally expect to carry in the boat. Take the boat out and after warm-up, run it at wide-open-throttle and note the maximum RPM. EFI engines are

equipped with RPM limiters to prevent over-revving. Take note if the RPM limiter is activated.

If the WOT RPM is higher than the maximum RPM in your engine's WOT operating range, the boat is under-propped. The engine operating ranges for engines in MasterCraft boats are:

- Predator engine:**
4400-4800 RPM
- MCX engine:**
4800-5200 RPM
- LQ9 Cadillac engine:**
4800-5400 RPM
- 8.1 Liter engine:**
4800-5400 RPM



Installing a higher-pitched propeller will reduce the WOT ROMs. **An engine that is over-revving may quickly experience catastrophic damage.**

If the WOT RPM is lower than the minimum RPM in your engine's WOT operating range, the boat is over-propped. Installing a lower-pitched propeller will increase WOT ROMs.

An engine that is under-revving is "lugging." This places a tremendous load on the pistons, crankshaft and bearings and can cause detonation, piston seizure and other engine damage.

Elevation and weather also have a very noticeable effect on the wide-open-throttle power of an engine. Since oxygen gets thinner as elevation increases, the engine begins to starve for air. Humidity, barometric pressure and temperature have a noticeable effect on the density of air since heat and humidity thin the air.

This phenomenon can become particularly apparent when an engine is propped out on a cool, dry day in spring and later, on a hot, humid day in summer, and does not have the same performance. Although some performance can be regained by dropping to a lower-pitch propeller, the basic condition still exists. The propeller is too large in diameter for the reduced power output. An experienced marine dealer can determine how much diameter to remove from a lower-pitch propeller for specific high-elevation locations.

MasterCraft's engine manufacturer suggest that consumers consult with the dealer from whom you purchased your boat on the best propeller for the application in which you expect to run your boat. **However, you should be aware that changing your propeller may void your warranty.** Again, working with your dealer is your best bet to ensure excellent performance.



Unusual Operating Conditions

If the body of water is unknown, talk to the local boaters about the type of obstacles you may encounter beneath the water's surface. Rocks, tree stumps and sandbars are all dangerous and damaging. Be especially wary of rivers and man-made lakes. Rapidly changing conditions can cause daily changes in underwater hazards.

Stay well clear of floating debris. What looks to be a small branch in the water may well turn out to be an entire tree.

When traveling through weedy areas, keep an eye on the engine temperature gauge. Weeds caught up and blocking the water flow through the raw water intake or transmission cooler will cause trouble. Also, after leaving the weedy area, shift to neutral for a few seconds and then to reverse for a few seconds to unwind any weeds that may have wrapped around the propeller.

Docking and Tie-up

Approach docks slowly, with the starboard side of the boat if possible. The natural tendency to torque steer with the rotation of the propeller at slow speeds makes docking easier on that side. Also, use wind and current to your advantage when docking.

Before tying-up the boat, be sure to use enough dock bumpers to protect the boat from damage. If possible, tie-up with the bow toward the waves. Use good quality double-braided nylon line. Tie-up only to the lifting or tie-down eyes. Never use the handrails or ski pylon.

If the boat is to be moored for a long period of time, use chafing protectors to protect the gel coat finish. Leave a little slack in the lines, allowing for some wave movement or tidal action where applicable.

If the boat is to be kept in or near water for the season, consider the purchase of a boat lift. These lifts prevent the build-up of marine growth on the hull as well as protecting it from damage typical of on-water storage, such as blistering. Make sure the boat lift supports the hull correctly. See the next section, *Lifting the Boat*.

Lifting the Boat

When the boat is hoisted from the water, use the lifting eyes or a sling for easy, damage-free lifting.

CAUTION

DO NOT use the ski pylon for lifting. It is **NOT** designed as a central lifting point. Also, **DO NOT** use the stern ski tow as a lifting ring. The deck will be damaged. See the *Storage Cradle* sub-section of the Lifting the Boat section of this Manual. Also never lift a boat with a large amount of water in the bilge or containing a water-filled device such as a Fat Sac or ballast system. The extra stress will put an excessive load on the hull and lifting equipment that may seriously damage the boat and void your warranty.

Using Lifting Eyes

An overhead hoist with two-ton capacity (minimum) should be used to lift your boat. Cables should be rated for at least 3500 pounds each. When lifting, keep the bow slightly higher than the stern to prevent any possibility of water running into the engine exhaust manifold.

Using Lifting Slings

An overhead hoist with a two-ton capacity (minimum) should be used. Slings must be 6 inches wide by 20 feet long and a minimum of 3500 pounds capacity each. Use an eight-foot spreader bar on each sling to prevent damaging side pressure to the deck or gunwale molding.

CAUTION

Lifting slings must never contact shafts, struts or hardware protruding from the hull. Damage caused by slings will void your warranty.

CAUTION

When your boat is out of the water, it is important to support the hull correctly to avoid any hull damage that will void your warranty.

Storage Cradle

If a storage cradle is used, the hull must be properly supported to prevent load damage. *This can occur with as little as 15-pounds per square inch of pressure!* **DO NOT** support the boat by resting the hull on the keel. Vertical

supports must extend from the chine to the keel with no gaps between the hull and cradle supports. A total support area of at least 250 square inches is required for proper support.

Protect all items extending from the hull from resting on the cradle or the ground. **DO NOT** apply any load stress to the prop, shaft, rudder, swim platform, water intake grate or other protruding items.



Corrosion

Galvanic Corrosion

Galvanic corrosion (electrolysis) to the boat is the decomposition of metal due to the effects of electrolytic action. When two dissimilar metals are immersed in a conductive fluid (salt water), an electric current is produced, much like the action of a battery. As the current flows, it takes with it tiny bits of the softer metal. If left unchecked, a great deal of damage could occur.

If you operate in salt, polluted or brackish waters, your boat should be equipped with a transom-mounted zinc anode to prevent damage to those metal parts coming in contact with the water. The zinc is, by design, self-sacrificing. It is slowly eroded away by electrolytic action and requires periodic inspection for deterioration.

If the zinc shows extreme erosion, it must be replaced to continue protection, or damage to other metal parts may result.



Salt Water Corrosion

Your boat has been designed for operation in fresh water. If you are operating temporarily in salt, polluted or brackish water, you will need to flush with fresh water. The entire engine cooling system should be flushed with fresh water for at least 10 minutes after each use. If you operate continuously in salt water, the closed-cooling system option is the recommended application.

Marine Growth

If accelerated marine growth is a problem in your area, an anti-fouling bottom paint may be necessary to slow growth while protecting your gel coat.

Before selecting a bottom paint, talk with other boaters and your MasterCraft dealer to determine the product that works best in your area. Many local variables can affect the selection of paint. Be sure to follow the paint manufacturer's directions exactly.



Be sure that all fasteners you use are approved and rated for marine use. Most fasteners used on MasterCraft boats are stainless steel or specially coated to resist corrosion.

Note: Damage due to corrosion is not covered under warranty!



Use of improper parts can cause component or engine failure, which may result in serious injury or death!

Cleaning

Periodic cleaning is the best way to keep your boat looking like new. Regular washing and waxing keep dirt and scum from building up and deteriorating the finish. Keeping your boat in a showroom-new condition results in personal satisfaction and higher resale value.

Your boat is made of fiberglass-reinforced plastic resin material that is easy to clean and care for. Several layers of resin material are chemically bonded together to form the hull. The smooth outside surface of the hull is a layer of gel coat resin. While the gel coat is solid color, the thickness of the layer is only a few millimeters thick—like paint on a car but much tougher, and chemically bonded.

Beneath the gel coat surface is a series of layers of chemical resin, fiberglass mat and woven roving. It is these layers that give the boat its strength and keep the hull shape. The boat bottom also uses special core-mat material for its strength-to-weight and superior marine performance.

Hull

When washing the boat, be sure to use a mild detergent and warm water solution. **DO NOT** use abrasive cleaners, solvents, ammonia or chlorine as these will damage the gel coat surface. Under extreme conditions, special cleaners may be used to remove marine growth from the hull. See your MasterCraft dealer for further instructions.

Waxing the entire gel coat surface at least twice a season is recommended for all climates. Use of a specially formulated marine gel coat wax, such as MasterCraft Premium Marine Wax, will reduce color fade, soil and scum adhesion. If the gel coat has chalked or faded from lack of proper maintenance, buffing may be necessary to bring back the shiny appearance. Hand buffing with a #7 rubbing compound or power buffing with glazing compound #1 will quickly restore the surface.

Upholstery

Regular washing with mild detergent and warm water or vinyl cleaners is sufficient to keep the cushion and vinyl coverings in good condition. Keep the cushions from becoming soaked, and dry thoroughly after washing to prevent mildew accumulations after the boat is covered. Prop up the cushions in the boat when it is covered to take advantage of air circulation. Spray with a mildew repellent.

While your vinyl is made to withstand the elements, it is important to care for it by keeping it clean at all times. Many substances may stain your vinyl if left untouched over a period of time. Remember to remove any contaminant and clean vinyl immediately.

Our vinyls are made to withstand the effects of sun, heat, acid rain and soiling, under normal conditions. Please consult the following cleaning recommendations before cleaning your upholstery.

Certain household cleaners, powdered abrasives, steel wool and industrial cleaners can

cause damage and discoloration. These are not recommended for use. Dry cleaning fluids and lacquer solvents should not be used as they will remove the printed pattern and gloss. Waxes are not recommended because many contain dyes and solvents that can permanently damage the protective coating.

In some instances, consumers have reported the appearance of a pink stain on vinyl that is resistant to various cleaning methods. Our lab tests indicate that the pink stain has been present in the past, but it



becomes more visible to the naked eye whenever the whitest-white vinyls are used. **This is true regardless of manufacturer or vendor.** MasterCraft has chosen a white that reduces the appearance of the pink stain but retains as much of the lightest white we can use.

Although there can be other causes for pink staining in vinyls, most pink stains are caused by dyes produced by micro-organisms. These dyes are metabolic products of the micro-organisms, otherwise known as a form of fungi.

It is virtually impossible for consumers to avoid these micro-organisms as they exist in the atmosphere. It is also more prevalent in high-humidity areas. Rain can cleanse the air with the result that the micro-organisms are deposited on items such as marine vinyl.

While the vinyl is treated to resist the growth of micro-organisms (*meaning the vinyl is not a food source*), the stain results from failure to properly clean and maintain the vinyl. This means that after use, the upholstery must be cleaned with a soft brush and warm soapy water, followed by a thorough rinse with clean water. If this procedure is not followed, the micro-organisms can find the marine vinyl to be a suitable host site. This situation is worsened if the boat is stored without proper ventilation or if the boat cover is put on while the vinyl is still wet, creating a situation in which all forms of fungi (*mold and mildew*) thrive.

The organism causing the pink stain has been identified by the Burlington Scientific Corporation as *Streptovorticillium reticulum*, although there are other strains of organism that can cause stains.

Failure to follow these instructions in the proper



Acceptable Upholstery Cleaners

MasterCraft Premium Shine & Protectant
Vinyl Finish Vinyl Cleaner
Dish Soap, such as Dawn or Ivory
Fantastik
303 Protectant

Unacceptable Upholstery Cleaners

409 (*it states not for use on vinyl*)

Murphy's Soap
Simple Green
DC Plus
Armorall
Top Kote Sealant
Son of a Gun
Orange 88 Degreaser
Roll Off
Bleach/Baking Soda
Turtle Wax/Tar Remover
APCO
Tannery
Harbo Master

*Any product not listed above in the
Acceptable Upholstery Cleaners!*

care of upholstery can cause your warranty to be voided!

The cleaning table on the next page is offered only as a suggestion and aid in attempting to deal with stains. We cannot guarantee that the cleaning methods will work. **Stains from any external source are unlikely to be covered by warranty.**

Carpet

Occasionally washing with mild detergent and warm water or household carpet cleaners will help keep the carpet clean. Thoroughly hose the detergent out of the carpet and into the bilge. (*This is usually the best time to clean the bilge also.*) Allow the boat to remain uncovered in the sun for several days to prevent any mildew or odor caused by moisture.

Teak Wood

Regular cleaning and oiling of teak wood will maintain its original appearance. Use a teak cleaner that can penetrate the pores of the wood and cleanse them of dirt and stains. Avoid caustic teak cleaners since they can damage the wood. Immediately after cleaning, an oil sealer should be applied with a soft cloth. Allow a couple of hours for the oil to soak into the wood and apply a second coat. Wipe off excess oil to prevent a varnish look.

Common Stains	Steps:	1	2	3
Betadine		B	A	
Chewing Gum		D	A	
Eyeshadow		E	B	
Motor Oil		B		
Spray Paint		B		
Mildew or Wet Leaves*		C	B	A
Shoe Polish*		D	B	
Yellow Mustard		A	B	C
Oil-Base Paint		D	B	
Suntan Lotion		A	B	
Tar/Asphalt		D	B	
Lipstick		A	B	
Latex Paint		A	B	
Crayon		D	B	
Ketchup		A	B	
Grease		D	B	
Ballpoint Ink*		E	B	A
Household Soil		A	B	
Permanent Marker*		E	B	C
Coffee, Tea, Chocolate		B		



DO NOT USE 409 CLEANER OR SILICONE-BASED PRODUCTS!!!

A = Medium-soft brush; warm soapy water/rinse/dry.

B = Vinyl finish cleaner.

C = One (1) tablespoon ammonia, one-fourth (1/4) cup of hydrogen peroxide, three-fourths (3/4) cup of water/rinse dry.

D = Wipe or scrape off excess (chill gum with ice).

E = Denatured alcohol/rinse/dry.

* Sun tan lotion, shoe polish, wet leaves and some other products contain dyes that stain permanently.

Windshield

Cleaning the windshield when needed is an important safety precaution. Your MasterCraft windshield is made of tempered safety glass and requires special cleaning to prevent scratches to the surface. Use a mild soap solution and damp cloth only. Harsh detergents, solvents, chemicals or dry cloths could damage the windshield. Also, when your boat is in service, avoid using the windshield as an aid for balance or getting out of a seat. This causes undue stress on the window frame and could damage it.

Stainless Steel and Chrome

Stainless steel and chrome-plated parts are not totally resistant to corrosion. Occasional cleaning and polishing with a marine chrome-and-stainless polish will maintain and extend the useful life. In salt water areas, rinse all hardware with fresh water and apply a light coating of protective oil to enhance the appearance after each use.

Sun Top and Boat Cover

Occasional cleaning of the top and cover should be done with mild soap and warm water. Thoroughly wet the entire surface and use a soft-bristled brush. Rinse completely and allow to drip dry. Then allow it to lay in the sun until completely dry. After cleaning, treat with a water repellent as necessary.

For heavy soil, a mild solution of 1/3-cup bleach, 1/4-cup household soap and one gallon of water may be used for soaking. **DO NOT** allow to soak for more than 20 minutes. Longer can cause deterioration of the stitching. Rinse completely and allow to drip dry. Then follow up with time in the sun until it is completely dry.

We strongly recommend the use of MasterCraft's GMP products, which are specially formulated for use in your boat!

Scheduled Maintenance Checks and Services

Frequency and Scheduled Maintenance

Proper care, maintenance and adjustment will contribute to the peak performance of the boat, while also extending the overall service life and the resale value.

Most MasterCraft boats built over the past decade are equipped with Indmar engines, and the information that follows was developed with their assistance. The instructions are grouped by the required service intervals. The pages that follow also provide instructions on how to accomplish the required checks, inspections and services listed. Your MasterCraft dealer or service center is the best source for proper maintenance.

The following definitions apply to maintenance:

Check: Verify the operational readiness by physical measurement, i.e., measuring the oil level with the dipstick gauge, or alignment with a feeler gauge.

Inspect: Determine the operational readiness by examination, i.e., by sight, sound or feel.

Change: Tasks required periodically to keep the boat in proper operating condition, i.e., drain, replenish or service.

New Boat Break-In

Note: MasterCraft recommends these functions be performed by factory-trained MasterCraft technicians.

- Change the engine oil and filter after the initial 10 and 50 hour mark of operation. Use only manufacturers' recommended lubricants. (See *Quarterly and Annual Maintenance* also.)
- Lubricate the engine starter drive gear and shaft. (See *Quarterly Maintenance* also.)
- Check the alignment of the propeller shaft. (See *Annual Maintenance* also.)
- Have your dealer change the fuel filter after the first 50 hours of operations, and then again at 100 hours. The fuel filter should be changed annually if less than 100 hours are run during the previous season.

Before Each Use

Before the engine has been started:

- Inspect the intake water strainer for blockage. If there is blockage, check the transmission cooler also.
- Check the cooling system level (*fresh water cooling-equipped boats only*).
- Check the alternator belt for looseness or damage.
- Inspect the battery connections and hold-downs.
- Inspect the drive train for loose or missing hardware.
- Inspect the throttle and shift cables for kinks, wear and interference with other components.
- Inspect the raw water impeller if the boat showed signs of overheating during the last operation.
- Inspect the propeller shaft log for excessive water entry.
- Inspect the fuel system lines and connections for leakage.
- Inspect the exhaust system for leaks.

As you start the engine:

- Check that the voltage registers a fully charged battery.





After the engine has run at least three minutes:

- Change the engine oil and filter.

Annually (Every 100 hours)

Note: MasterCraft recommends that these functions be performed by factory-trained MasterCraft technicians.

Before the engine has been started or after it has cooled:

- Clean the engine flame arrestor.
- Replace the fuel filter (*trained technician-only function due to pressure in-line*).
- Perform an engine tune-up.
- Replace the raw water impeller.
- Replace the ballast pump impeller.
- Check the propeller shaft coupler alignment.
- Lubricate the steering system.
- Lubricate the throttle and shift cables.
- Check the engine mounts.
- Inspect the complete fuel system for leakage.

After the engine has run at least five minutes:

- Change the engine oil and filter.
- Change the transmission fluid.

Details follow in the next few sections.



After running the engine at least five minutes:

- Check the transmission fluid level.
- Check the engine oil level.

Quarterly (Every 50 hours)

Note: MasterCraft recommends that these functions be performed by factory-trained MasterCraft technicians.

Before the engine has been started or after it has cooled:

- Lubricate the engine starter gear and shaft.
- Check the safety equipment.

Before Each Use*Check the transmission cooler for debris*

Because this process should be completed while the engine is cool and cannot cause burns to your skin, we recommend you do this before starting your boat.

Step 1: Ensure the engine is OFF and the engine safety starting switch disconnected. Be certain that the throttle/shift control lever is in neutral. Open the engine compartment. The transmission cooler is located either near the top or on the side of the engine.

Step 2: Loosen the clamp surrounding the water intake hose at the back of the transmission cooler and slide off the hose.

Step 3: Check the screen inside for signs of debris. Even small amounts of debris must be removed to prevent the material from clogging the cooler and preventing it from functioning properly. The screen is permanently in place and your boat must not be operated with any foreign materials blocking the flow of water through the cooler.

Step 4: After cleaning, re-attach the hose and clamp.

Important: This is a critical function of routine maintenance. Even clean-appearing waterways may have debris such as pine needles or moss that can enter the cooling system and create a blockage against this screen. Failure to perform this function can result in serious overheating of the engine. Damage to the engine caused by overheating is not covered by warranty! Always pay attention to your temperature gauge, even if you are carefully performing this check. Blockage of the transmission cooler or a faulty raw water impeller are too-frequent causes of overheating. Water in the transmission may void the warranty!

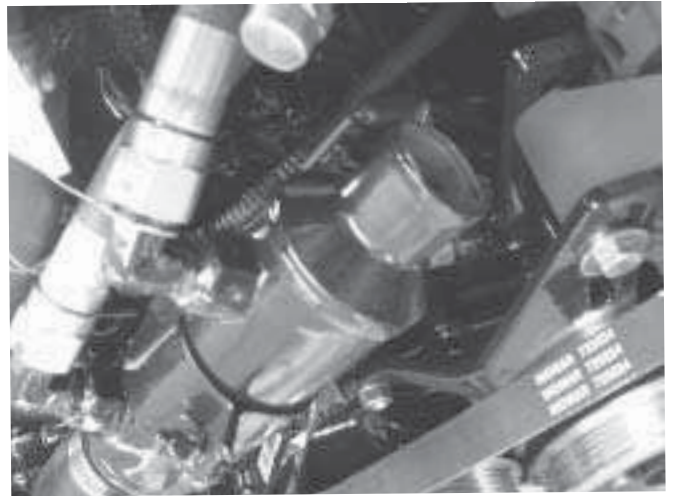
*Check the coolant level*

This procedure applies only to boats equipped with the fresh water cooling system or closed system. Because this process should be completed while the engine is cool and cannot cause burns to your skin, we recommend you do this before starting your boat.

Step 1: Ensure the engine is OFF and the engine safety switch disconnected. Be sure the throttle/shift control lever is in neutral. Open the engine compartment and locate the closed cooling system tank adjacent to the engine.

Step 2: Remove the cap and check the

level, which should be 2/3 full. If the level is below that, add coolant (**only ethylene glycol or propylene glycol**) in the appropriate mixture with distilled water. **DO NOT** overfill the tank. **DO NOT** mix anti-freeze types. See the *Storage and Winterization* section of this manual for additional details regarding coolants.

Step 3: If the tank was completely empty, see your MasterCraft dealer for assistance immediately as your engine cooling system needs purging. This function should be completed only by a trained MasterCraft service technician.

CAUTION

Failure to maintain your coolant at the proper level can cause engine damage. Your warranty will not cover engine damage due to overheating or any other cause associated with improper coolant levels.

Check the alternator belt for looseness or damage

Because this process should be completed while the engine is cool and cannot cause burns to your skin, we recommend you do this before starting your boat.

Step 1: Ensure the engine is OFF and the engine safety switch disconnected. Be certain that the throttle/shift control lever is in neutral. Open the engine compartment and locate the alternator belt.

Step 2: Check the alternator belt tension at the top, midway between the circulating pump pulley and the alternator pulley. The belt should be tight enough so that it will deflect no more than one-quarter to one-half inch when pressed with the thumb or finger.

Note: *If the belt is too tight, excessive belt and bearing wear can occur. If the belt is too loose, slippage can occur, resulting in low alternator output and rapid belt wear.*

Step 3: If your engine is not equipped with a belt tensioner, loosen the alternator mounting hardware and tighten the hardware. Recheck the belt tension. On engines with serpentine belt systems, however, no change is necessary. Belt tension is maintained by the automatic belt tensioner.

Step 4: Check the underside of the belt that actually runs in contact with the pulleys. Look for signs of excessive wear, cuts or weakness across or in the grooves. If there are any, replace the belt. We recommend contacting your MasterCraft dealer for service assistance.

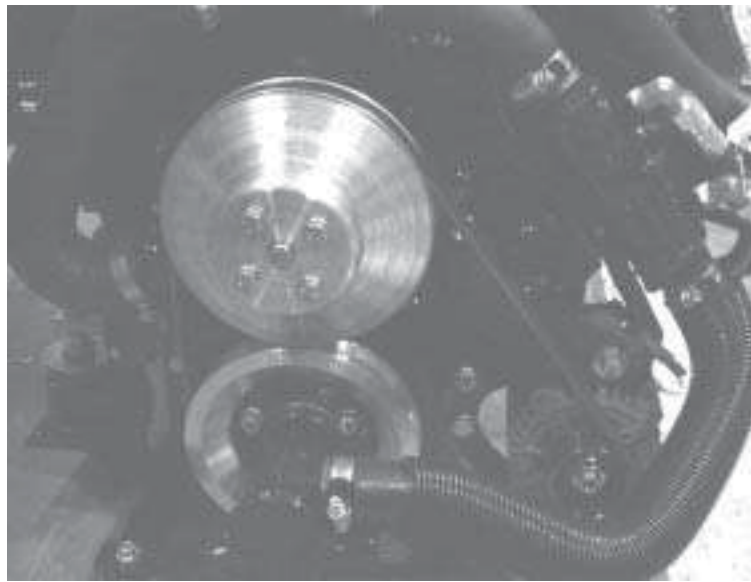

Inspect the battery connections and hold-downs

Because poor connections or hold-downs can result in erroneous voltmeter readings, we recommend you do this before starting your boat.

Step 1: Ensure the engine is OFF and the engine safety switch disconnected. Be certain that the throttle/shift control lever is in neutral. Locate the battery. Batteries are placed in a variety of locations, depending on the model. Check under the observer seat or behind the rear seat.

Step 2: Check that the battery post connections are clean and tight. If not:

- Loosen and remove the negative terminal connection first. Be careful not to touch the positive terminal with the wrench.
- Loosen and remove the positive terminal connection.
- Remove the battery hold-downs and remove the battery from the boat.
- Clean corrosion from the battery posts with a battery terminal cleaner. Clean the battery with a water-and-baking-soda solution. Use care to avoid allowing the solution to enter the battery vents. Rinse the battery with fresh water.

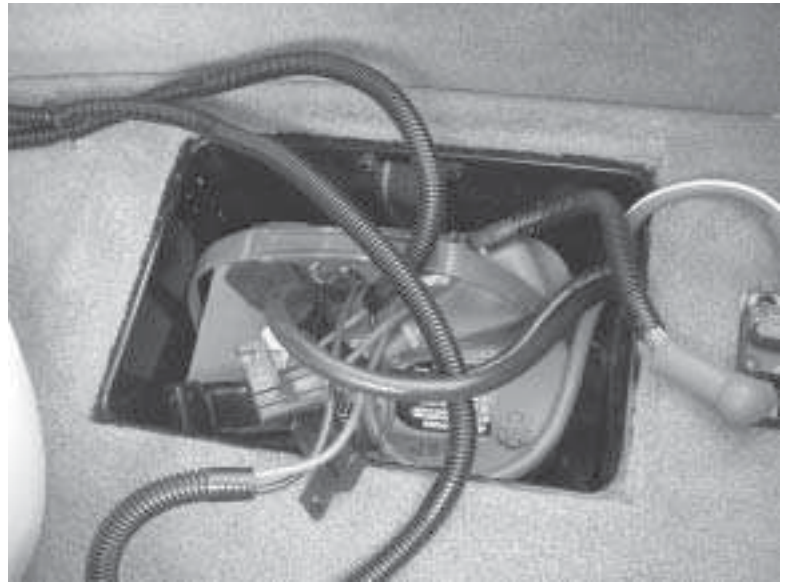
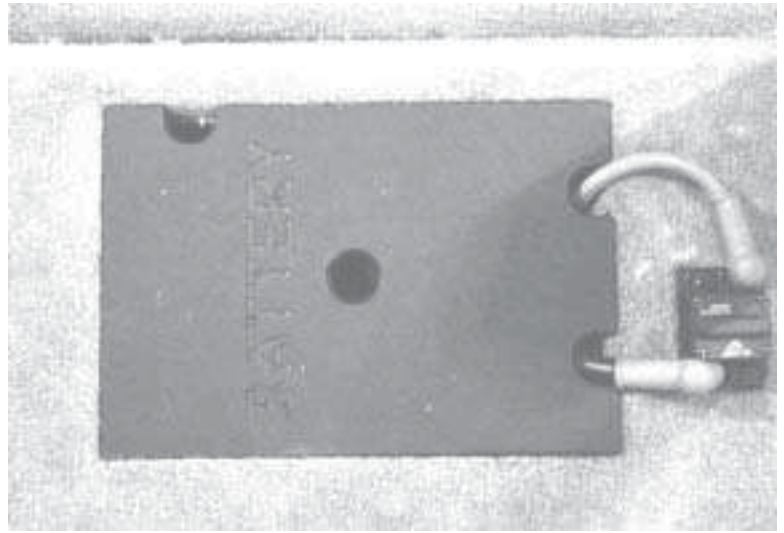

WARNING

Battery electrolyte fluid is dangerous. It contains sulfuric acid, which is poisonous, corrosive and caustic. If electrolyte is spilled or placed on any part of the human body, immediately flush the area with large amounts of clean water and seek medical aid.

- Use a battery terminal cleaning brush to remove corrosion from the inside of the battery terminals. Clean the terminals with a water-and-baking-soda solution and rinse.
- Reconnect the positive terminal first, then the negative. Tighten the terminals. Coat both terminals completely with a thin covering of marine grease. Be sure that the rubber boot covers the positive terminal completely.

Note: Your engine is designed to work with the standard electronics installed in your boat. If you add other electrical components or accessories, you could change the way the fuel injection controls your engine or the overall electrical system functions. Before adding electrical equipment, consult your dealer. If you don't, your engine may not perform properly.

CAUTION

Add-on equipment may adversely affect the alternator output or overload the electrical system. Any damage caused as a result will not be covered by, and may void, your warranty.



WARNING

When charging, batteries generate small amounts of dangerous hydrogen gas. This gas is highly explosive. Keep all sparks, flames and smoking well away from the area. Failure to follow instructions when charging a battery can cause an electrical charge or even an explosion of the battery which could cause serious injury or death

If you ever need a replacement battery, be certain to select a marine battery with at least 750 cold-cranking amps at zero degrees Fahrenheit. Before disconnecting the battery, make sure the ignition key and all accessories are in the OFF position. Also remember to re-attach the cables correctly, with the negative cable connected to the negative or (-) post and the positive cable connected to the positive or (+) post.

MasterCraft recommends the use of a spiral cell type battery, such as the Optima brand. These batteries exceed most other batteries in holding and extending a charge.

Inspect the engine for loose or missing hardware

Because this process should be completed while the engine is cool and cannot cause burns to your skin, we recommend you do this before starting your boat.

Step 1: Ensure the engine is OFF and the engine safety starting switch disconnected. Be certain that the throttle/shift control lever is in neutral. Open the engine compartment and visually inspect the engine.

Step 2: Systematically check the entire engine for loose and missing hardware. Try to shake components by hand such as the alternator and the motor mounts. If a looseness problem exists, see your MasterCraft dealer.

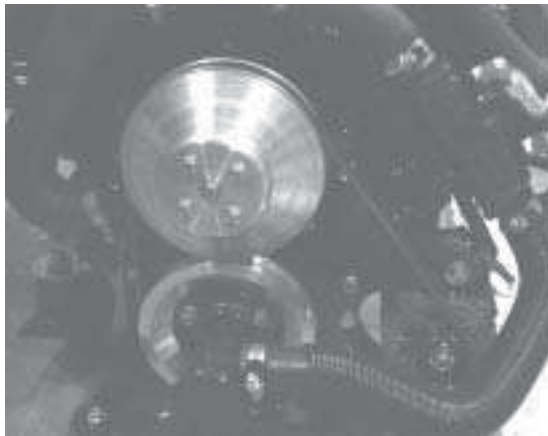

Inspect the throttle and shift cables for kinks, wear and interference

Because this process should be completed while the engine is cool and cannot cause burns to your skin, we recommend you do this before starting your boat.

Step 1: Ensure the engine is OFF and the engine safety starting switch disconnected. Be certain that the throttle/shift control lever is in neutral.

Step 2: Open the engine compartment and locate the throttle and shift cables. Follow each cable back under the floorboards and feel for any kinks and wear on the outer jacket. Any sign of cable damage is cause for replacement. See your MasterCraft dealer.

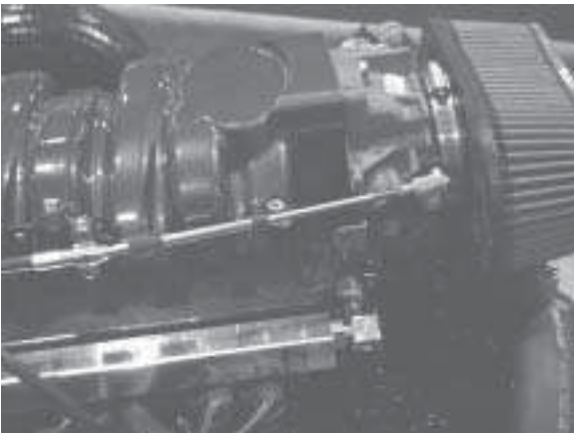

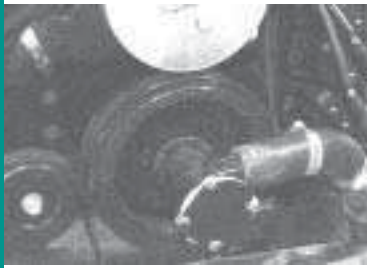

Before Each Use

(if the engine has shown evidence of overheating during the previous outing. If overheating occurs during an outing, checking the impeller is imperative!)

Check the impeller

Because this process should be completed while the engine is cool and cannot cause burns to your skin, we recommend you do this before starting your boat. If checking during an outing, allow the engine to cool some before checking and be very careful to avoid burns from contact with hot engine parts.

Step 1: Ensure the engine is OFF and the engine safety starting switch disconnected. Be certain that the throttle/shift control lever is in neutral. Open the engine compartment and locate the raw water impeller housing.

Step 2: Disconnect the intake and outflow hoses on the raw water impeller housing to check for debris. Reconnect.

Step 3: Remove the screws on the impeller cover and very carefully break the gasket seal. Because a good seal is very important to avoid potentially serious leaks while the engine is in operation, it is advisable to have some new gaskets in the boat's glovebox for such occasions. If even a slight gap exists, you may experience problems in the future, so replacing the gasket is a better idea than taking any chances with an old one. Also, leaving any portion of the old gasket on the housing or cover can impede good contact.

CAUTION

Ignoring elevated temperatures on a temperature gauge or any other evidence of the engine operating at temperatures above recommended levels can result in serious damage to the engine. Any resulting damage will not be covered by, and may void, your warranty!

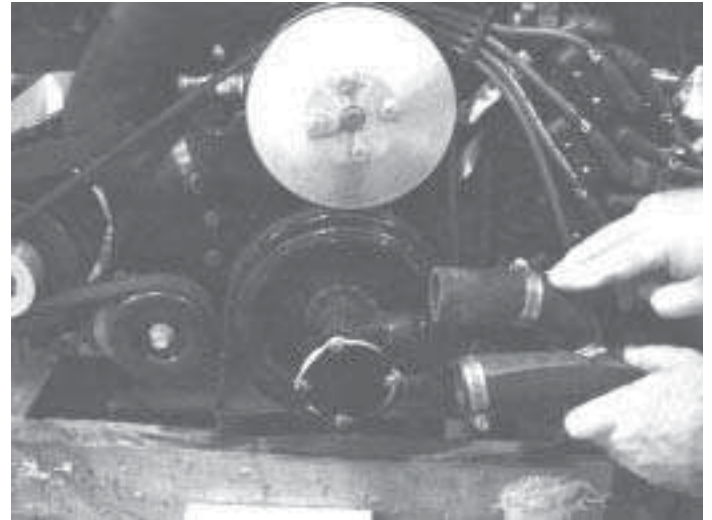

Step 4: Inspect the inside of the impeller housing. The paddle-wheel should appear as it does in this photograph. If any rubber extrusions on the end of the arm appear frayed or worn, it should be replaced. If there is not a slight bend to the paddle-wheel arms, replace it. Debris entering the impeller inevitably will damage it; but it serves its purpose in keeping debris out of much more expensive internal engine parts.

Step 5: If you are uncertain about the condition of the impeller, remove it and inspect. When installing or re-installing one, you will find it is a tight fit. This ensures proper operation. The use of soap or Vaseline will help with installation. You will note that proper placement on the gear results in a squeeze on the arms. This is the correct installation.

Step 6: Place a gasket between the housing and the cover after ensuring that the surfaces are smooth and clean; then re-install the screws in place. Do not over-tighten the brass screws. This can cause them to break.



*Inspect the propeller shaft log
for excessive water entry*



This inspection requires the operation of the engine with the engine compartment open; thereby creating a potentially dangerous situation. Therefore, this inspection should be performed by your authorized MasterCraft dealer. **Whenever this inspection is performed, utmost care must be exercised to avoid personal injury or death.** This inspection must be performed with the boat in the water. Your MasterCraft dealer will perform the following steps in conducting the inspection:

FOR THE PROSTAR 190, 197,
209, X-7 AND X-9 MODELS:

Step 1: Ensure the engine is OFF and the engine safety starting switch disconnected. Be certain that the throttle/shift control lever is in neutral.

Step 2: Begin with the boat in the water. Open the engine box and check for leakage while the engine is OFF. No leakage is permissible while the engine is OFF. If any is apparent, refer to the *Check Propeller Shaft Coupling Alignment* section in the **Annual** maintenance section.

 **WARNING**

The engine box serves as a machinery guard. The engine must be OFF whenever the box is open. Clothing or body parts can get caught in moving parts, causing serious injury or death. Keep away from moving parts!

Step 3: This portion of the inspection requires the operation of the engine with the engine compartment open and should be performed by your MasterCraft dealer. Your dealer will start the engine with the engine compartment open to inspect the shaft log for leakage. Ten-to-fifteen drops of water per minute is normal. If the water entry is excessive, however, then the packing gland must be adjusted. To adjust:

- Turn the engine OFF.
- Loosen the packing gland nut.
- Hand-tighten the packing gland nut and re-tighten the lock nut.
- Operate the boat again and check for the proper adjustment. If the water leakage continues, the shaft log may need to be re-packed. Check the alignment also. Contact your MasterCraft dealer for assistance as needed.

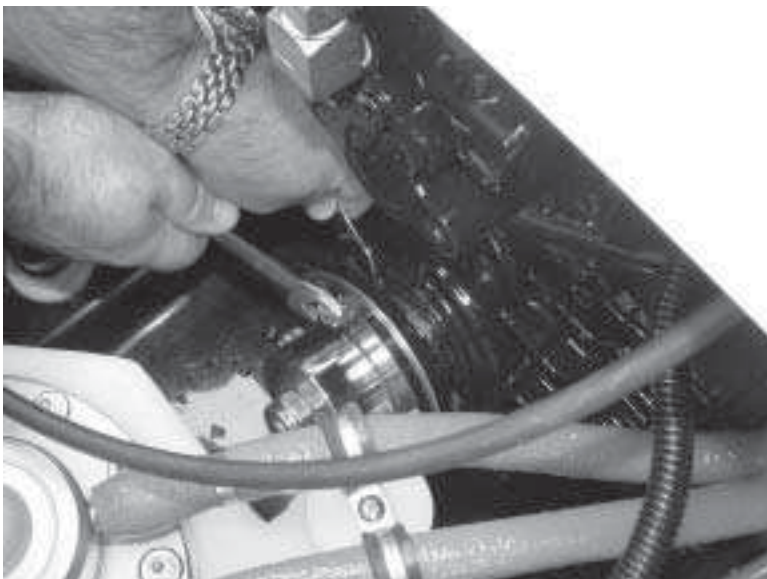

FOR THE PROSTAR 205, X-2
AND ALL MARISTAR MODELS:

Step 1: Ensure the engine is OFF and the engine safety starting switch disconnected. Be certain that the throttle/shift control lever is in neutral.

Step 2: Begin with the boat in the water. Open the engine box and check for leakage while the engine is OFF. No leakage is permissible while the engine is OFF. If any is apparent, refer to the *Check Propeller Shaft Coupling Alignment* section in the **Annual** maintenance section.



WARNING

The engine box serves as a machinery guard. The engine must be OFF whenever the box is open. Clothing or body parts can get caught in moving parts, causing serious injury or death. Keep away from moving parts!

Step 3: This portion of the inspection requires the operation of the engine with the engine compartment open and should be performed by your MasterCraft dealer. Your dealer will start the engine with the engine compartment open and should ensure that the water hoses are connected and that the engine plugs are installed in order to properly inspect the shaft log for leakage. DO NOT run the engine if there is no water supply as this will burn out the seal. With another person operating the boat, inspect the shaft log for leakage. Ten-to-fifteen drops of water per minute is normal. If the water entry is excessive, however, then the packing gland must be adjusted.

CAUTION

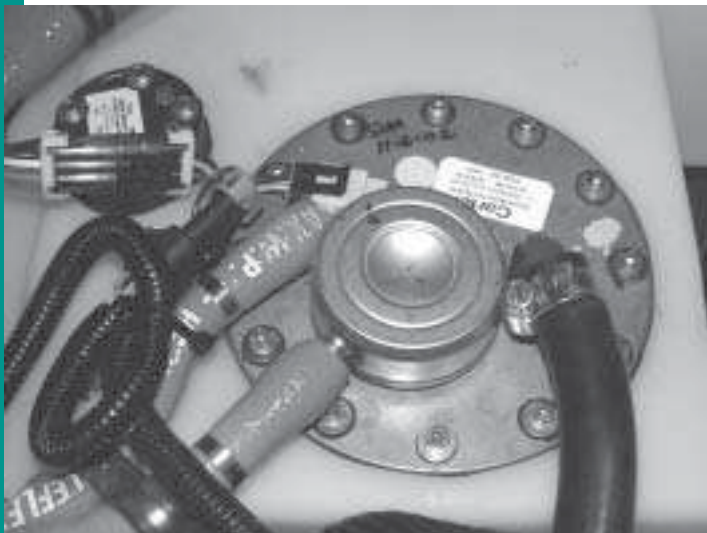
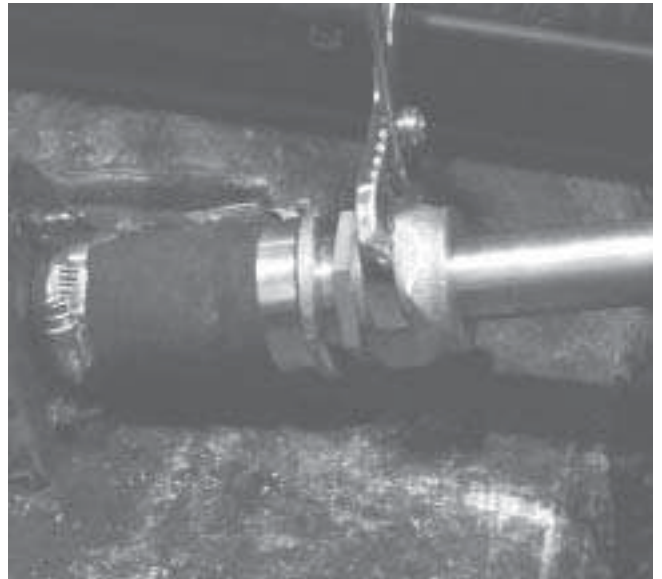
Attention must be paid to any leakage occurring in the propeller shaft log area. Water intrusion into the transmission, which can happen if excessive leakage is occurring, can cause serious damage and void your warranty.

Inspect the fuel system for leaks

This inspection requires the operation of the engine with the engine compartment open, thereby creating a potentially dangerous situation. Therefore, this inspection should be performed by your authorized MasterCraft dealer. **Whenever this inspection is performed, utmost care must be exercised to avoid personal injury or death.** Your MasterCraft dealer will perform the following steps in conducting this inspection:

Step 1: Ensure the engine is OFF and the engine safety starting switch disconnected. Be certain that the throttle/shift control lever is in neutral. The engine must be cool.

DANGER

Gasoline is highly flammable and its vapors may ignite resulting in fire or explosion. Be sure to keep all sparks and flames well away from the area while inspecting the boat's fuel system.

Step 2: Open the engine compartment and visually check as much of the fuel system from the tank to the engine as you can see.



The engine box serves as a machinery guard. The engine must be OFF whenever the box is open. Clothing or body parts can get caught in moving parts, causing serious injury or death. Keep away from moving parts!

Step 3: This inspection requires the operation of the engine with the engine compartment open and should be performed by your MasterCraft dealer. Your dealer will start the engine with the engine compartment open and look for signs of leakage. Because the fuel system is under pressure, any leaks should be quickly noticeable. If any leaks are observed the engine must be immediately shut down. The leak must be repaired before the engine is restarted. See your MasterCraft dealer for parts and service. Because the lines on late model MasterCraft boats are pressurized, they can be disconnected and/or removed ONLY by using specialized tools that are not available to the public.

This is important! Fuel leakage can lead to a build-up of potentially explosive fumes within the engine compartment. DO NOT IGNORE NOR OVERLOOK THIS INSPECTION AND REPAIR AS NECESSARY!

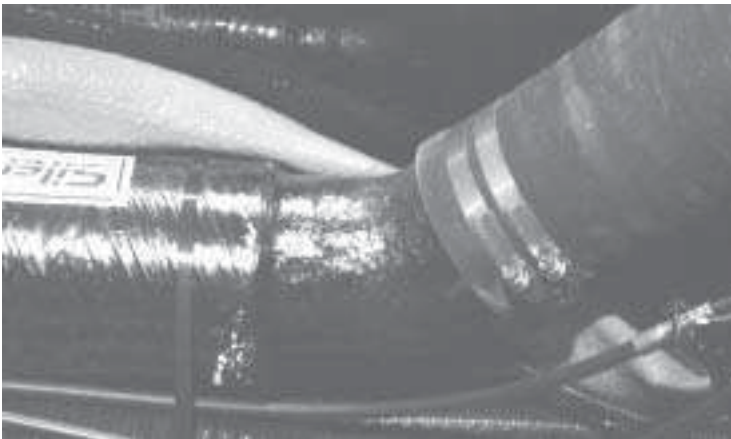

Inspect the exhaust system for leaks

This inspection requires the operation of the engine with the engine compartment open, thereby creating a potentially dangerous situation. Therefore, this inspection should be performed by your authorized MasterCraft dealer. **Whenever this inspection is performed, utmost care must be exercised to avoid personal injury or death.** Your MasterCraft dealer will perform the following steps in conducting the inspection:

Step 1: Ensure that the engine is OFF and that the engine safety starting switch is disconnected. Be certain that the throttle/shift control lever is in neutral. The engine must be cool.



The engine box serves as a machinery guard. The engine must be OFF whenever the box is open. Clothing or body parts can get caught in moving parts, causing serious injury or death. Keep away from moving parts!

Step 2: Open the engine compartment and visually check the exhaust system from the engine to the transom for any obvious damage to exhaust lines or the muffler.

Step 3: This inspection requires the operation of the engine with the engine compartment open and should be performed by your MasterCraft dealer. Your dealer will start the engine with the engine compartment open.

Step 4: The dealer will carefully inspect the hose connections between the exhaust manifolds and the mufflers for leakage.

Step 5: If leakage is apparent, tighten the hose clamps, being careful not to crimp the hose. If the leakage is significant or is occurring at a location other than the joints (such as a split in a hose), see your MasterCraft dealer for parts and service. **This is important!** Exhaust fumes can cause illness or impairment, including carbon monoxide poisoning. Equally important to consider, leakage can lead to a build-up of potentially explosive fumes within the engine compartment. **DO NOT IGNORE NOR OVERLOOK THIS INSPECTION! REPAIR AS NECESSARY!**

Check that the battery is fully charged

As you start your boat, check all gauges, but pay particular attention to the voltmeter.

While starting the engine, check that the voltmeter reads between 12.4 and 14.5. An erratic reading can be a sign of low voltage. The voltmeter is your best indication of the state of your battery. It is not fool-proof, however. While the reading will indicate that the battery is producing current, if in a previous operation you had reason to suspect a problem with your battery, check with your MasterCraft dealer.

The 2004 models are equipped with a low-voltage battery alarm. In the event that the stereo has been functioning when the boat is not ON and running, the voltage drain on the battery can result in difficulties re-starting the boat. To avoid this situation, when the voltage level reaches a set level of 11.5 volts, the system will shut off the stereo system and sound the alarm for a period of two minutes to give boaters ample time to adjust.

If you have a dead battery, charge it with a battery charger before attempting to start the engine. Jump-starting from another boat or battery is dangerous. Charging a dead battery with the alternator on your engine will put undue stress on the alternator, which may cause it to fail.



When charging, batteries generate small amounts of dangerous hydrogen gas. This gas is highly explosive. Keep all sparks, flames and smoking well away from the area. Failure to follow instructions when charging a battery can cause an electrical charge or even an explosion of the battery which could cause serious injury or death.

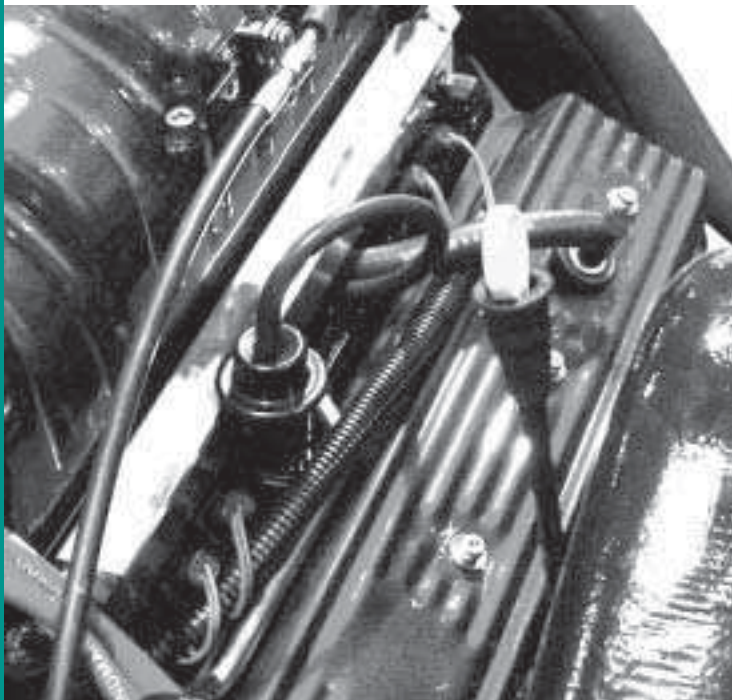

Check the engine oil level

Because you will get an accurate reading only after the engine has run long enough to thoroughly warm up (to at least 140 degrees F), this should be one of the last checks you conduct before boating. Run the engine in the water. If you are checking the transmission fluid at the same time, run the engine at least five minutes in the water (to warm the transmission fluid), and check the fluid immediately after shutting down to get an accurate reading for that. As long as you will be checking the oil fairly quickly (within two minutes of shutting off), there is no need to re-start and run the engine again.

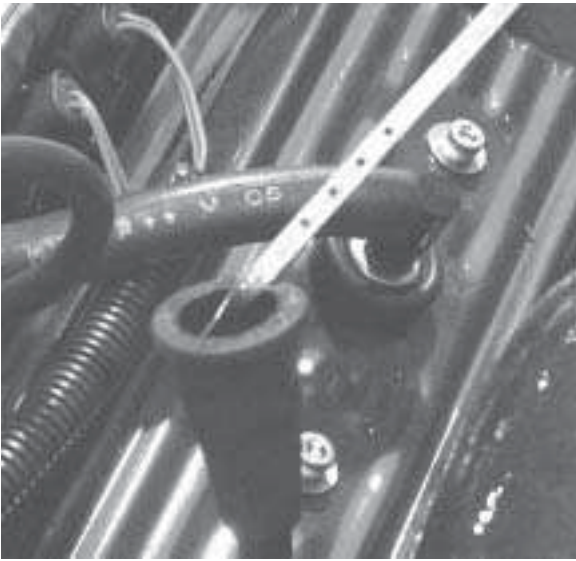

Step 1: After operating the engine at idle while in the water for at least three minutes or until warm, turn the engine OFF and disconnect the engine safety starting switch. Open the engine compartment. The engine oil dipstick is located on one side of the engine.

Step 2: Allow two minutes before checking. Then remove the dipstick and wipe it off. Insert it fully and immediately remove. Check that the oil level is between the ADD and the SAFE marks on the dipstick.

Step 3: Add oil, if necessary, through the valve cover and only enough to bring to the SAFE mark on the dipstick. **Overfill may result in damage to the engine that is not covered by warranty.** Use SAE 15W40, API SJ/CH4 oil. 20W40 oil may be substituted but only if it meets the API SJ/CH4 standards. Below 20 degrees Fahrenheit, use SAE 10W30 SJ/CD type oil if the engine will be running. **DO NOT USE OIL ADDITIVES AT ANY TIME.**

Check the transmission fluid level

Because you will get an accurate reading only after the engine has run long enough to thoroughly warm up, this should be one of the last checks you conduct before boating. Run the engine in the water at least five minutes in the water, and check the fluid immediately after shutting down to get an accurate reading.

Step 1: After operating the engine at idle while in the water for at least five minutes or until warm, turn the engine OFF and disconnect the engine safety starting switch. Be sure the throttle/shift control lever is in neutral. Open the engine compartment and locate the transmission dipstick.

Note: The transmission fluid level must be checked immediately after the engine shut-down to prevent an incorrect reading. Fluid drains back into the transmission from the cooler and cooler lines, and the dipstick could give a false reading if not done quickly.

Step 2: Remove the dipstick and wipe it off with a clean rag. Quickly reinsert it fully and immediately remove. Check that the level is at the FULL WARM mark on the stick.

Step 3: Add or remove fluid as necessary to maintain the level at the mark. **It is as important to avoid overfilling the transmission fluid as it is to avoid underfilling.** Use only the recommended automotive-type transmission fluid. Check with your MasterCraft dealer for the specifications. Never mix different types or brands of fluid! **The manufacturer specifies Dexron-III fluid in the direct drive 1:1 transmission and 15W40 motor oil in the V-drives and gear-reduction transmissions.**



Quarterly (Every 50 hours)

MasterCraft recommends that your quarterly—or 50-hour—maintenance requirements be performed by your MasterCraft dealer. The staff there has the proper equipment and technical training to best meet your service needs.

Lubricate the engine starter gear and shaft

Because this process should be completed while the engine is cool and cannot cause burns to your skin, we recommend you do this before starting your boat.

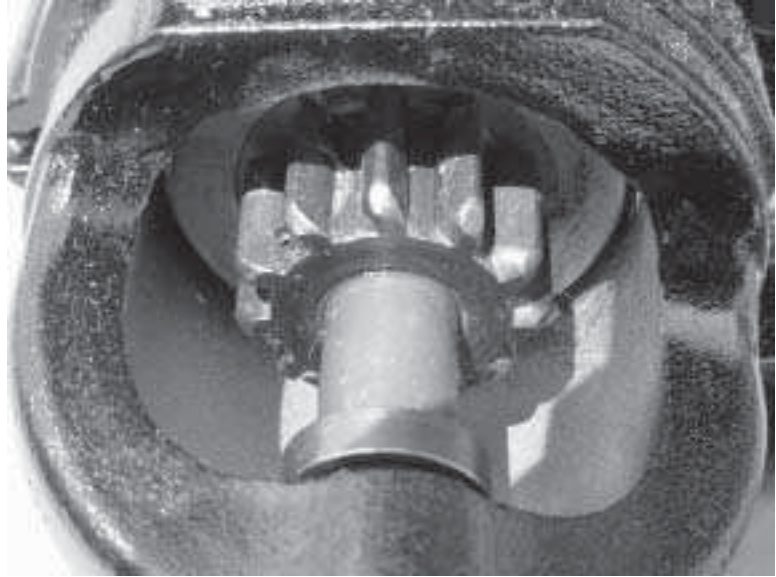

Step 1: Ensure the engine is OFF and the engine safety starting switch is disconnected. Be certain that the throttle/shift control lever is in neutral. The engine must be cool.

Step 2: Disconnect the positive (+) battery terminal.

Step 3: Open the engine cover and locate the starter on the lower starboard side of the engine.

Step 4: Disconnect the starter and carefully remove it.

Step 5: Lubricate the starter bendix with a light coating of waterproof grease or white lithium grease.

Step 6: Return the starter to the engine and reconnect. After closing the engine compartment, reconnect the positive (+) battery terminal.

MasterCraft recommends that your quarterly—or 50-hour—maintenance requirements be performed by your MasterCraft dealer. The staff there has the proper equipment and technical training to best meet your service needs.

Change the engine oil

In order to thoroughly drain all the old oil, you will need to run the boat engine long enough to reach at least 140 degrees F (approximately three minutes in most applications), before changing the oil. Do not run your engine without it being in water, unless you have the appropriate, professional hook-up available to protect the engine and drive-train components. If this is not available to you, have your MasterCraft service technician perform this service.

Step 1: Ensure the engine is OFF and the engine safety starting switch disconnected. Be certain that

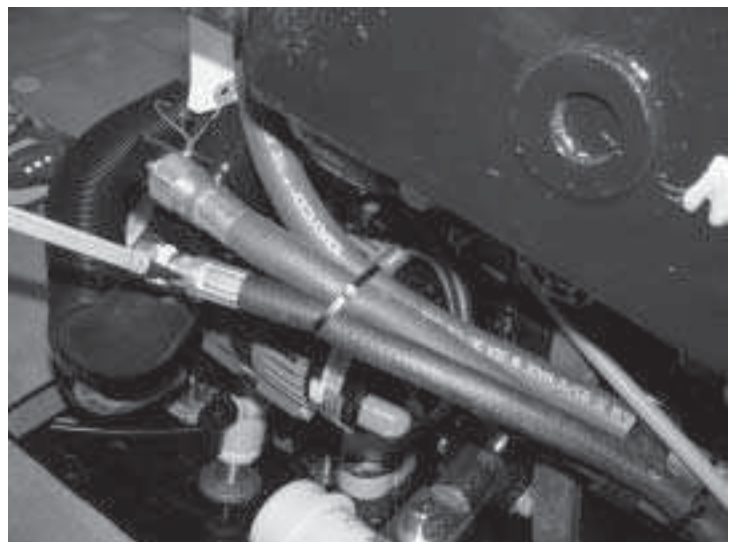

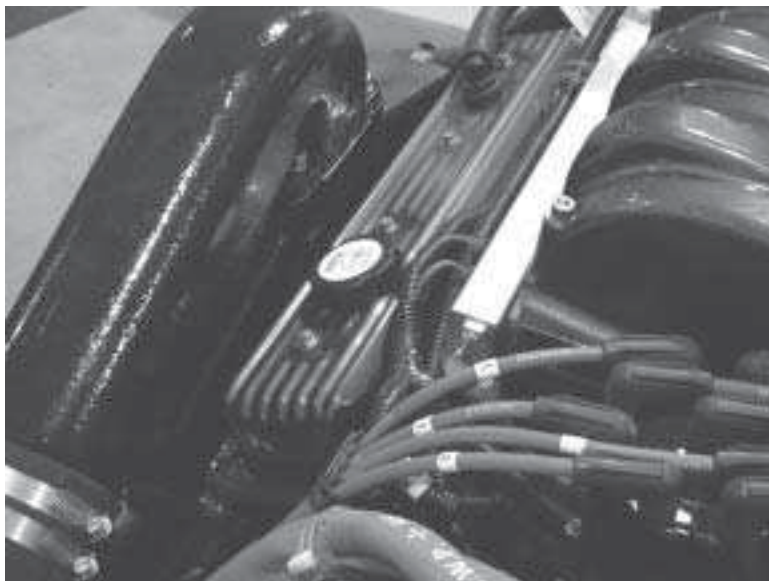

the throttle/shift control lever is in neutral. The engine must be warm.

Step 2: Open the engine compartment and locate the oil drain hose, which runs from the bottom of the oil pan along the port side of the engine. At the end of the oil drain hose is a brass plug.

Note: *Never drain oil into the bilge or into the water. Wipe up any spilled oil immediately, and dispose of the rags and drained oil in a proper manner on-shore.*

Step 3: Remove the engine oil cap located on the valve cover. This will speed-up the oil draining process.



Step 4: Remove the bilge drain plug to drop the drain hose through the hole. Drain the oil into a container on the ground. (On some v-drive models, you will thread the line through a hole that runs through the lower edge of the transom.)

Step 5: Loosen the brass end cap to allow the oil to drain; be careful to avoid rounding off the edges of the brass end cap.

Step 6: The oil filter should be changed each time the oil is changed. Remove the oil filter and dispose of it properly on-shore.

Step 7: Fill a new MasterCraft oil filter about half full with clean engine oil. Lightly lubricate the oil filter gasket and spin the filter on until the gasket makes contact. Hand tighten the filter one-quarter to one-half turn after contact. **DO NOT** use a filter wrench to tighten.



Step 8: Re-attach the oil drain plug to the end of the hose and refill the crankcase through the oil cap opening on the valve cover. Check the oil level with the dipstick. If this is the initial quarterly oil change, re-attach a cable tie around the oil drain hose and the water line on the port side of the engine as it came from the factory, to keep the line from coming in contact with any hot areas.

Step 9: The first time that you re-start the engine when it is back in the water, check the area around the filter for any leaks.

Step 10: Stop the engine and re-check the oil level. Add more oil if necessary.

Note: *The engine oil recommendation for all engines is SAE 15W40 oil, rated at SJ/CH4. This rating requires oils to have higher additives levels than typical gasoline engine oils to compensate for potential thinning or fuel dilution. Any other rating other than SJ/CH4 may result in damage or excessive wear to the engine and should be avoided!*

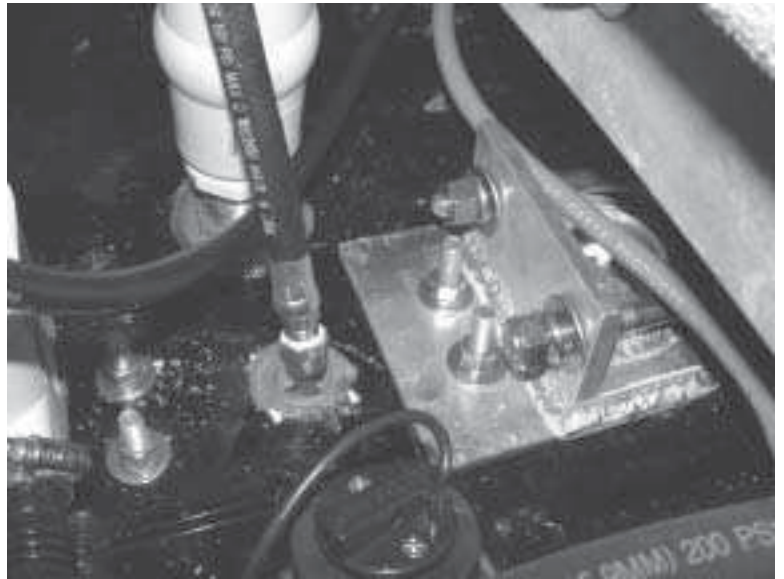

CAUTION

Failure to follow the engine oil recommendation listed in the manual can cause additional engine wear and increase the possibility of engine component failure. Damage to your engine due to incorrect oil usage can be costly to repair, and is not covered by your warranty!

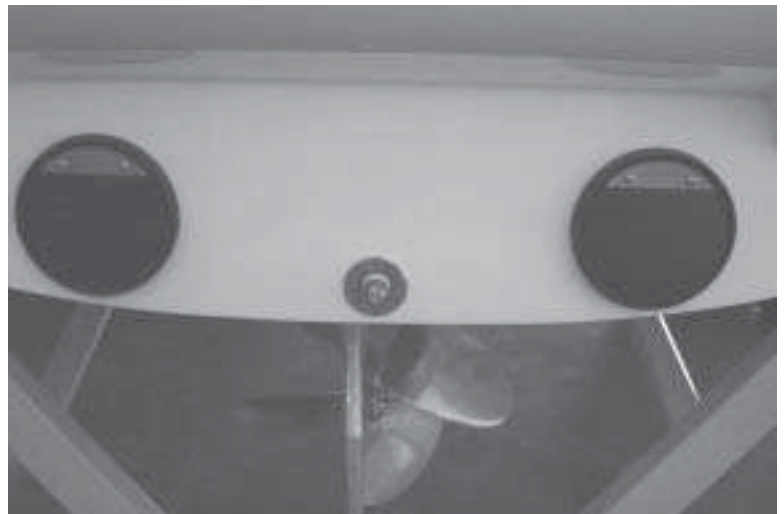

Annually (Every 100 hours)

Annual Maintenance

Some boat owners choose to execute some maintenance procedures on their boats. We have provided information on several procedures. For safety reasons, a few must be performed by MasterCraft service technicians only, such as anything involving checks and repairs on the fuel line, which is under pressure.

Regardless of whether you choose to do some of the maintenance work yourself or have it completed by a technician, these matters must be addressed on a regular basis, at 100 hours or annually, whichever comes first.

These procedures are in addition to seasonal preparation and winterization (see *Winterization* section for additional details). All of these issues are extremely important to your continued boating pleasure, as well as long life for your boat and the critical matter of safety.

Even if you plan to have annual maintenance work completed by your MasterCraft service technician, you still should review this section and ensure that you have some understanding of what is necessary to keep your boat in top condition.

MasterCraft recommends that your annual—or 100 hour—maintenance requirements be performed by your MasterCraft dealer. The staff there has the proper equipment and technical training to best meet your service needs.

Clean the engine flame arrestor

MasterCraft recommends that you have the flame arrestor inspected and cleaned by your dealer immediately prior to starting the boating season. This procedure is extremely important and should be performed at least once a year.

There may be instances in which you need to check this yourself. If you have had evidence of material collecting inside the flame arrestor in the past, you should check yours more often than annually, particularly after the boat has been sitting for an extended period of time. The flame arrestor serves as a trap for airborne materials that might otherwise enter the engine and cause damage. However, if your boat sits for a while, small creatures may crawl inside and build a nest.

Be very careful while removing and while the flame arrestor is off the engine that absolutely nothing foreign enters the engine through the area normally covered by the flame arrestor. Any materials entering can cause damage to your engine and will void your warranty.

Because this process should be completed while the engine is cool and cannot burn your skin, we recommend you do this before starting your boat.

On TBI (Predator) Engines:

Step 1: Ensure the engine is OFF and the engine safety starting switch disconnected. Be certain that the throttle/shift control lever is in neutral. The engine must be cool.

Step 2: Carefully remove the flame arrestor. On some engines it is located directly on top of the engine and slides off. On others it is located on the side. For these, you will need a screwdriver.

Step 3: Disconnect the PVC line.

Step 4: Inspect the inside of the flame arrestor for evidence of any foreign materials and gently clean out any accumulated dust, dirt or foreign materials.

Step 5: Re-install the flame arrestor.



For MCX, LQ-9 and 8.1L Engines:

Step 1: Ensure the engine is OFF and the engine safety starting switch disconnected. Be certain that the throttle/shift control lever is in neutral. The engine must be cool.

Step 2: Carefully remove the flame arrestor from the back of the engine using a screw driver on the clamp screw.

Step 3: Tap the element to dislodge any large embedded dirt and then gently brush with a soft bristle brush.

Note: Do not use gasoline, steam, caustic cleaning solution, strong detergent, high-pressure car wash or parts cleaning solvents. Any of these can harm the cotton filter media, as well as shrink and harden the rubber end caps.

Step 4: Either spray on K&N air filter cleaner or allow the air filter to soak in a pan filled with air filter cleaner. Allow the cleaner to work for approximately 10 minutes.

Step 5: Rinse off the filter with low-pressure water. Tap water is okay. Always flush from the clean side to the dirty side. This removes the dirt and does not drive it into the filter.

Step 6: Always dry naturally. After rinsing, shake off all excess water and let the element dry naturally.

Note: Do not use compressed air, open flame nor heat dryers. Excess heat will shrink the cotton filter media. Compressed air will blow holes in the element.

Step 7: After cleaning the air filter, always re-oil before using. Spray K&N air filter oil down into each pleat with one pass per pleat. Wait 10 minutes and re-oil any white spots still showing. Or use the oil from a squeeze bottle, down into the bottom and along each pleat with just one pass in each pleat. Let the oil wick into the cotton for 20 minutes. Re-oil any white spots still showing.

Note: Never use the K&N air filter without oil. The filter will not stop the dirt without the oil. Red dye is added to K&N air filter oil to assist in determining whether you have complete coverage after application. Never use automatic transmission fluid, motor oil, diesel fuel, WD-40, LPS or other lightweight oils for this purpose.

Step 8: Re-install. Make sure the element seats properly before tightening the clamp screw.

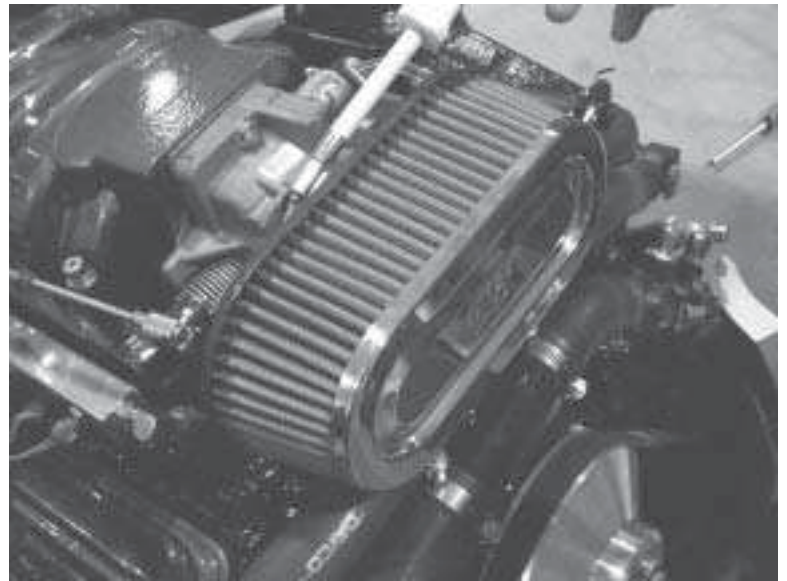

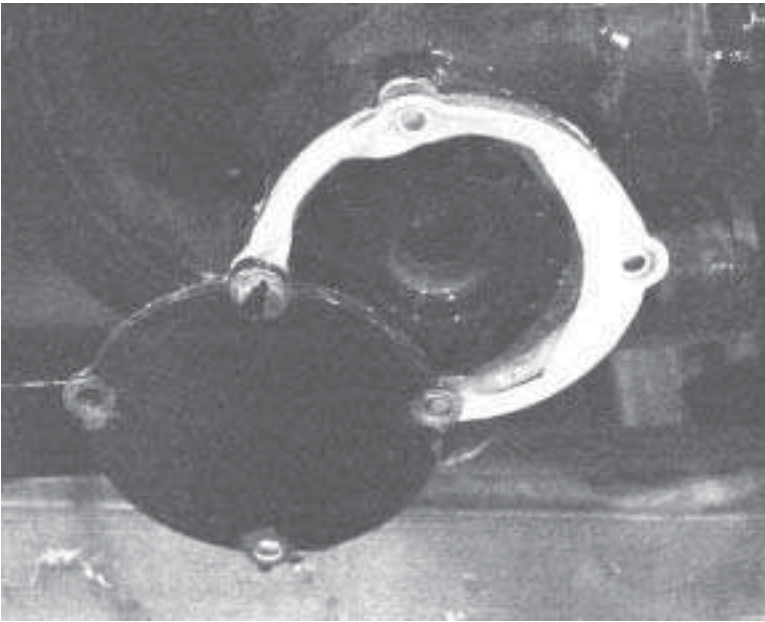

MasterCraft recommends that your annual—or 100 hour—maintenance requirements be performed by your MasterCraft dealer. The staff there has the proper equipment and technical training to best meet your service needs.

Replace the raw water pump impeller

Change the raw water pump impeller annually. This is extremely important! Through normal wear and tear, the impeller usually lasts no more than one season even under ideal conditions. If it does not function properly—and it will not when worn—it can cause serious engine overheating and potentially void your warranty!

MasterCraft recommends that this procedure be performed by a MasterCraft service technician. If, however, you wish to complete this function yourself, detailed instructions are included under *Before Each Use, Check the Impeller* section of this manual, where documentation was provided to assist boat owners who experience overheating problems or who boat in “dirty” water.

Have an engine tune-up performed

A complete engine tune-up, including replacement of the PVC valve, spark plugs, distributor cap, rotor and ignition wires (*if needed*) should be performed annually. Also, some engines require adjustments for spark, dwell and idle. All of these functions require special knowledge, tools and test equipment. For this reason, MasterCraft strongly recommends having the engine tune-up performed by your dealer.

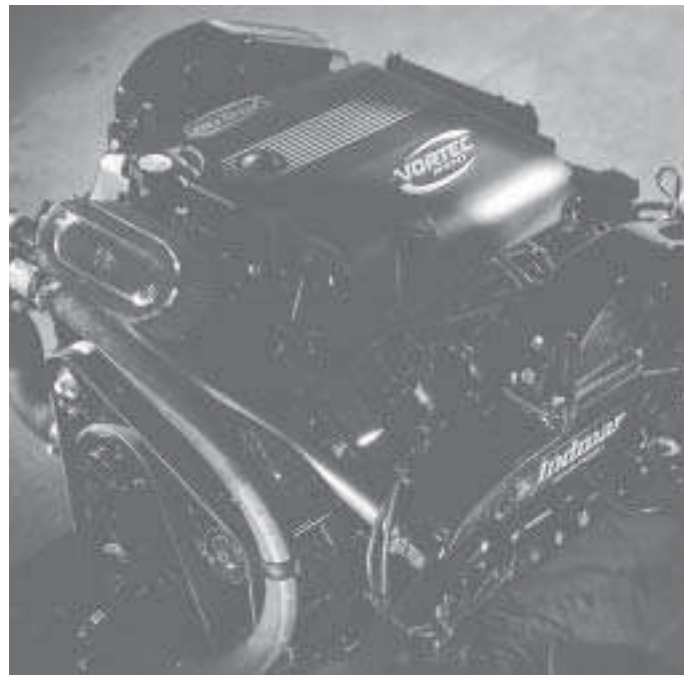

Change transmission fluid

In order to thoroughly drain all the old transmission fluid, you will need to run the boat engine for a period of at least five minutes. Do not run your engine without it being in water, unless you have the appropriate, professional hook-up available to protect the engine and drive-train components. If this is not available to you and if you do not wish to run your boat in the water and then remove it for this procedure, have your MasterCraft service technician perform this function because he has the proper equipment to protect your engine while it runs out-of-water.

Step 1: Ensure the engine is OFF and the engine safety starting switch is disconnected. Be certain that the throttle/shift control lever is in neutral. *The transmission fluid must be warmed up.*

Step 2: Open the engine compartment and locate the transmission.

Step 3: Remove the transmission dipstick.

Step 4: Use a suction pump through the transmission dipstick opening to remove the fluid from the transmission casing.

Step 5: On a 1:1 transmission, the filter is located beneath the transmission housing.

On a Power Slot transmission, the filter is accessed through a round plug on the side of the transmission housing.

On a V-drive transmission the filter is accessed through a round plug on the side of the transmission housing.

Step 6: On a 1:1 transmission, remove and clean the screen. When re-installing, use and ensure that the gasket is placed correctly, after replacing the filter.

Step 7: The following chart shows what type of fluid is needed for your change. *(If your transmission is not listed here, check with your MasterCraft dealer for specifications on capacities and recommended fluid type.)*

Transmission	Model	Ratio	Capacity	Fluid Type
ZF Hurth in-line	450D	1:1	1.7 qt. (1.6L)	Dexron II, III or MECON
ZF Hurth in-line	450A	1.5:1	2.12 qt (2L)	15W40 motor oil
ZF Hurth in-line	630A	1.5:1	4.2 qt (4L)	15W40 motor oil
ZF Hurth V-drive	G30V		4.2 qt (4L)	15W40 motor oil

Note: Access to the transmission fluid filters is somewhat difficult in some models; nonetheless, this maintenance is vital to long-term, trouble-free boating. If you feel that you cannot complete this process, contact your dealer.

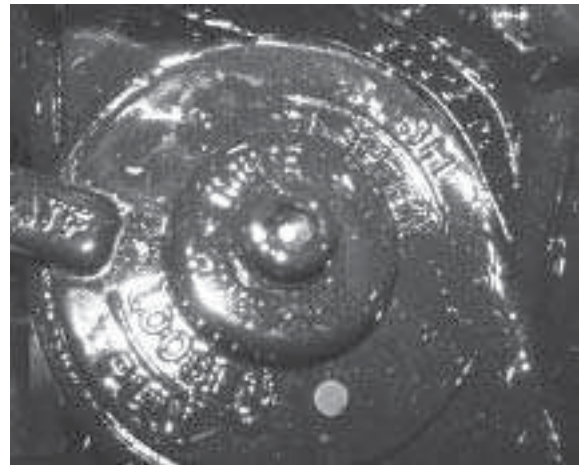
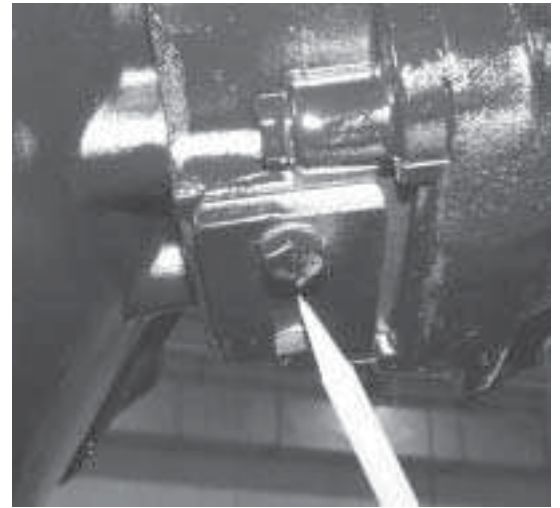

Check the engine mounts

Step 1: Ensure the engine is OFF and disconnect the engine safety starting switch. Be sure that the throttle/shift control lever is in neutral. The engine must be cool.

Step 2: Open the engine box and locate the four motor mounts.

Step 3: Check the tightness of the mounting hardware and adjustment lock-nuts. Tighten any loose hardware securely.

Check the propeller shaft coupling alignment

Step 1: Ensure the engine is OFF and disconnect the engine safety starting switch. Be sure that the throttle/shift control lever is in neutral. The engine must be cool.

Step 2: Open the engine box and locate the propeller shaft coupling.

Step 3: Remove the coupling bolts and slide the coupling apart only slightly so that the pilot flange on the propeller shaft side is still seated in the pilot bore of the transmission side.

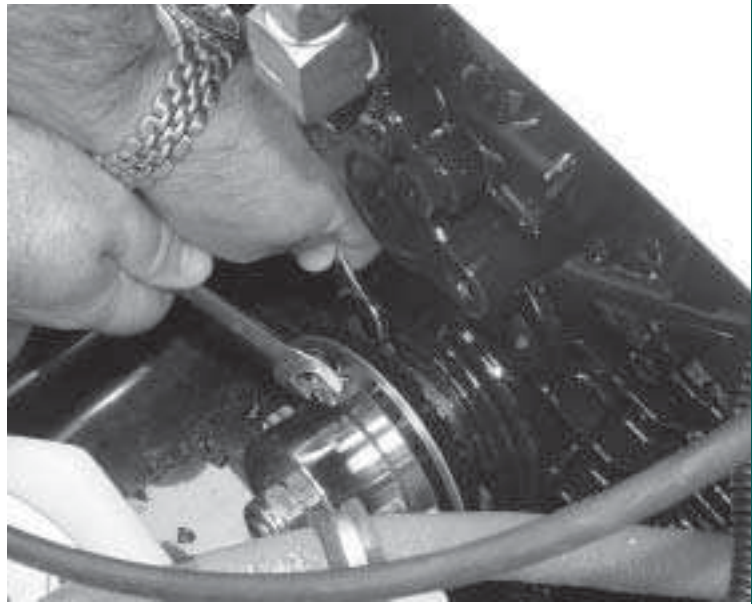

Step 4: Using a feeler gauge, measure the gap between the coupling halves at four places. Rotate the coupling flanges together one complete revolution, stopping every 90° to check clearance with the feeler gauge.

Step 5: Alignment is satisfactory when the flanges are parallel within 0.003 inch.

Step 6: If the alignment is not satisfactory, an adjustment must be made. Special tools and procedures are required for proper adjustment and should be made only by a trained technician. See your MasterCraft dealer.

Step 7: If alignment is satisfactory, re-install the flange bolts and tighten securely.

Step 8: Water test to ensure that there is no vibration. If a vibration is noticeable, see your MasterCraft dealer immediately.

Inspect the exhaust flaps for damage

Step 1: Ensure the engine is OFF and disconnect the engine safety starting switch. Be sure that the throttle/shift control lever is in neutral.

Step 2: Inspect the exhaust flap hinge for signs of deterioration. Replace the flap if necessary.

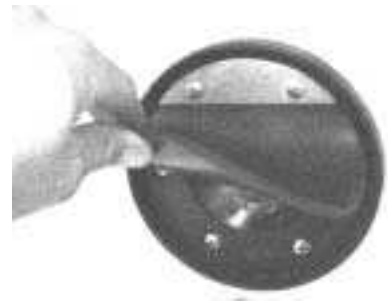

Lubricate the steering system

Because this process should be completed while all moving components of the drive train are NOT in motion, we recommend you do this while the boat is out of the water.

Step 1: Ensure the engine is OFF and disconnect the engine safety starting switch. Be sure that the throttle/shift control lever is in neutral. The engine must be cool.

Step 2: Remove the access panel in the rear trunk compartment.

Step 3: Turn the steering wheel so that the maximum amount of steering cable is seen.



Step 4: Use solvent to clean old lubricant from the cable end, pivot and rudder shaft.

Step 5: Spread a generous amount of white lithium grease over the cable end. Work the steering wheel back and forth and re-apply grease if necessary.

Step 6: Using the flexible end on a grease gun, give two full shots of white lithium grease to the two grease fittings: one on the rudder shaft, and one on the pivot. Clean up any old grease purged from the areas.

Step 7: Rotate the steering wheel back and forth several times to work the lubricant in.

Step 8: Re-install the access panel.

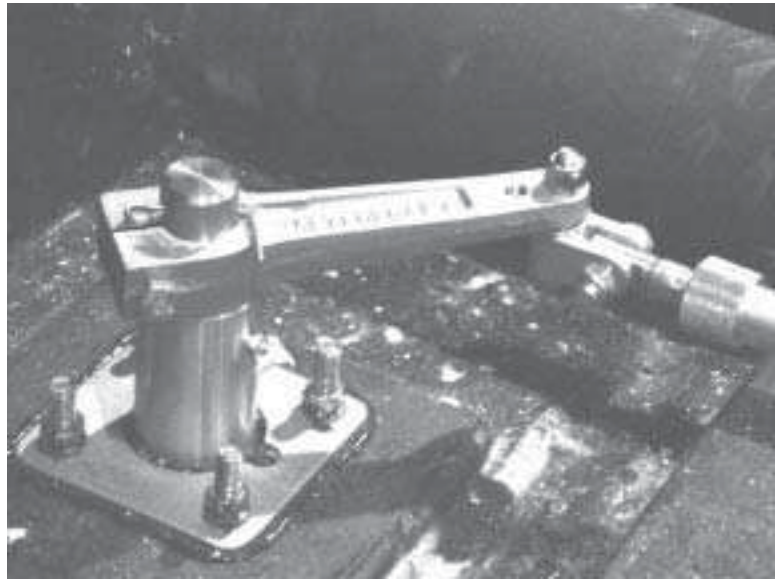

Lubricate the shift and throttle system

Because this process should be completed while all moving components of the drive train are not in motion, we recommend you do this while the boat is out of the water.

Step 1: Ensure the engine is OFF and disconnect the engine safety starting switch. Be sure that the throttle/shift control lever is in neutral. The engine must be cool.

Step 2: Open the engine box and locate the shift and throttle cable ends.

Step 3: Shift to full-throttle-forward.

Step 4: Lubricate the cable ends and connections with a coating of waterproof marine multi-purpose grease.

Step 5: Lubricate the pivots and linkages with a light grease.

Step 6: Shift the control lever from full-throttle-forward to full-throttle-reverse several times to work the lubricant in.

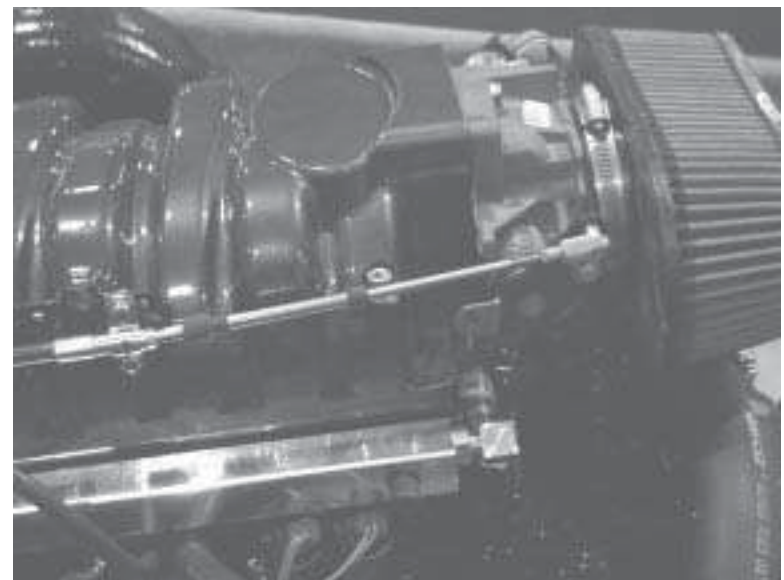
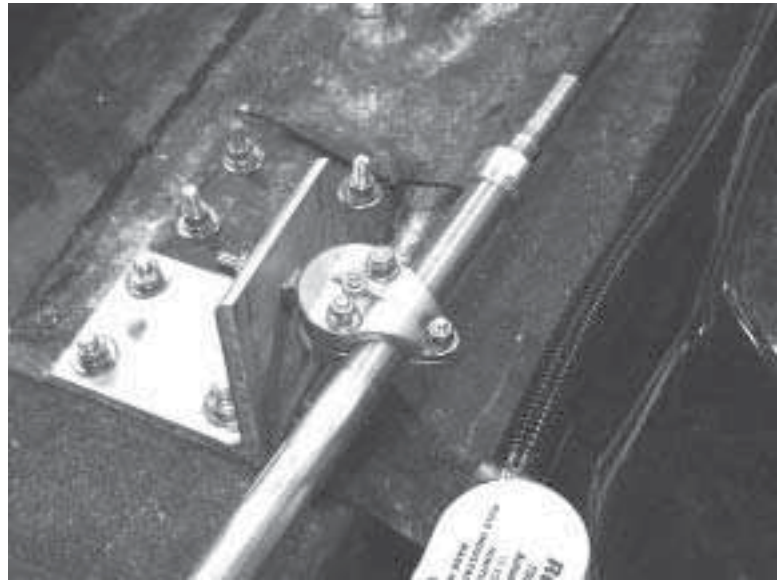



Check the ballast pump impeller

This applies only to boats equipped with some type of ballast system. The number of ballast pumps varies from system to system. You may need guidance from your dealer to locate any and all pumps.

Step 1: Remove two of the cover screws and retain the screws for the reinstallation process. Swing the cover out of the way to allow access to the impeller location.

Step 2: Using the needle-nose pliers, pull the old impeller out of the casing.

Step 3: Install the new impeller. (It is intentionally larger than the case. While gently squeezing it in, ensure that the paddle wheels angle in the same direction—counterclockwise—all the way around.)

Step 4: Slide the plate back into place. No silicone is necessary. Due to the built-in gasket, tightening the screws should prevent leakage.



Inspect complete fuel system for leakage

Although your boat engine is similar to your automobile engine, the engine compartment differs substantially. The underside of your automobile engine compartment is totally open to the atmosphere. This allows complete air circulation and ventilation. Your boat engine is housed in a closed compartment, the underside of which is the bottom of the boat.

The enclosed engine compartment limits the ventilation of gasoline and oil fumes. Because confined gasoline vapors mixed with a little air can form an explosive atmosphere, it is important to be especially vigilant in performing the following two operations:

Step 1: Run your bilge blower for at least four minutes to ventilate the bilge area each time before starting the engine.

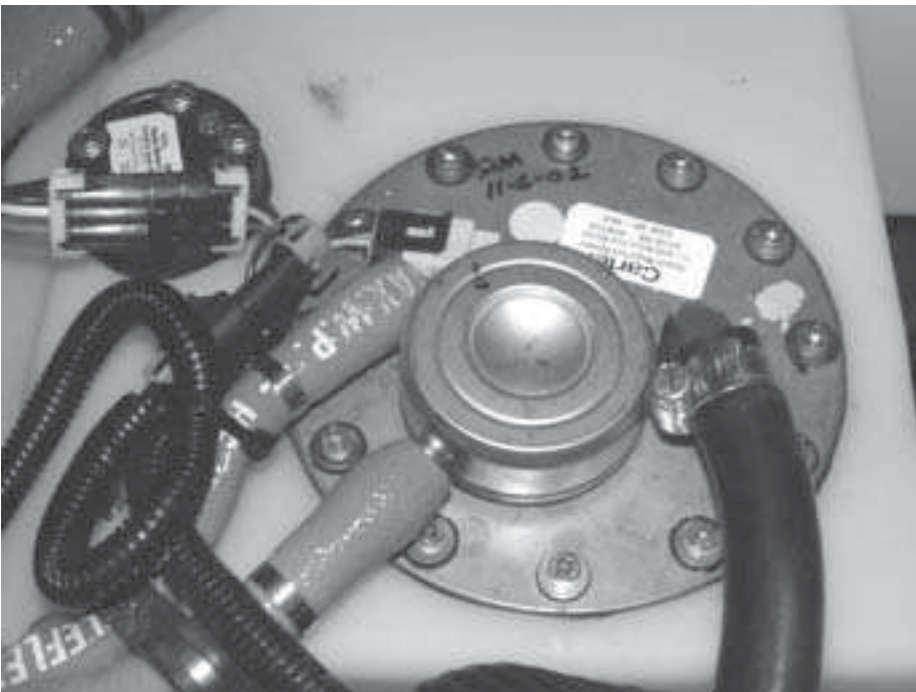

Step 2: Inspect your boat bilge area under the engine for the evidence of oil and gasoline—or any gasoline odor. This inspection should take place the first time the boat is started each day. Raise the engine cover and visually look at the bilge area under the engine.



Gasoline is explosive. If you see or smell the presence of gasoline during your inspection, **DO NOT START YOUR ENGINE!** Remove your ignition key from the ignition switch and call your MasterCraft dealer for service.

Note: If you notice loose fuel fittings, deteriorated lines or other problems associated with the fuel system, call your MasterCraft dealer. Fuel system service on later-model MasterCraft boats require special service tools and special training. Due to the potential for serious consequences when errors occur in servicing the fuel system, MasterCraft strongly encourages all boat owners to seek professional assistance from your MasterCraft service department whenever any service or perceived problems occur within the fuel system.



All replaced fuel system components must meet United States Coast Guard ("USCG") and American Boat & Yacht Council, Inc. ("ABYC") standards, and must be Underwriter's Laboratory ("UL")-approved. Inferior quality components pose a serious safety threat to you and others, and the use of inferior components may result in serious injury or death. Resulting damage may void your warranty.



The following information is applicable only to boats sold in California.

Emission Control Warranty Information

The inboard engine in your boat includes the Indmar Emission Control System identified as MFI or TBI or EM. Refer to the identification sticker on your engine to determine which emission control system was used on your engine. The fuel and ignition systems on your engine meet the stringent requirements set forth by the California Air Resources Board (CARB). Indmar also uses Sierra brand anti-freeze in the closed cooling system of your engine to reduce the environmental impact in the event that anti-freeze is expelled from the engine.

Your Indmar-manufactured engine has a special environmental label required by the California Air Resources Board (CARB). The label has 1, 2, 3 or 4 stars. A hangtag, provided with your inboard engine, describes the meaning of the star system.

The Star Label means Cleaner Marine Engines

This engine has been certified as:

The Symbol for Cleaner Marine Engines:

- Cleaner Air and Water
 - For a healthier lifestyle and environment.
- Better Fuel Economy
 - Burns up to 30-40 percent less gas and oil than conventional carbureted two-stroke engines, saving money and resources.
- Longer Emission Warranty
 - Protects consumer for worry-free operation.

Operating Fuels and Lubricants

In order to keep your engine operating efficiently and to maintain the Emission Control System the following requirements must be observed.

Fuel – Your engine was designed and certified to operate on the unleaded fuels listed below. Fuel ratings must be based on the (R+M)/2 method and meet the specifications ASTM D4814 in the US. These fuels need no additives for proper operation.

MasterCraft LQ9 engine 93 Octane

All other MasterCraft Engines 89 Octane

Lubricant – Indmar uses and recommends Pennzoil 15W40 Marine Oil for use in all of its engines. If Pennzoil 15W40 Marine Oil is not available, any 15W40 motor oil meeting the API ratings of CF/SJ, CG-4, CH-4 is acceptable. See Operator’s Manual for information regarding the use of synthetic oil.

Additives – The only additive that is recommended by Indmar for use in your engine is Sta-Bil® brand fuel stabilizer. This additive helps preserve the fuel in your tank and in the engine’s fuel system. We recommend the use of Sta-Bil® during off-season storage and for the boater that consumes less than a full tank of fuel every two weeks. See the Fuel section of your Operator’s Manual.

Emissions

Components Warranty

The following components are considered as part of the emissions control system and are covered under the *Emissions Control Warranty*.

1. Fuel Metering System

- A. Fuel injectors
- B. Fuel pressure regulator
- C. Manifold Absolute Pressure Sensor
- D. Throttle Position Sensor
- E. Idle Air Control Valve
- F. Throttle Body – Port Fuel Injection Models
- G. Throttle Body Assembly – Throttle Body Fuel Injection Models
- H. Coolant Temperature Sensor
- I. Intake Valves

2. Air Induction System

- A. Intake Manifold
- B. Air Filter (Flame Arrestor)

3. Ignition System

- A. Spark Plugs
- B. Electronic Ignition System
- C. Ignition coil and/or control module
- D. Ignition Wires

4. Lubrication System

- A. Oil pump and internal parts

5. Positive Crankcase Ventilation (PCV) System

- A. PCV valve
- B. Oil Filler Cap

6. Exhaust System

- A. Exhaust manifold(s)
- B. Exhaust riser(s)
- C. Exhaust valves

7. Miscellaneous Items Used on Above Systems

- A. Hoses, clamps, fittings, tubing, sealing gaskets or devices and mounting hardware
- B. Electronic Controls
- C. Electronic Control Module
- D. Pulleys, belts and idlers

NOTE: *The repair or replacement of any warranted part otherwise eligible for warranty coverage under the Emission Control Warranty may be excluded from such warranty coverage if Indmar demonstrates that the engine has been abused, neglected, or improperly maintained and that such abuse neglect or improper maintenance was the direct cause of the need for repair or replacement of the part.*

The emission warranty covers damage to other engine components that is caused by the failure of a warranted part.

The Indmar Operator's Manual provided contains written instructions for the proper maintenance and use of your inboard engine. All emission warranty parts are warranted by Indmar for the entire warranty period of the engine, unless the part is scheduled for replacement as required maintenance in the Operator's Manual.



One Star-Low emission

The one-star label identifies engines that meet the Air Resources Board's Personal Watercraft and Outboard marine engine 2001 exhaust emission standards. Engines meeting these standards have 75% lower emissions than conventional carbureted two-stroke engines. These engines are equivalent to the U.S. EPA's 2006 standards for marine engines.



Two Stars-Very Low emission

The two-star label identifies engines that meet the Air Resources Board's Personal Watercraft and Outboard marine engine 2004 exhaust emission standards. Engines meeting these standards have 20% lower emissions than One Star-Low Emission engines.



Three Stars-Ultra Low emission

The three star label identifies engines that meet the Air Resources Board's Personal Watercraft and Outboard marine engine 2008 exhaust emission standards or the Sterndrive and Inboard marine engine 2003-2008 exhaust emission standards. Engines meeting these standards have 65% lower emissions than One Star-Low Emission Engines.



Four Stars-Super Ultra Low emission

The four-star label identifies engines that meet the Air Resources Board's Sterndrive and Inboard marine engine 2009 exhaust emission standards. Personal Watercraft and Outboard marine engines may also comply with these standards. Engines meeting these standards have 90% lower emissions than One Star-Low Emission Engines.

Cleaner Watercraft - Get the Facts
1-800-END-SMOG • www.arb.ca.gov

Emission warranty parts that are scheduled for replacement, as required maintenance, are warranted by Indmar for the period of time before the first scheduled replacement date for that part. Emission warranted parts that are scheduled for regular inspection, but not regular replacement, are warranted by Indmar for the entire warranty period of the inboard engine.

Any emission warranty part repaired or replaced under the terms of this warranty statement is warranted by Indmar for the remainder of the warranty period of the original part. All parts replaced under this limited warranty become the property of Indmar.

If the ownership of a product is transferred during Emission Components Warranty period, this warranty shall also be transferred and be valid for the remaining coverage period provided that Indmar is notified in the following way:

- a. The former owner contacts Indmar and provides us with the required information listed below; or
 - b. Indmar receives proof that the former owner agreed to the transfer of ownership and we are provided with the information listed below.
- **Current owner's name, address, telephone, engine serial number and date of purchase**
 - **New owner's name, address, telephone, engine serial number and date of transfer**

Send the above information to:

Indmar Products
5400 Old Millington Rd
Millington, TN 38053
Attn: Emission Warranty Transfer

NOTE: The above procedure is valid for the transfer of the Emission Components warranty only. Refer to the Limited Warranty Section in this manual for information regarding warranty transfer of the remaining engine components.

Emission Maintenance Requirements

The following procedures are required to maintain the Emission Control System of your engine:

- **Engine oil and filter:** Change oil and filter after the first 10 hours then every 50 hours or annually, whichever occurs first.
- **Spark Plugs:** Replace every 300 hours or annually, whichever occurs first.
- **PCV Valve:** Replace every 300 hours or annually, whichever occurs first.
- **Flame Arrestor:** Clean every 100 hours. Replace as necessary.
- **Spark Plug Wires:** Inspect annually. Replace as necessary.

Emission Component Part Numbers

Following are the Indmar Part numbers for the Emission Maintenance Components (**parts can be ordered only through an authorized MasterCraft dealer; parts cannot be ordered directly from the factory**):

MasterCraft TBI

Engine Oil:	81871001	Oil Filter:	81501001
Spark Plugs:	81556034AC MR34LTS or 556199 AC (49-132)		
PCV Valve:	81506002	Flame Arrestor:	81525009
Plug Wires:	81756002	Distributor Cap:	81556083
		Distributor Rotor:	81556084

(Parts must be ordered through an authorized MasterCraft dealer.)

MasterCraft MCX

Engine Oil:	81871001	Oil Filter:	81501001
Spark Plugs:	81556034AC MR34LTS or 556199 AC (49-132)		
PCV Valve:	81506001	Flame Arrestor:	81525011
Plug Wires:	81756002	Distributor Cap:	81556083
		Distributor Rotor:	81556084

(Parts must be ordered through an authorized MasterCraft dealer.)

MasterCraft LQ9

Engine Oil:	81871001	Oil Filter:	81501001
Spark Plugs:	81556188 (AC 41-952)		
PCV Valve:	81551364	Flame Arrestor:	81525021
Plug Wires:	81751202	Distributor Cap:	N/A
		Distributor Rotor:	N/A

(Parts must be ordered through an authorized MasterCraft dealer.)

MasterCraft 8.1L

Engine Oil:	81871001	Oil Filter:	81556198 (AC 41-983)
Spark Plugs:	81556198 (AC 41-983)		
PCV Valve:	N/A	Flame Arrestor:	81525011
Plug Wires:	81756003	Distributor Cap:	N/A
		Distributor Rotor:	N/A

(Parts must be ordered through an authorized MasterCraft dealer.)



Emission Maintenance Procedures

Engine oil and filter:	<i>See Operator's Manual</i>
Spark Plugs:	<i>See Operator's Manual</i>
PCV Valve:	<i>See Operator's Manual</i>
Flame Arrestor:	<i>See Operator's Manual</i>
Spark Plug Wires:	<i>See Operator's Manual</i>
Breather Hose:	<i>See Operator's Manual</i>
Ignition Timing:	<i>See Operator's Manual</i>

**CALIFORNIA EMISSION CONTROL WARRANTY STATEMENT
YOUR WARRANTY RIGHTS AND OBLIGATIONS**

The California Air Resources Board and Indmar Products are pleased to explain the emission control system warranty on your 2003 inboard engine. In California, new inboard engines must be designed, built and equipped to meet the State's stringent anti-smog standards. Indmar Products must warrant the emission control system in your inboard engine for the time listed below provided there has been no abuse, neglect or improper maintenance of your inboard engine.

Your emission control system may include parts such as the carburetor or fuel injection system, the ignition system, and catalytic converter. Also included may be hoses, belts, connectors and other emission-related assemblies.

Where a warrantable condition exists, Indmar Products will repair your inboard engine at no cost to you, including diagnosis, parts and labor.

MANUFACTURER'S WARRANTY COVERAGE:

Select emission control parts from a model year 2003-2008 inboard engines are warranted for 2 years.

Select emission control parts from model 2009 and later are warranted for 3 years.

However, warranty coverage based on the hourly period is only permitted for outboard engines and personal watercraft equipped with appropriate hour meters or their equivalent. If any emission-related part on your engine is defective under warranty, parts will be repaired or replaced by Indmar Products.

OWNER'S WARRANTY RESPONSIBILITIES:

As the inboard engine owner, you are responsible for the performance of the required maintenance listed in your owner's manual. Indmar Products recommends that you retain all receipts covering maintenance on your inboard engine, but Indmar Products cannot deny warranty solely for the lack of receipts or your failure to ensure the performance of all scheduled maintenance.

As the inboard engine owner, you should be aware that Indmar Products may deny you warranty coverage if your inboard engine or part has failed due to abuse, neglect, improper maintenance or unapproved modifications.

You are responsible for presenting your inboard engine to an Indmar Products distribution center as soon as a problem exists. The warranty repairs will be completed in a reasonable amount of time, not to exceed 30 days.

If you have any questions regarding your warranty rights and responsibilities, you should contact the Indmar Director of Customer Service at 1-901-353-9930.

NOTE: Adjusting engine timing should not be attempted unless you have the proper tools and equipment. An improperly timed engine can be severely damaged. Do not attempt to start the engine unless the boat is in the water or an adequate supply of cooling water is applied directly to the cooling water intake.

Electronic Fuel Injected Engines

NOTE: The MasterCraft LQ9 and 8.1 Liter engines do not have adjustable timing.

1. Start engine.
2. Attach an appropriate inductive pickup timing light to the number one cylinder spark plug wire.
3. Put engine into base timing mode by running a jumper wire from pin "A" to pin "B" on the engine data link connector. The idle should automatically adjust to 900-1100 RPM.

NOTE: Due to variations in Diagnostic Scan Tools, Indmar prefers using this method of placing the ECM in base timing mode.

3. Set the timing to 10 degrees BTDC by loosening the distributor hold down bolt and rotating the distributor until the timing pointer indicates 10 degrees BTDC.
4. Remove the jumper from the data link connector. The Idle RPM should return to normal.
5. Shut the engine down and leave it off for 15 seconds.
6. Repeat steps 1-4 to verify timing.

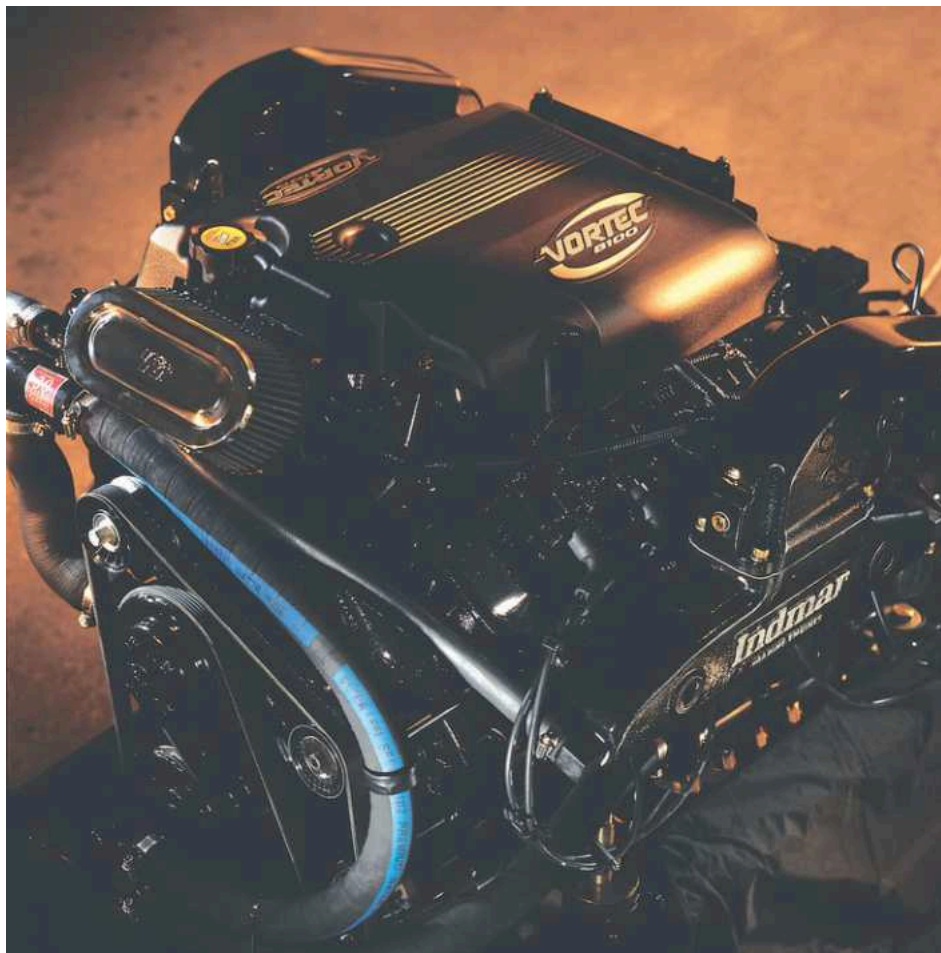

Storage and Winterization

Storage or winter lay-up requires special preparation to prevent damage to the boat. Since winter storage is an annual event, it presents an excellent opportunity to perform the annual maintenance at this time.

Without proper preparation, storage for long periods of time may cause internal parts of the engine and transmission to rust because of lack of lubrication. Also, if the boat has been stored in below-freezing temperatures with water inside the bilge or engine cooling system, including the heater or shower, this condition could result in major damage from freezing.

Note: Damage to the boat due to improper storage will void the warranty!

Also, refer to the section regarding oil changes. Your boat should have an oil change performed immediately prior to storage to prevent potential damage to your engine.

The following procedures will help avoid most potential types of damage for a period not to exceed five (5) months!



Because of the complexity of preparing your boat for proper winter storage, as well as the possibility of extreme damage to the engine if a preparation error was made during winterization, MasterCraft recommends that you schedule an appointment with your local MasterCraft dealer and permit the dealer to perform the winterization procedures.

To properly winterize your engine, you **MUST** be able to bring the engine up to operating temperature. To accomplish this, your boat must be in the water or attached to a water supply using a hose and suitable adapter that will allow an uninterrupted supply of water to the engine.

General Preparation

Before starting you will need the following supplies:

- Sta-Bil® Gasoline Stabilizer
- Six (6) quarts of specified engine oil (see engine oil change instructions elsewhere in this manual)
- Appropriate oil filter for your engine (see Specifications elsewhere in the manual or contact your dealer)
- Fuel filter
- Low tack tape
- Four to six ounces of fogging oil
- One (1) can of corrosion protectant and lubricant
- Transmission oil (if needed)
- Multi-purpose grease
- Short piece of stiff wire such as coat hanger wire
- Pipe thread sealant
- Anti-freeze tester suitable for propylene glycol anti-freeze (fresh-water cooled engines only)
- Anti-freeze (see elsewhere in this manual for more details regarding acceptable brands and specifications—NEVER mix anti-freeze types)

Fuel System Treatment

Step 1: If the boat will be placed in storage with fuel (*no alcohol in the mix*) in the tank, fill the tank with fresh fuel and a sufficient amount of Sta-Bil® gasoline stabilizer to treat the entire tank. Follow instructions on the container.

Step 2: If the boat will be placed in storage with fuel that contains alcohol, the fuel tank should be drained as completely as possible, disposed of properly, and Sta-Bil® gasoline stabilizer added to any fuel remaining in the tank. Follow the directions on the container.

Step 3: Start the engine and operate at idle until the engine reaches normal operating temperature. (*If using a hose and adapter, adjust the faucet to avoid over-cooling the engine at low RPM.*) Run the engine for at least 15 minutes to ensure that the fuel stabilizer enters the engine's fuel system.





WARNING

Running the engine with the flame arrestor removed increases the possibility of fire or explosion if the engine should backfire and gasoline fumes are present. If the engine is operated without the flame arrestor secured, extreme care must be taken to ensure that the engine compartment is well-ventilated and that no fuel leaks are present.

Step 4: Carefully loosen the flame arrestor and lift it far enough to insert the tube of the fogging oil can. Spray four to six (4 to 6) ounces of oil into the throat of the carburetor or throttle body. Shut off the engine. Re-attach the flame arrestor and seal with low-tack tape.

Step 5: Perform the annual maintenance as described in the previous chapter.

Step 6: Loosen all accessory drive belts and check their condition.

All Engines

Step 1: Drain water from the exhaust manifolds. Uncouple the hose quick-disconnect and drain the manifolds. The engine manufacturer recommends leaving the drain plugs out or the hose uncoupled until the boat is placed back in service.

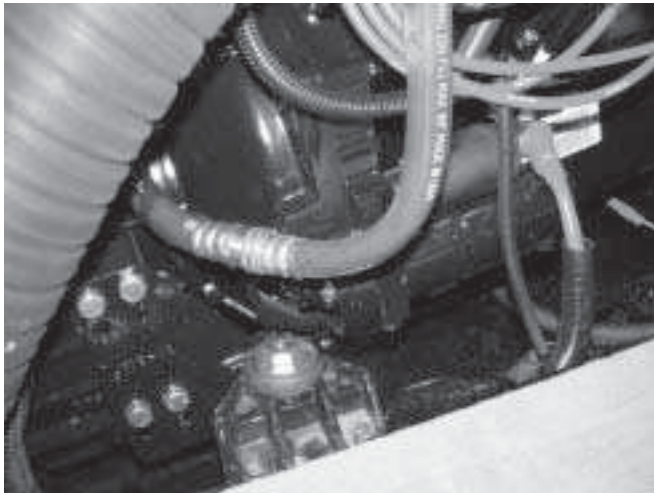

Step 2: Remove both hoses from the raw water pump on the front of the engine. Drain any remaining water from the hoses.

Step 3: Remove the raw water pump impeller from the pump housing. If the impeller shows any signs of damage or wear, discard it. If it can be re-used, lubricate the impeller with Vaseline or soap and seal in an airtight bag.

Note: It is extremely important to pay attention to the impeller during use. At any sign of wear, replace it. If you have used a single impeller throughout the season, replace it. Be certain that when the boat is placed in service the following season that you have an impeller in the raw water pump! Failure to follow these guidelines may result in nullifying your warranty!

Step 4: Remove the hose from the lower end of the transmission cooler. Inspect the cooler for any debris such as weeds, plastic pieces, etc.

Raw Water-Cooled Engines

Step 1: Remove the petcock, drain plug or sensor from each side of the engine. The engine manufacturer recommends removing the petcocks completely as opposed to simply opening the petcock drain valve.

Notice: Some 5.7 Liter engines have a knock sensor located in the drain location. The knock sensor must be carefully removed to drain that side of the block. Also, on the 8.1 Liter engine, removing the knock sensor does NOT drain the block. Remove the plugs from the brass fillings on both sides of the engine to drain water from the block.



Note: *Placing the drain plugs in a plastic bag and attaching it to the steering wheel of the boat will act as a reminder to reinstall the drain plugs during recommissioning in the spring.*

Step 2: Use a short piece of stiff wire to dislodge any rust or scale that may be around the drain hole.

Step 3: Disconnect the large diameter hose that runs from the water circulating pump to the thermostat housing. Make sure all of the water drains from the hose.



Fresh Water-Cooled Engines

Step 1: Remove the raw-water inlet and outlet hoses from the intake side of the heat exchanger.

Step 2: Check the level of the coolant on the fresh water side of the heat exchanger. Use the anti-freeze tester to test the strength of the mixture.

Notice: *A special anti-freeze tester designed to be used with propylene glycol anti-freeze is required to test the strength of the mixture.*

Step 3: If the coolant level is low, add a sufficient amount of coolant/water mix to fill the heat exchanger. Use an appropriate mix of propylene glycol anti-freeze and distilled water, mixed in accordance with the directions on the container for the anticipated temperatures.

Step 4: If the coolant in the heat exchanger is not strong enough to protect the engine to the lowest anticipated temperature, take your boat to your dealer for replacement of the coolant.

Drive Train Preparation

Step 1: Change the transmission fluid and clean the filter screen.

Step 2: Remove the attaching hardware from the propeller shaft coupling. Separate the flanges and coat the surfaces with multi-purpose grease.

General Power Package Preparation

Step 1: Clean dirt, grime and grease from painted surfaces of the engine and drive train.

Step 2: Touch up painted areas of the engine and transmission.

Step 3: Lubricate throttle and shift linkages and cables with multi-purpose grease.

Step 4: Spray the entire engine with corrosion protectant and lubricant.

Step 5: Disconnect the battery cables from the battery and charge the battery fully. If you remove the battery from the boat, store it in a cool and dry place. Never store batteries close to heat, spark or flame-producing devices.

Step 6: Leave the engine box cover propped open about two inches (2") to ventilate the engine compartment.

Other Winterization Preparations

Step 1: Remove the bilge drain plug immediately after taking the boat out of water. After a general bow-to-stern washing, raise the bow of the boat higher than the stern to allow as much water as possible to drain from the bilge, while performing other storage preparations.

Step 2: Thoroughly clean the hull, deck and interior of the boat as soon as it is removed from the water. Cleaning at this time is easier because any marine growth is still wet. Be sure to allow a few days of air drying to prevent mildew that results from trapped moisture. (See the *Cleaning* section.)

Step 3: Apply a coat of wax to the entire surface of the boat.

Step 4: If your boat is equipped with a heater, shower or ballast bags, be sure to disconnect the hoses and drain any remaining water in the lines to avoid freezing. Even small amounts of water in any of these areas can cause significant damage upon freezing and such damage is not covered under warranty!

Note: *Be sure that hoses will not become entangled in the engine V-belt when the engine turns over or the hose and/or the belt will be damaged.*

Step 5: Use duct tape to seal the exhaust flaps to prevent dirt and nesting rodents from entering.

Step 6: Cover the boat with a boat cover or tarp.

Note: If the boat is to be stored outside and subject to accumulations of snow, water and ice, a support should be made for the boat cover so that it will not sag, rip or tear, thereby allowing water to enter the boat. Two-inch PVC plumbing pipe is ideal for this purpose. It is readily available at local hardware stores, and it is easy to work with. Also, its rounded shape will prevent damage to the canvas.

Ballast System Preparations

PROSTAR 205, X-2, X-STAR, MARISTAR 210, MARISTAR 230, X-10, X-30:

Step 1: If your boat does not already have this equipment, cut 1" in front of the shut-off valve, insert a tee in the line and clamp. Insert a nipple, washer and cap.

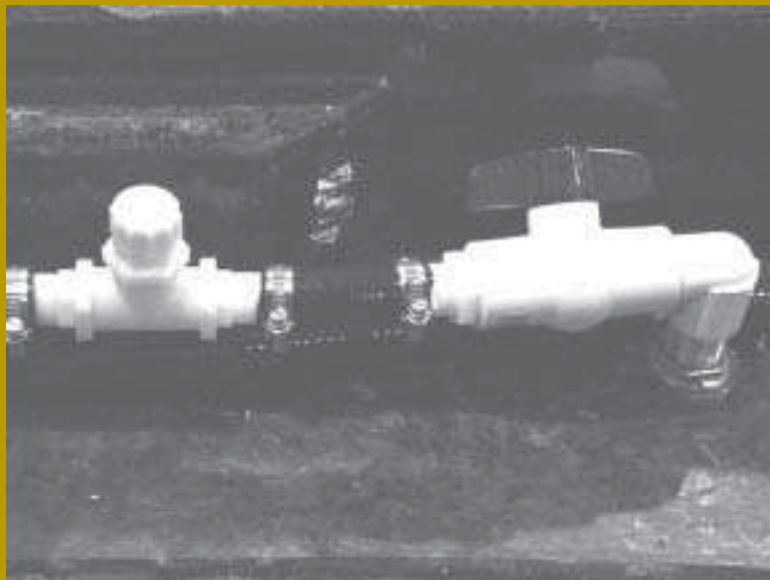

Step 2: When winterizing, remove the cap and attach the hose to the water hose fitting on the tee. Put the other end into a gallon of non-toxic, RV-type antifreeze.

Step 3: Turn on one pump to fill and pump until anti-freeze comes out the thru-hull. Then shut off.

Step 4: Repeat on all pumps.

Step 5: After placing antifreeze in all three pumps, turn all pumps to fill and pump anti-freeze into the tanks and/or bags.

PROSTAR 197, X-7, PROSTAR 209, X-9:

Step 1: Attach a hose to the starboard side ballast hose

that comes out of the deck at the rear seat.

Step 2: Place the other end into a gallon of non-toxic, RV-type anti-freeze.

Step 3: Turn the pump on to empty and pump anti-freeze into the system until anti-freeze comes out of the thru-hull on the side.

Step 4: Turn the pump on to fill and pump anti-freeze back into the jug.

Re-activating the boat after storage

Step 1: Remove the duct tape from the exhaust flaps.

Step 2: Charge and install the battery in the boat, following all safety precautions associated with changing batteries.

Step 3: Reconnect the quick-connect exhaust drain hoses.

Step 4: Re-install the drain plugs or petcocks on each side of the block. EFI engines have a knock sensor located in one of the drain holes. This unit must be re-installed in the drain hole. Carefully install this unit without any additional thread sealant. Be careful to avoid overtightening this unit. Torque specifications for installation of the knock sensor is 14-16-ft-lbs.

Step 5: Re-attach the large diameter hose to the water circulation pump.

Step 6: Re-install the transmission cooler hose connection.

Step 7: Install the raw water impeller and reconnect the hoses to the raw water pump. Use a new gasket, even if the one removed at winterization time appeared in good condition.

Step 8: Install new spark plugs.

Step 9: If applicable, reconnect the hoses to your heater or shower.

Step 10: Check the engine compartment and bilge for signs of nesting animals. Clean as necessary.

Step 11: Check the condition of the distributor cap and rotor. Replace if either shows signs of wear, damage or corrosion.

Step 12: Check the entire engine system for fluid, oil and coolant levels. Add as necessary.

Step 13: Check the entire engine for cracks or leaks caused by freeze damage.

Step 14: Check all hose clamps for tightness. Install the bilge drain plug and the rear drain plug in boats equipped with certain types of ballast systems.

Step 15: Grease the propeller shaft taper and install the propeller.

Step 16: Perform the daily maintenance. If not performed prior to storage, perform the annual maintenance.

Step 17: If the boat is equipped with the optional fresh-water cooling system and was drained for storage, fill the system with fresh coolant solution per instructions.

Step 18: Check the alignment between the output flange on the transmission and the propeller shaft flange. If the maximum feeler gauge that can clip between the flange faces at any point is 0.003", the unit is properly aligned. If a thick gauge can be inserted at any point, the engine must be re-adjusted until proper alignment is obtained. This should be performed by your dealer.

Step 19: Turn the fuel line ON-OFF valve to the ON position in models that do not have in-tank fuel pumps. For all models, with the boat in the water, cycle the key ON and then OFF 2-3 times, allowing 10 seconds between key cycles, before cranking the engine. This allows the fuel pump to prime the fuel lines; then start the engine. In the event the engine does not respond, allow a two-minute cool-down period for every 30 seconds of cranking. When the engine fires, keep a close watch over the gauge readings and check for leakage and abnormal noises. Keep speeds low for the first 15 minutes to allow the engine to reach normal operating temperature.

Step 20: In boats equipped with ballast bags, when reconnecting the hook-ups, be sure that you squeeze the prongs to help slide back on. Dish soap or some similar product will help slide the connects back together. Note that the red ring goes over the raised ring to ensure a working connection.



Unscheduled Maintenance

Propeller damage is caused by striking solid objects. If the propeller is not rotating at the time it strikes a solid object, the damage is usually confined to just one blade and may be difficult to see. If the propeller is rotating when it strikes an object, usually damage can easily be seen on all blades.

Checking/repairing propellers

Step 1: Ensure the engine is OFF and the engine safety starting switch disconnected. Place the throttle/shift control lever in forward gear.

Step 2: Clamp a small rule scale to the shaft strut, parallel to the shaft so that the end of the scale is 3/32-inches from the leading edge of a propeller blade.

Step 3: Rotate the propeller slowly. There should be no more than 3/32-inch variance between the blades. If the propeller is damaged, see your MasterCraft dealer.

To repair minor nicks and dings in a propeller (MasterCraft makes no claims to this methodology)

Step 1: Remove the propeller from the boat.

Step 2: Use a small ball-peen hammer and anvil to carefully straighten out the ding to the original contour of the blade.

Step 3: File the area to remove rough edges.

Step 4: Re-install as outlined in *Changing Propellers* instructions. If a vibration is detected, have the propeller replaced. **Do not use a propeller that is the source of a vibration. Further drive-train damage could result and this will not be covered under warranty.**



Changing Propellers

Step 1: Ensure the engine is OFF and the engine safety starting switch disconnected. Place the throttle/shift control lever in forward gear.

Step 2: Remove and discard the cotter pin.

Step 3: Remove the propeller nut.

Step 4: Tap the center hub of the propeller with a rubber mallet to release

the propeller. Inspect the shaft and propeller splines for damage.

Step 5: Thoroughly clean and apply a light coat of waterproof marine multi-purpose grease to the splined area of the shaft and propeller.

Step 6: Align the splines and carefully install the propeller onto the shaft. **DO NOT FORCE IN PLACE.**

Step 7: Install the propeller nut and torque to 50-ft-lbs.

Step 8: Install a new cotter pin and bend the ends around the shaft to lock the propeller on the shaft.



Checking speedometer calibration

For tournament use and practice, accurate speedometer readings are a must. To calibrate the speedometer you need an accurately measured course of 850 feet and a certified stopwatch accurate to a thousandth of a second. To calibrate to AWSA official-tournament rules:

Step 1: Approach the course at an indicated 36 miles per hour (MPH). Hold the speed steady and have an observer check the course time with a stopwatch.

Step 2: If the course time is between 15.88 and 16.28 seconds, no adjustment is necessary. If the course time is not within tolerance, the adjustment switch is on the lower right panel of the dash.



Troubleshooting

The following charts will assist you in finding and correcting minor mechanical and electrical problems with your boat. Problems are listed in the order of the most-likely event to the least-likely.

To correct a problem, first determine what the symptom is. Start with the first cause and eliminate the possibility of each until the problem is corrected. Because of the specialized skill and tools needed to correct major issues, we have not included that information. If you suspect a problem not addressed here, please contact your MasterCraft dealer.

If you are experiencing a problem, before shutting down your boat check your surroundings. If suddenly stopping the power would result in placing other boats in the vicinity in jeopardy, continue on until you can safely slow or stop to analyze your situation. Always be aware of your surroundings and how your actions may impact other boaters!

Problem	Possible Cause	Solution
Engine will not turn over.	<ul style="list-style-type: none"> • Safety switch tether not connected. • Throttle/shift control in gear. • Main circuit breaker open. • Battery terminal corroded. • Battery weak or worn out. • Loose or corroded battery wiring connectors. • Defective starter solenoid. • Defective neutral safety switch. • Defective starter motor. 	<ul style="list-style-type: none"> • Connect the safety switch tether. • Shift to neutral. • Re-set the circuit breaker. • Clean the battery terminals. • Charge or replace the battery. • Clean and tighten the battery wiring connectors. • Replace the starter solenoid. • Replace the neutral safety switch. • Replace the starter motor.
Engine turns over, but will not start.	<ul style="list-style-type: none"> • Safety switch tether not connected. • No fuel to the engine. • No fuel in the tank. • Fuel filter clogged. • Contaminated fuel. • Weak or shorted ignition coil. • Distributor problems. 	<ul style="list-style-type: none"> • Connect the safety switch tether. • Turn the fuel valve to ON position if boat is equipped with ON-OFF switch. • Fill the fuel tank. • Have dealer replace the fuel filter. • Drain fuel properly and have dealer replace the filter. • Replace the ignition coil. • See your dealer.
Engine is hard to start.	<ul style="list-style-type: none"> • Flooded engine. • Plugged flame arrestor. • Fouled spark plugs. • Loose coil or ignition wires. • Battery cables loose or corroded. • Weak battery. • Ignition problems. 	<ul style="list-style-type: none"> • Start the engine at full throttle and back off immediately. • Clean the flame arrestor. • Replace the spark plugs. • Tighten coil or ignition wires. • Clean and tighten the battery cables. • Charge or replace the battery. • See your dealer.
Engine misses or idles rough.	<ul style="list-style-type: none"> • Fouled spark plugs. • Loose or defective high-tension leads. • Plugged PCV valve. • Weak ignition coil. • Vacuum leak. 	<ul style="list-style-type: none"> • Have your dealer replace the spark plugs. • Have your dealer tighten or replace the high-tension leads. • Have your dealer replace the PCV valve. • Have your dealer replace the ignition coil. • See your dealer.
Poor boat performance.	<ul style="list-style-type: none"> • Fouled spark plugs. • Contaminated fuel. 	<ul style="list-style-type: none"> • Have your dealer replace the spark plugs. • Drain fuel properly and have dealer replace filter.

<i>Poor boat performance. (continued)</i>	<ul style="list-style-type: none"> • Plugged flame arrestor. • Weak ignition coil. • Fuel filter clogged. • Ignition problems. 	<ul style="list-style-type: none"> • Clean the flame arrestor. • Have your dealer replace the ignition coil. • Have your dealer replace the fuel filter. • See your dealer.
<i>Poor gas mileage.</i>	<ul style="list-style-type: none"> • Fouled spark plugs. • Plugged flame arrestor. • Inefficient driving habits. • Plugged PCV valve. • Ignition problems. 	<ul style="list-style-type: none"> • Have your dealer replace the spark plugs. • Clean the flame arrestor. • Plane the boat quickly, then slow down to desired speed. • Have your dealer replace the PCV valve. • See your dealer.
<i>Throttle/shifting problems.</i>	<ul style="list-style-type: none"> • Corroded cables. • Defective throttle return spring. • Low transmission oil level. • Sticking transmission shift detent ball. • Kink in cable(s). 	<ul style="list-style-type: none"> • Clean and lubricate the cables. • Replace the throttle return spring. • Replenish transmission fluid. • Clean and lubricate the detent ball. • Have your dealer replace the cable(s).
<i>Steering problems.</i>	<ul style="list-style-type: none"> • Corroded cable. • Rudder worn. 	<ul style="list-style-type: none"> • Clean and lubricate the cable. • See your dealer.
<i>Excessive vibration.</i>	<ul style="list-style-type: none"> • Bent strut. • Fouled propeller. • Damaged propeller. • Misaligned propeller shaft coupling. • Bent propeller shaft. 	<ul style="list-style-type: none"> • Replace the strut. • Remove objects from the propeller shaft and rudder. • Replace the propeller. • See your dealer for proper alignment. • See your dealer.
<i>Electrical problems.</i>	<ul style="list-style-type: none"> • Open circuit breaker or blown fuse. • Loose wiring connections or corrosion. • Defective sending unit. • Shorted wiring harness. • Defective switch or gauge. 	<ul style="list-style-type: none"> • Re-set the circuit breaker or replace the fuse. • Clean and tighten wiring connections. • Replace the sending unit. • Have your dealer repair the wiring harness. • See your dealer.
<i>No speedometer reading.</i>	<ul style="list-style-type: none"> • Defective speedometer. • Defective speedometer pick-up. 	<ul style="list-style-type: none"> • Have your dealer replace the speedometer. • Have your dealer replace the pick-up.
<i>Incorrect speedometer reading.</i>	<ul style="list-style-type: none"> • Improper calibration. 	<ul style="list-style-type: none"> • Have your dealer replace the speedometer.
<i>Gauges do not work or the accessory does not work.</i>	<ul style="list-style-type: none"> • Breaker has tripped. • Fuse has blown. • Low battery. • Insufficient battery supply. 	<ul style="list-style-type: none"> • Re-set the breaker. • Replace the fuse. • Check the battery voltage and for a loose ground. • Replace battery with one that has at least 750 CCAs.

The Common Sense Approach

The previous pages of this manual have been developed to help ensure an enjoyable experience as you boat, wakeboard and ski with your MasterCraft boat. As stated earlier, this information is not all-inclusive. There are many other factors to consider and additional information that you need to research before undertaking any boating.

Beyond the study involved, you should also always use common sense when boating. For example, when anchoring your boat so that you can enjoy swimming, you **MUST** turn the engine **OFF**. Exhaust fumes are emitted from the exhaust flap area of the transom, immediately below the swim platform. No one should ever be on the swim platform while the engine is in operation. Nor should individuals ever be towed while holding on to the swim platform or transom.

MasterCraft also strongly encourages individuals to wear Personal Flotation Devices (PFDs). In many states, it is a legal requirement for children to wear them. Non-swimmers of any age should never be without one.

Your MasterCraft boat can be the source of countless hours of family fun and building friendships. But it works only if YOU use your head before, during and after your boating.

Now, go out there and HAVE SOME FUN!



DANGER

Carbon monoxide is a colorless, tasteless, odorless and poisonous gas that accumulates rapidly and can cause serious injury or death. Exposure to carbon monoxide can be fatal in a matter of minutes. Exposure to even low concentrations of carbon monoxide must not be ignored because the effects of exposure to carbon monoxide are cumulative and can be just as lethal as at high concentrations. Carbon monoxide from exhaust pipes of inboard or outboard engines may build up inside and outside the boat in areas near exhaust vents. **STAY AWAY** from these exhaust vent areas, which are located at the stern of the boat, and **DO NOT** swim or engage in any watersports or other activities in or near the stern area of the boat, including, without limitation, the swim platform and the rear sun deck, when the engine is in operation. Under no circumstances should “teak surfing” or similar activities be performed during the operation of your MasterCraft boat—such activities are a misuse of this product.



Limited Warranty Statement

MasterCraft Limited Warranty Statement

I. Limited Warranty and Term.

MasterCraft warrants to the original retail purchaser that the following components of each new boat shall be free from material defects in materials and workmanship to the extent set forth below, under normal use and when operated and maintained in accordance with MasterCraft's instructions, for the period indicated:

- (a) **Deck, Hull, Liner and Stringers**—From the date of the original retail purchase, the deck, hull, liner and stringer system (collectively, "Structural Components") is warranted for as long as the original purchaser owns the boat.
- (b) **Gel Coat**—All exterior gel coat surfaces are covered against structural defects under the Limited Warranty and as listed under gel coat manufacturer guidelines. Due to the environmental and customer care effects on gel coat, cosmetic concerns must be addressed with your Customer Service representative at the dealership prior to communication with the factory. Examples are blisters, scratches, discoloration or fade issues. Stress crazing is not covered but will be reviewed as a customer good-will item on a case-by-case basis. Any issue determined to be an application/installation item will be reviewed in advance to determine warranty coverage or not. Any gel coat issues will require digital, video or 35mm photos that clearly show the reported issue.
- (c) **Engine/Transmission**—Three (3) years from the date of the original retail purchase of the boat. The engines used in MasterCraft boats are supplied by Indmar Products Company, Inc., in Millington, Tennessee ("Indmar"). Indmar's three-year warranty on the engine and transmission is administered at the MasterCraft factory and is subject to the terms and conditions set forth below under "Power Train Warranty."
- (d) **Other Component Parts**—One (1) year from the date of the original retail purchase of the boat.
- (e) **Trailer and Trailer Component Parts**—One (1) year from the date of the original retail purchase of the boat.

2. Warranty Conditions, Limitations and Exclusions.

MasterCraft boats are manufactured by trained craftspeople from high-quality materials and components. However, conditions outside MasterCraft's control require specific limitations on, and exclusions from, coverage under this warranty. The Limited Warranty on the Structural Components set forth in **Section I (a)** above does not cover or include the gel coat, including any discoloration, blisters, bubbles or cracks of the gel coat, or any other components fastened or applied to the hull or deck. Furthermore, the Limited Warranty set forth in **Section I** (including all sub-sections) above does not cover the following:

- (a) damage caused by misuse, negligence, accident, collision or impact with any object;





(b) damage caused by any improper alteration or modification to the boat or any of its component parts or accessories, including damage resulting from alteration, modification, repair or replacement in such a way as to increase the cubic-inch capacity or horsepower output of the engine and boat as originally manufactured;

(c) damage caused by the use of improper or contaminated fuel or fluids;

(d) damage caused by the use of customer-applied chemicals or accidental spills;

(e) damage caused by failure to maintain the boat in accordance with the maintenance provisions in the **Owners Manual** or improper maintenance of the boat;

(f) damage resulting from the use of the boat for any racing, speed, commercial competition or performance demonstration;

(g) damage resulting from use of the boat for rental, commercial or industrial purposes;

(h) damage to hardware and other components fastened or adhered to the hull, deck or liner;

(i) damage caused by fire, theft, freezing, vandalism, explosion, lightning, hail storms, flooding, or other natural disaster;

(j) damage to any component parts and accessories not manufactured by MasterCraft, including but not limited to the engine, drive train, transmission, propeller, shift and throttle control levers and cables, pumps, blowers, windshields, canvas, upholstery, towers and accessories, instrumentation and steering systems; however, such items may be warranted by the individual manufacturer, and if possible, MasterCraft will provide the owner with a copy of the manufacturer's warranty;

(k) damage to the gel coat due to the owner's failure to reasonably maintain the gel coat finish, including, without limitation, discoloration of the gel coat, as this condition is caused by improper care and maintenance; however, fading and chalking of the gel coat above the water line will be covered, provided the gel coat has been appropriately maintained;

(l) defects caused by improper, non-MasterCraft trailer;

(m) damage to gel coat caused by improper support of boat on davits, hoist system or boat lift of any kind;

(n) in-water storage without proper barrier coat and bottom paint;

(o) damage to the trailer and its parts or components due to abrasions, rock chips, rust, improper care or maintenance, or use in salt or brackish water; the finishes of galvanized trailers, which are designed for use in salt or brackish water, are warranted to be free from damage resulting from use in salt or brackish water for one (1) year;

(p) damage caused by dealer-installed options or accessories;

(q) damage caused by consumer-installed options or accessories;

and/or

(r) all warranted coverage will expire after ninety (90) days on boats used for commercial purposes.

3. Disclaimer of Implied Warranties.

THE EXPRESS LIMITED WARRANTY SET FORTH HEREIN IS IN LIEU OF ALL OTHER WARRANTIES AND REPRESENTATIONS, EXPRESS OR IMPLIED, AND TO THE MAXIMUM EXTENT PERMITTED BY APPLICABLE LAW, MASTERCRAFT DISCLAIMS, AND THE OWNER HEREBY EXPRESSLY WAIVES, ANY AND ALL OTHER WARRANTIES OR REPRESENTATIONS OF ANY KIND OR NATURE, INCLUDING, BUT NOT LIMITED TO, IMPLIED WARRANTIES OF MERCHANTABILITY AND FITNESS FOR A PARTICULAR PURPOSE. THIS LIMITED WARRANTY GIVES YOU SPECIFIC LEGAL RIGHTS. YOU MAY HAVE OTHERS, WHICH VARY FROM JURISDICTION TO JURISDICTION.

4. Limitation of Liability.

(a) Consequential Damages. This warranty is for the benefit of the owner and MasterCraft, and shall not create or evidence any right in any third party. To the maximum extent permitted by applicable law, in no event shall MasterCraft be liable for any special, incidental, indirect, or consequential damages whatsoever arising out of the use or inability to use the boat or any component part thereof, even if MasterCraft has been advised of the possibility of such damages or such damages could reasonably have been foreseen by MasterCraft.

(b) Purchase Price Limitation. In any event, MasterCraft's entire liability under any provision of this Limited Warranty shall be limited to the repair or replacement of the boat or component part or the refund of the purchase price paid by the customer for the boat or component part found to be defective within the applicable warranty period. This shall constitute MasterCraft's sole liability and obligation in the event of any claim arising out of its performance or non-performance of any provision of this Limited Warranty. Because some states and jurisdictions do not allow the exclusion or limitation of liability, the above limitations may not apply to you.

5. Transfer of Limited Warranty.

Upon any sale, conveyance or other transfer of the boat or trailer by the original retail purchaser, any remaining unexplored Limited Warranty coverage shall be transferred to the second owner and shall remain in effect for the remainder of the applicable warranty period(s) set forth in **Sections I (b), (c), (d) and (e)** above (which warranty periods begin to run from the date of the original retail purchase of the boat or trailer, as applicable, by the original retail purchaser), upon delivery of the warranty transfer card and payment of the applicable warranty transfer fee to MasterCraft. With respect to the Lifetime Limited Warranty (granted to the original retail purchaser) on the Structural Components set forth in **Section I (a)** above, if the sale, conveyance or other transfer of the boat by the original retail purchaser, then the warranty on the Structural Components shall be transferred to the second owner and shall



continue in effect for a period of ten (10) years from the date of the original retail purchase of the boat by the original retail purchaser. If the sale, transfer or conveyance of the boat by the original retail purchaser occurs more than three (3) years after the date of the original retail purchase of the boat, then the Limited Warranty on Structural Components (as well as all other warranties) shall be void and shall not be transferable to the second owner.

Only one (1) transfer under the provisions of this Section 5 (from the original retail purchaser to the second owner), within the applicable time period, may be made. In the event of a sale or transfer to a subsequent purchaser, all coverage under this Limited warranty shall immediately be terminated and the Limited Warranty shall become null and void. No transfer of this Limited Warranty will operate to extend the warranty periods set forth in Section 2 above. In order to effectuate the transfer of the Limited Warranty, the original retail purchaser and the new owner must properly fill out the warranty transfer card found in the back of the Owner's Manual



and deliver the completed card, together with a check made payable to "MasterCraft Boat Company, Inc." in the amount of the warranty transfer fee, via U.S. mail, postage prepaid, to MasterCraft at the address shown on the warranty transfer card. The card and check for the warranty transfer fee must be post-marked within the time period specified above in Section 5 in order for the warranty transfer from the original retail purchaser to the second owner to be effective.

6. Warranty Claims.

Subject to the terms of this Limited Warranty, any covered boat or component part with a material defect in materials or workmanship which is returned to an authorized MasterCraft repair facility or MasterCraft's factory during the appropriate

warranty period will be repaired or replaced, at MasterCraft's sole option, without charge to the owner. This provision is subject to the following terms and conditions:

- (a) MasterCraft shall be obligated only to repair or replace those items that prove defective, in MasterCraft's sole discretion, upon examination by MasterCraft's authorized personnel.
- (b) MasterCraft warrants its repairs or replacements only for the remainder of the applicable warranty period.
- (c) MasterCraft shall, in its sole discretion, fulfill its obligation to repair or replace any defective item at its factory or authorized repair facility.
- (d) The owner shall be responsible for all costs associated with the transportation of the boat, towing bills, trailer or part(s) to the authorized MasterCraft facility and for any return transportation.

7. No Modification of Warranty.

No oral or written information, advice or communication of any nature by or from MasterCraft or its representatives, employees, dealers, agents, distributors or suppliers shall create a warranty or in any manner increase or modify the scope of this Limited Warranty.

Power Train Warranty

Indmar Products Company, Inc., administers the Indmar engine warranty on marine propulsion engines sold by it (the “product”):

- A. For a period of thirty-six (36) months commencing from the date of purchase or the date of commencement of the product use, whichever occurs sooner, in the case of non-commercial use.
- B. For a period of three (3) months commencing from the date of purchase or the date of commencement of the product use, whichever occurs sooner, in the case of commercial use.

These are warranted only in the United States—excluding its territories.

A. Persons Applicable

This warranty is extended only to the original retail purchaser, except in instances of a transfer to the second owner only for a fee. Warranties of any nature to any other person are hereby specifically excluded.

B. Implied Warranties

All implied warranties of merchantability and fitness for the particular purpose are specifically limited in duration to the foregoing periods of this limited warranty. Some states do not allow limitations on how long an implied warranty lasts, so the above limitation may not apply to you.

C. Coverage

The product is warranted to be free from defects in material and workmanship under normal use and service during the period of this Limited Warranty. If the product or defective part thereof is, upon examination, determined to be thus defective, MasterCraft (Indmar) shall repair or, at its option, provide a replacement of equivalent quality (new or rebuilt, at its option).



D. Procedure

For warranty claims to be asserted hereunder, the product or defective part thereof, together with a written notice of itemized defects must be returned to the retailer from whom the product was purchased or to any other convenient Indmar dealer.

To obtain the location of an authorized dealer or service center in your area, write to Indmar requesting such information.

In the event that the local Indmar dealer is unable to remedy a warranty defect in the product, the product or defective part thereof, together with a written notice of itemized defects, must be returned to Indmar with freight and insurance charges pre-paid.

All insurance and freight charges for return by Indmar of the product (or its substitute) to the original retail purchaser shall be paid by the original retail purchaser.

Expenses for labor incurred by Indmar in the repair of any warranted products shall be paid by the original retail purchaser to the extent that such expenses for labor exceed the specified service rates of Indmar in effect at the date of receipt of the product by Indmar. A schedule of service rates of Indmar may be obtained from any authorized Indmar dealer.

E. Consequential Damages

This warranty shall not extend to consequential or incidental damages or costs incurred by the original retail purchaser. Some states do not allow the exclusion or limitation of incidental or consequential damages, so the above limitation or exclusion may not apply to you.

F. Trade Accessories

No warranty of any character is made with respect to trade accessories not manufactured by Indmar.

G. Voiding Warranty

This warranty is specifically voided and shall NOT apply under the following conditions:

- I. When the product or any part thereof is subjected to accident, alteration, abuse, misuse, neglect or improper maintenance.
- II. When the product is serviced by unauthorized persons.
- III. When damage to the product results from causes not arising out of defects in material or workmanship.

Indmar does not authorize any person, firm or corporation to alter this Limited Warranty or create any other obligation relating to the product. This warranty gives you specific legal rights, and you may also have other rights which vary from state to state.





MasterCraft Trailers

Trailering and Launching

Here are some quick tips for maintaining your trailer in tip-top condition:

- Chips in the paint, especially on the axles and frame result when these surfaces are subjected to repeated or severe hits by external objects. Usually, this is gravel or asphalt chips thrown up by the rear tires of the tow vehicles. Over time, rust may develop where paint has been chipped away and this is not covered by the trailer's warranty. To avoid this, consider attaching mud flaps behind the tow vehicle's rear tires.
- To ensure proper operation of the trailer jack, wipe it down and lubricate it on a regular basis.
- If the trailer is backed into salt water, you must completely and thoroughly wash the trailer to ensure that it will not eventually rust. Salt water is very corrosive, even on galvanized trailers and can corrode the brake system as well. Exposure to salt water can also cause brake pads to stick and malfunction.
- Check the braking system annually, along with the wheel bearings. If you find anything that appears to be worn, take the trailer to your MasterCraft dealer for a check and possible repair.
- Always approach the trailer slowly as you prepare to load your boat. This will allow you to retain greater control. Hard impact with the trailer or improper alignment on the trailer can result in damage to the boat, the trailer or both, and this is not covered under warranty. Also, if your trailer is equipped with the Boat Buddy System, a hard hit against it could cause damage, which is also not covered by warranty.
- Disc brakes on the trailer require an additional wire hook-up for the trailer lights. This wire is blue and hooks to the back-up light wire circuit on the tow vehicle. It's very important to attach this properly so that the brakes will disengage when you are backing up.

Introduction

With the purchase of your new, custom-built MasterCraft trailer you have added value to your MasterCraft boating enjoyment. You can now enjoy almost any of the thousands of recreational waterways in the country.

As the manufacturer, MasterCraft has provided you with a vehicle designed specifically for many years of

attractive, convenient, trouble-free service. Now, it is up to you to give it proper care and maintenance to be sure it will continue to perform safely and satisfactorily.

The purpose of this section of the manual is to help you do just that. Please read and follow its warnings and instructions carefully. Also, because all trailers are not exactly alike, be sure to read and comply with any warnings and additional information supplied by MasterCraft in your owners' packet. It's the best way to obtain peak performance.



WARNING

Before towing this trailer, be sure to read and familiarize yourself with this section of your manual.

A Proper Match

The key to carefree boat trailering is the proper match of boat to trailer. This proper match is only one reason why the MasterCraft engineering department has designed your trailer to carry the full weight of your boat, engine and gear. It also provides the proper support for the boat hull during storage.



WARNING

The total weight of your boat, engine, fuel, water and gear must not exceed the trailer's maximum load-carrying capacity. Overloading can cause serious injury or property damage. Note: Maximum load-carrying capacity is the Gross Vehicle Weight Rate ("GVWR") less the weight of the empty trailer.

Load-Carry Capacity

Check the metallic certification label attached to the left, forward side of your trailer. It will show the maximum load-carrying capacity of the trailer. It will also show the Gross Vehicle Weight Rating (GVWR), which is the load-carrying capacity plus the weight of the trailer itself. **Be sure that the total weight of your boat, engine, gear and trailer do not exceed the GVWR.**

Be especially careful to avoid overloading your trailer by putting heavy baggage, camping gear, etc., inside the boat.

Don't tow the boat with a water-filled bladder for wakeboarding. Empty the contents or the tongue weight will be incorrect.

Don't tow the boat with wakeboards left on the board racks. Doing so may void your warranty and cause damage to your boat or to vehicles following behind you as boards and/or racks may become disengaged.



WARNING

Trying to tow with water-filled bladder(s) may not only cause the total weight limits for the trailer to be exceeded but may also result in the improper distribution of the weight on the trailer thereby making towing difficult and/or causing instability when towing, which can be very dangerous to you and to other motorists. You should NEVER tow with water in the ballast bladders or tanks!

Weight Distribution

Improper weight distribution can cause a boat trailer to fish-tail (*sway from side-to-side*) as it moves down the highway, putting excessive strains on both trailer and towing equipment, increasing gas consumption and sometimes causing an accident. The most effective way to guard against fish-tailing is to make sure the weight load on your trailer is properly distributed.

It is extremely important that 5-to-10 percent of the total weight of your trailer should be felt at the trailer coupling ball when the tongue is parallel to the ground. A bathroom scale can be used for this determination.

For example, if the gross weight of the trailer, boat and gear is 3,000 pounds, the weight on the tongue should not be more than 300 pounds, but not less than 150. (*Some auto manufacturers say that tongue weight should not exceed 200 pounds when using a weight-carrying, bumper-mounted hitch with full-sized cars.*)

The importance of an adequate download on the hitch ball cannot be over-stated.

The Trailer Hitch

There are two basic types of trailer hitches: A weight-carrying hitch and a weight-distributing hitch. A weight-carrying hitch is recommended for your MasterCraft. Before deciding which type of hitch to use, also consult your automobile manufacturer on recommendations for your car or truck.

Be sure that the total weight of your trailer-boat rig does not exceed the hitch's load capacity. The maximum weight it can handle is stamped on the hitch. Also, be sure the hitch ball is the correct size to match the coupler on your trailer. The correct ball diameter is marked on the trailer coupler. The hitch also should provide a place for attaching the trailer's safety cables—two rings or holes on either side of the hitch ball.

A truck or van using a step bumper as the hitch platform will need to have safety cable attachments such as eye-bolts, as well as a hitch ball, installed according to the Society of Automotive Engineers; SAE J684 Standard. Installing a light or heavy-duty hitch can be a major undertaking. The hitch and its installation should meet the SAE J684 Standard. It is recommended that you have the job done by a professional. Your dealer can advise you.

To ensure that the boat is riding properly on the trailer supports, the trailer should be in a level position when hitched to the tow vehicle. The recommended height of the hitch ball, according to the NMMA, is 16-to-20 inches to the top of the ball from the ground. More importantly, failure to adjust to this height may prematurely activate the surge brakes.

This can be corrected in a number of different ways. For example, you may install air-pressure adjustable shock absorbers on the tow vehicle, or switch from a weight-carrying hitch to a weight-distributing hitch. Again, consult with your tow vehicle dealer.

In general, for Class 3 rigs (3,500 to 5,000 lbs.), a two-inch (2") ball is the requirement. For Class 4 (5,000 to 10,000 lbs.), a ball of either 2" or 2-5/16" will be required.



Serious injury or death or property damage can result if the total weight on your loaded trailer exceeds the capacity of the hitch on your tow vehicle.

Safety cables

The safety cables on your MasterCraft trailer provide added insurance that it will not become detached from the towing vehicle when underway. Before each trip, you should make sure that the proper cables are correctly attached between the towing vehicle and the trailer.

As noted above, your trailer hitch should provide a place for attaching safety cables, through holes or rings on both sides of the hitch ball. It is strongly recommended—and in fact, most states require it—that you criss-cross the cables under the trailer tongue. The cables on the left side of the trailer tongue should be attached to the hole or ring on the right side of the hitch ball, and the right cable should be attached to the hole or ring on the left side of the hitch ball. This will prevent the trailer tongue from dropping to the road if the trailer coupler separates from the hitch ball.

The cables should be rigged as tight as possible, with just enough slack to permit tight turns. If for any reason you should find it necessary to replace a safety cable, do not substitute with any part other than a genuine MasterCraft cable.

Note also that late-model trailers are equipped with a surge brake break-away cable. This should be attached to the tow vehicle, making sure there is enough slack for tight turns.



Failure to properly attach the safety cables between your trailer and the tow vehicle can result in a run-away trailer if the trailer coupler becomes detached from the hitch, which may cause serious injury or death or property damage.

Trailer Winch Assembly

Upon each use of the winch, check for the proper ratchet operation. Do not use the winch if it is damaged. Seek immediate repairs.

Maintain a firm grip on the winch handle at all times. Never release the handle when the ratchet lever is in the unlocked position with a load on the winch. The handle will spin violently under these conditions, which could cause personal injury.

Never use the winch handle as a handle for pulling or maneuvering the entire trailer or other equipment. Never pull on the winch handle against a locked ratchet.

Never exceed the rated capacity of the winch. Excessive loads may cause premature failure and result in personal injury.

Never apply a load on the winch with the strap fully extended. Keep at least two full turns on the strap that's on the reel.

Inspect the condition of the winch strap. Using one that is damaged or worn can result in serious personal injury or damage.

It is not recommended to use the winch as the sole method for loading the boat onto the trailer. However, it is a satisfactory assistant in the event of engine power loss.

Check the winch straps frequently. The strength in these can deteriorate from exposure to weather, ozone and ultraviolet light. If a strap becomes frayed or worn, replace it immediately with a new one.

A heavy grease should be applied to the gears to provide a free-running drive and to minimize the effort you have to expend to crank the boat on the trailer.

Warning on Tongue

Attention should be paid to all warning labels. Pay particular attention to the warning labels that appear on the pivot tongue.

MasterCylinder Level

Regularly verify that the brake fluid level comes to the top of the reservoir. **MasterCraft specification for brake fluid is type DOT3 Premium.**

As part of an annual maintenance program, consumers should check the fluid level both at the beginning and at the conclusion of the boating season. If at any time you suspect a braking issue, check the fluid level.

Trailer Coupling

Your trailer coupling is designed to have the required strength when a hitch ball is in its socket. It is therefore necessary to exercise care when the trailer is disconnected from the hitch that the coupling is not subjected to any impact.





Failure to properly engage the hitch ball in the coupler ball socket and to securely lock the coupler latch mechanism can cause the trailer to become detached from the tow vehicle while traveling, which may cause serious injury or death or property damage.

The coupling should not be allowed to lay on the ground where dirt or sand can enter the socket. This can cause excessive wear when the trailer is towed again, or it can cause the locking mechanism to jam.

If the coupler becomes damaged it must be repaired or replaced before towing. When the coupling is placed on the ball, the latch should close firmly. Keep the latch mechanism lightly oiled and clean. **Always install a lock pin in the coupler to promote safety.**



To reduce the risk of serious injury, death or property damage, make certain that all the trailer lights are in proper working order.

Lights

A special wiring harness for connecting the trailer lights to the lighting system of the tow vehicle comes with your trailer. Be sure the white ground wire from the connector is attached to the frame so that the hitch ball does not have to act as an electrical connection. Always have your light plug hooked up when backing your trailer. Disc brakes will not release without the special connector wired to your back-up lights on your tow vehicle.

Note: Some late-model cars have yellow turn signals and separate (red) stop lights. In this case, a special wiring adapter will have to be installed on the automobile.

Here are a few things you can do to keep your trailer lighting system in good working order:

- Be sure the white ground wire is properly connected to the trailer frame. Replace any parts that are damaged or badly worn.
- A small amount of waterproof grease on the plug contacts and light bulb bases will help prevent rust and corrosion.
- Before every trip, check for burned-out or broken bulbs, cracked or broken light lenses, etc.
- Be sure to unplug the light each time before backing into the water. Extra plugs are available from your MasterCraft dealer.

Wheels and Hubs

Because they are often exposed to water, trailer wheels and tires require more attention than the wheels on your family car. The three major items to check are lug nuts, lubrication and the tire pressure.



Maintain the proper torque on the lug nuts attached to the wheel bolts. Failure to do so may result in serious injury or property damage. Your MasterCraft dealer can provide you with the proper torque specifications (measured in foot-pounds).

WARNING

Also keep the wheel bearings lubricated. Failure to do so may cause failure and possible wheel loss, which may result in serious injury or death or property damage.

As part of the regular maintenance, keep the axle assembly properly lubricated. This procedure is best performed by your MasterCraft dealer. The fill plug in the hub nose must be removed so that 80- to 90-weight motor oil can be added. "Never-seize compound" is applied to the fill plug, which is re-installed and torqued to 7-ft-lbs.

Lug Nuts or Wheel Bolts

Loose lug nuts can cause more than just an annoying wheel wobble—you could lose a wheel. Before each trip check for loose or missing lug nuts/wheel bolts.

When tightening the lug nuts, use the correct sized-wrench. The wrong size can round-off the lug nuts and render them useless. If you lose a lug nut, replace it promptly. The correct size varies with different models, so you should verify the information with your MasterCraft dealer.

Take special care to ensure that the replacement lug nut is the correct type. While the threads of the lug nut may match, it may be a size that does not hold the wheel securely against the hub, even when fully tightened. Be certain a replacement lug nut is an exact match for the original.

Use the following pattern to tighten lug nuts. **On first torquing pass: Bring up to 45-ft-lbs. On second pass: Bring up to 70-ft-lbs. On third pass: Bring up to 90-ft-lbs.**

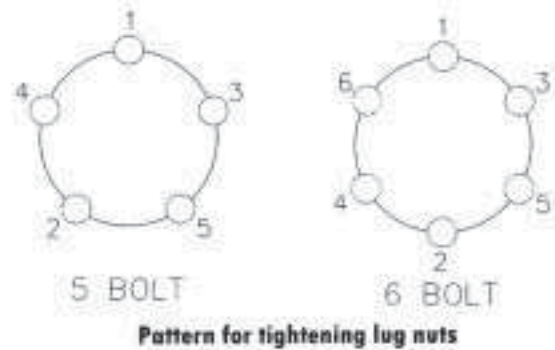

Lubrication

Currently, trailers feature oil-bath bearings. Earlier models were equipped with easy lubricating hubs. However, water invades and seeps through the smallest opening. When a warm hub is submerged in cold water, any air inside the hub will contact and draw water through the best of seals.

Trailers equipped with the Bearing Buddy II with Auto Check simplify the process of keeping watch for proper lubrication. If the blue ring is fully extended (about 1/4-inch extruded), you have adequate lubrication. As the grease dissipates, the ring will move back into the shell. When the blue ring is flush with the Bearing Buddy shell, it is time to re-lubricate.

Your best protection against wheel bearing damage from the water is to always keep your wheel assembly properly lubricated. If the wheels have been in the water, the bearings should be re-packed if the trailer remains unused for two weeks or longer. When on a trip, make it a habit to check the wheel hubs every time you stop for gas or refreshments. If the hub feels abnormally hot, the bearings should be inspected before continuing your trip.



Wheel Bearings and Braking System

Wheel bearings and the braking system on the trailer should be inspected annually. If the bearings or race show signs of scoring, they should be replaced, as well as worn brake parts. Your MasterCraft dealer should perform this inspection and repair.



WARNING

Keep your tires properly inflated. Failure to maintain the correct pressure may result in tire failure and loss of control, which may result in serious injury or death or property damage.

Tires

The most common cause of trailer tire trouble is under-inflation. It is important, therefore, that you always maintain correct air pressure as indicated by the tire manufacturer on the tire's sidewalls. Always check the air pressure when the tires are cold. Tires heat up and the air pressure increases after traveling short distances. Inflate tires to the proper air pressure as noted on the sidewall of the tires.

When your trailer tires become worn or damaged, replace them with new tires. Your MasterCraft dealer can help you.

For safety and convenience, it is recommended that you always carry a spare wheel and tire.

Brakes

In most states, trailers with a Gross Vehicle Weight Rating (GVWR) of 1,500 pounds or more are required by law to have brakes on all wheels. (Auto manufacturers generally recommend brakes even with lighter trailers.)



WARNING

Trailer brakes must be maintained in good working condition. The loss of adequate braking could result in serious injury or death or property damage.

Your MasterCraft trailer brakes are designed to operate automatically when the tow vehicle's brakes are applied. These are known as surge brakes. When the tow vehicle slows down or stops, the forward momentum (*surge*) of the trailer against the hitch ball applies pressure to a master cylinder in the trailer coupler. This pressure activates the trailer brakes through a hydraulic system, much like the brakes on your automobile.

Try out your brakes before each trip. On a regular basis, have your brake linings inspected, necessary adjustments



made and any damages or worn parts replaced.

Wet brakes usually do not hold especially well. If your wheels have been in water, several brake applications at slow speeds should dry them out.

Trailer Jack

MasterCraft recommends using the jack to lift the coupling of a loaded trailer from the hitch ball and for moving the trailer about when it is disconnected from the towing vehicle. The trailer jack should be lowered to a minimum position and tilted horizontally before moving the trailer.

Like any mechanical assembly, a jack requires maintenance to function properly over a long period of time. The drive gear and the rack-and-pinion should be greased. The caster and wheel bearing should be oiled frequently.

Tie-Downs

Ensuring that your MasterCraft is held securely in place on the trailer's hull support, especially when underway, is extremely important. If it is not firmly and properly secured, your boat can be damaged as it bounces against the hull supports.

MasterCraft's Boat Buddy System is located on the winch stand. Ask your MasterCraft dealer to demonstrate the proper use of the Boat Buddy System. A separate winch strap is provided and should then be attached to hold the boat down on the trailer. Besides keeping your boat from sliding off the rear if the Boat Buddy latch would fail, it will keep the boat on the trailer during quick stops or minor collisions.

As noted previously, it is very important to be sure that the transom of your MasterCraft boat is resting fully and securely on the supports provided at the rear end of the trailer, and that it remains in place when parked or underway.

Tie-downs have been added on both bow and transom of the boat.

Hitching Up

- Hitch only to the ball size marked on the coupling.
- Be certain the ball clamp captures the ball and lever or the handwell is fully closed or tightened. Insert safety pin or optional lock pin.
- Cross the safety cables under the coupling.
- Allow only enough slack in the safety cables to handle turns. When hitching your trailer, you should always observe each item of the "Trailer Check List." Hitching your trailer to your tow vehicle can be a one-person job, but it is easier if you have a second person to help you.

Here are the basic steps:

- Back your tow vehicle as close as possible to the trailer. It's easier—and safer—than pulling the trailer to your car or truck.
- Check to be sure the coupler-locking device is released.
- Raise the front end of the trailer with your jack, position the coupler directly over the hitch ball and lower until it is all the way down over the ball.
- Check under the coupling to be certain that the ball clamp is below the ball and not riding on top of the ball.
- Lock the coupler to the hitch ball. To be sure it is in the locked position and securely in place, raise up on the trailer tongue. If it comes loose





from the ball, unlock and go back to the third step above.

- Be certain the jack is in the fully raised and locked position.
- Your MasterCraft trailer has a surge brake-away cable. Attach it to the tow vehicle, making sure there is enough slack for tight turns.
- Attach the safety cables.
- Connect the trailer wiring harness to the lighting system of the tow vehicle and check the operation.

Trailer Techniques

With a boat trailer in tow, you are operating a vehicle combination that is longer, heavier and sometimes wider and taller than your car or truck. This means you will have to make a few adjustments in your normal driving practices to compensate for the difference. Here are a few tips to help you enjoy trailering:

- **Take a shakedown cruise.** Before you make your first major trip or first trip to the lake with your trailer, make at least one short trial run to familiarize yourself with its handling characteristics. Be sure everything is working properly.
- **Slow down.** There is less strain on your car, trailer and boat at moderate to slow speeds. Also, many states have lower speed limits for vehicles towing trailers.
- **Allow extra time and space.** You'll need more of both when passing and stopping.
- **Check the rear view mirrors.** Install outside rear view mirrors on both sides of the tow vehicle. Make it a habit to check the mirrors at frequent intervals to be sure your trailer and boat are riding properly.
- **Swing wider.** Trailer wheels are closer to the inside of turns than the wheels on your car or truck.

This means you should swing wider at curves and corners.

- **Pass with extra care.** With a trailer in tow, you'll need more time and distance to accelerate, get around a slower vehicle and return to the right lane.
- **Watch the wind.** Be prepared for sudden changes in air pressure and/or wind buffeting when larger vehicles pass you from either direction. Slow down a little and keep a firm hand on the steering wheel.
- **Conserve fuel.** Wind resistance against the boat and trailer can reduce your gas mileage significantly, especially at higher speeds.
- **Avoid sudden stops and starts.** Even though your trailer has brakes, a sudden stop can cause it to skid, slide or even jack-knife. *(Be especially careful to avoid the necessity for quick stops while turning.)* Smooth, gradual starts and stops will improve your gas mileage and put less strain on your tie-downs, etc.
- **Signal your intentions.** Well before you stop, turn, change lanes or pass, use your light signals to let other vehicles know what you intend to do.
- **Shift to a lower gear.** If your tow vehicle has a manual transmission, traveling in lower gears when going up steep hills or over sand, gravel or dirt roads will ease the load on your engine and transmission. If your tow vehicle has an overdrive gear (*manual or automatic*) you may get better gas mileage in a lower gear. Check the automobile's owners manual for their recommended towing specifications.
- **Always be courteous.** Make it as easy as possible for faster-moving vehicles to pass you. Remain in the slower lane and be prepared to slow down if they need extra time to return to their proper lane.
- **Don't tailgate.** Allow at least one combined car-and-trailer length between you and the car ahead for every 10 MPH you are traveling.

If a problem occurs, the general rule is to stay calm. Don't panic and don't do anything any more suddenly or violently than you have to.

A sudden bumping or fan-tailing may be a flat tire. Don't jam on the brakes or mash the accelerator to try to drive out of it. Stop slowly and in as straight a line as possible. If conditions permit, allow your rig to coast at a very slow speed and try to avoid braking, except when your wheels are straight ahead and the trailer and tow vehicle are in line.

If your trailer begins to fish-tail as you accelerate to highway speed, back off a little and it should cease. If it begins again as you accelerate, stop and check your load. If it is not evenly distributed side-to-side, or it is too far back so that the hitch load becomes too low, the result can be this condition. Re-distribute the load before continuing.

Launching

Every MasterCraft owner develops their own favorite launching technique. Until you do, here are a few helpful tips:

- **Check the ramp first.** Whether you're launching from an unimproved or surfaced ramp, check it out before starting your launching procedure. How steep is it? Is the surface firm enough to support the weight of the trailer rig and tow vehicle? Is it wide enough? How deep is the water at the end of the ramp?



Some launch ramps may be slippery when wet. Use great care when walking, standing or loading and unloading boats on or around any launch ramps.

- **Prepare for launching.** Install your drain plugs and detach the trailer tie-downs.
- **Back your trailer down to the ramp.** If possible have someone stand to one side of the ramp to direct you. Backing up a trailer can be tricky. A good way to simplify the procedure is to grasp the steering wheel with one hand at its lowest point (6:00). When you want the trailer to go right, move your hand on the wheel to the right; to make the trailer go left, move your hand to the left.
- **Back your trailer into the water until the trailer tire wheel well is about two inches from the top of the water surface.** Set the parking brake and shift into park (*automatic transmission*) or first gear (*manual transmission*). Shut off the engine. Unlock the Boat Buddy latch and winch hook; then back the boat off the trailer.

To re-load the boat on the trailer, simply reverse the above procedures, including setting your Boat Buddy latch to the proper position, and drive your boat on the trailer at a slow pace. Before loading, we recommend you clean any dirt or sand off the rollers and bunks. Sand on these can abrade the boat's bottom while trailering.

Be certain all the boat tie-downs are properly fastened before departing from the launching ramp area.



Wet brakes may not hold and/or may cause brakes to have diminished performance characteristics. A few braking applications at a slow speed will help to dry them out, but extra care must be used when braking after brakes have become wet.

Storage

When your MasterCraft trailer will not be in use for several months, you can help it continue to give you good performance by taking the following steps:

- If at all possible, park your boat-trailer rig in a protected area such as a garage, carport or similar shelter.
- If you must park the trailer outdoors, install a boat cover that is tight enough for adequate protection but not air-tight.
- Service or re-pack the wheel bearings.
- Jack up the trailer and place blocks under the trailer frame to take most of the weight off the trailer springs and tires.
- Loosen the tie-downs and winch strap, but be sure the boat is still resting properly on the hull supports.
- Remove the drain plug and elevate the trailer tongue slightly (*just an inch or two*) to allow water to drain out so the boat will be dry. Tie the plugs to something obvious—like the steering wheel—so you will remember to replace the drain plugs before your next trip.
 - A good time to touch up rust spots, nicks and chips is when the trailer is in storage.



- Replace damaged tie-downs, winch straps, wiring, etc.
- Lubricate moving parts such as the rollers and winch, as well as the ball coupler.
- Tighten any loose nuts and bolts.

Trailer Tips

- The jack and lug wrench that came with your tow vehicle may also work on your trailer, but don't count on it! Check to make sure.
- Your trailer will look better and last longer if you rinse it off with fresh water several times a year. If your boat is in brackish or salt water, the trailer should be rinsed thoroughly after every trip. An annual washing with a mild detergent and waxing with an auto wax also will help to keep your trailer bright and clean.
- Make up a special Boating Kit and carry it with you on all trips. The kit should include a spare wheel and tire, lug wrench, wheel chocks, bearing grease, spare strap for tie-downs and winch, extra lights, wheel bearings and road flares.
- Some insurance policies do not provide coverage when towing a trailer. Check your policy, or call your insurance agent to be sure you are fully covered.

Trailer Check List

Never tow this trailer before you check to be sure:

- Coupler, hitch and hitch ball are of the same size.
- Coupler and safety cables are safely secured to the hitch.
- Check all fasteners for proper tightness.
- The boat is securely anchored to the trailer. **(The winch strap is not a satisfactory tie-down!)**
- The wheel lug nuts are properly tightened.
The wheel bearings are properly adjusted and maintained.
- The load is within the maximum load-carrying capacity of both the trailer and the tow vehicle.
- The tires are properly inflated.
- All trailer lights are working properly.
- Trailer brakes are properly adjusted and working, if the trailer is so equipped.

This trailer is manufactured to meet the applicable federal safety standards. Check the local and state requirements regarding any additional equipment that may be required.

Note: Trailer laws covering such things as brakes, lights, safety cables, licenses, etc., will vary from state to state. Be sure that your trailer is in full compliance with applicable state laws. Your MasterCraft dealer can help you in this regard. Otherwise, contact your nearest state motor vehicle department.

GMP: Genuine MasterCraft Parts

Recognizing the pride that MasterCraft owners take in their boats, MasterCraft has been diligently working to develop our own line of products designed specifically to ensure a better-looking, longer-lasting product.

Your 2004 model ProStar, X-Series or MariStar boat is just the third full model year to be able to utilize these products. As you maintain your boat over the coming years, use Genuine MasterCraft Parts (GMP) to keep the pride!

MasterCraft Marine Motor Oil

The life of your marine engine is dependent upon proper lubrication. That is why we've developed the MasterCraft Marine Motor Oil. This premium marine motor oil was formulated specifically for MasterCraft Boat Company for use in high performance marine engines. The oil provides high viscosity and film strength for engines protection in high-load applications. You cannot get the same formula in any other engine oil!

MasterCraft oil is designed to protect against corrosion, wear, oxidation, varnish and sludge deposits. When used as directed in the *Owners Manual*, this oil assures compliance with MasterCraft warranty requirements. MasterCraft Marine Motor Oil is an exclusive product available only through genuine MasterCraft dealerships!

MasterCraft Premium All-Purpose Cleaner

Most MasterCraft boat owners pay attention to the details, especially when it comes to the maintenance and life of the boat interior. We give you information in the *Owners Manual* on how to extend the life of the boat interiors. We especially caution to avoid certain household cleaners, powdered abrasives, steel wool and industrial cleaners that can cause damage and discoloration. Dry cleaning fluids and lacquer solvents should not be used because they will remove the printed pattern and gloss.

No cleaner can remove every mark or stain, but we provide a table in the manual that tells the owner what to use and how to treat many stains. For regular maintenance, however, we've never told you what to use—only what not to use. Now, with this new product, MasterCraft Premium All-Purpose Cleaner, you can do it right!

A powerful foam cleaner that cuts through grease, dirt and grime, the foam clings to vertical surfaces and penetrates through dirt that accumulates. MasterCraft Premium All-Purpose Cleaner is an exclusive product available only through genuine MasterCraft dealerships!

MasterCraft Premium Shine & Protectant

After boat owners get the interior surfaces clean, they like to have a product that will help keep everything looking ship-shape. Waxes are not recommended for interior surfaces because many contain dyes or solvents that can permanently damage the protective coating. That's why MasterCraft developed our own Premium Shine & Protectant to guard against ultraviolet rays, environmental conditions and everyday use, while adding years of life and beauty.

This product penetrates, protects and beautifies. It contains no fluorochemicals either. MasterCraft Premium Shine & Protectant provides a protective shield that gives a long-lasting appeal for plastic, plexiglass, vinyl, rubber, acrylics, Formica, wood and leather—so it can be used on more than just the boat!

For best results, consumers should leave the Shine & Protectant on surfaces for several hours or overnight before removing excess. This product is available only through genuine MasterCraft dealerships!

MasterCraft Premium Marine Wax

If you take great pride in the appearance of your boat, by using MasterCraft Premium Marine Wax you help ensure a long-lasting and attractive shine for the deck and hull. This pre-softened formula combines carnuba wax with efficient cleaning agents that remove oxidation, engine exhaust spill-off and other contaminants.

MasterCraft Premium Marine Wax provides a deep gloss with long-lasting protection from UV rays, salt air and harsh weather conditions. It's great for fiberglass, gel coat, aluminum, chrome and painted surfaces.

This product protects and inhibits color fading and cleans effectively without harmful abrasives, leaving a beautiful glossy shine. It protects against harsh weather conditions, too. Using this GMP product will assist boat owners in following the requirements outlined in the *Owners Manual* for providing protection over the life of the boat.

MasterCraft Premium Marine Wax is an exclusive product available only through genuine MasterCraft dealerships!

Talk to your dealer about other MasterCraft products available for your boat. And remember: You bought the best...now keep it that way!



Warranty Transfer

For first purchase of a specific MasterCraft boat, the original owner will receive a warranty registration card to complete and turn in. You should be aware that under federal law, completion of the warranty card is a requirement and should be completed as follows:

1. Dealer must complete the warranty registration at date of sale.
- 2. Dealer must secure buyer's signature!**
3. Dealer provides a copy to the buyer, retains a copy for dealership files and forwards the remaining copy to MasterCraft.
4. Card must be mailed to the manufacturer within three days of the sale.

If the MasterCraft boat is subsequently sold, MasterCraft offers a transferrable warranty to the second owner. In accordance with the MasterCraft Limited Warranty, the remaining warranty against structural defect in the hull and deck will be transferred to the new owner when the following has been accomplished and verified:

- Receipt of the completed form below.
 - Copy of the sales invoice.
 - Payment of \$450 within fourteen (14) days of the sale date.
- Upon verification, the remaining warranty will transfer, retroactive to the sale date.

WARRANTY REGISTRATION TRANSFER (forward this copy to MasterCraft)

Boat Serial Number _____ Model No. _____

Engine Make	Serial No.	Trans. Type	Serial No.
_____	_____	_____	_____

PLEASE PRINT

Previous Owner _____

New Owner's Name _____

Street Address _____

City _____ State _____ Zip Code _____

Home Phone _____ Business Phone _____

Date of Purchase _____ Owner Signature _____

(Must be signed!)

Be sure to enclose payment and a copy of the purchase receipt within 14 days of the sale date.

Welcome to the Wonderful World of Team MasterCraft

Purchasing a new MasterCraft ProStar, MariStar or X-Series boat has the added benefit of automatic one-year membership in the fun that is Team MasterCraft. And your membership will be renewable in succeeding years, too.

No other manufacturer offers so much in terms of product, customer service, an outstanding dealer network and just pure fun by keeping other boat owners like you informed in print and online, and bringing you together in social settings.

As a member of the exclusive Team MasterCraft, you will receive:

- A Team MasterCraft tee-shirt.
- A membership kit filled with custom Team MasterCraft items.
- A personalized membership card and certificate.
- A year's subscription to *STAR*, the official MasterCraft owners' magazine.

You'll also be invited to special events around the country throughout the year.

Among the national, regional and local events about which you'll learn more and be invited to attend are the Water Ski Pro Tour, Regional Amateur Championships, and Master-Craft Reunion events. At most of these, you'll also be allowed into restricted areas set aside for Team MasterCraft, with excellent views of on-water events, and lots of opportunities to compare notes with other Team members, admire each others' boats, compete for prizes and have a wonderful time.

As sponsor of many events and a Pro Team of skiers and wakeboarders, MasterCraft is hands-on in the sport. You'll have opportunities to meet, receive autographs from and talk to some of the top stars. You'll also take pride when you see MasterCraft boats pulling events on television—and even in the movies!

MasterCraft will also alert you to very special events, such as Camp MasterCraft, where “kids” of all ages attend to learn more about skiing and wakeboarding. You can keep track of everything by logging on to www.mastercraft.com, and checking out all the exciting events going on around the country for Team MasterCraft members!

