

**OWNERS
MANUAL
“1989” – “1991”
MARISTAR**

89-91

WELCOME ABOARD!

Congratulations on your choice of the finest ski boat available. MasterCraft is the recognized leader in ski boats today and has been for more than 20 years. The quality, innovation, selection, and value are unmatched in the industry. Take a few minutes to read this manual completely before you use your boat for the first time, it will answer any remaining questions you may have.

Every effort has been made to make this manual accurate. All information is based on the latest product information available at time of printing. Because of our policy of continuous product improvement, we reserve the right to make changes at any time, without notice, in specifications and models and also to

discontinue models. This right is also reserved to change specifications, parts, or accessories at any time without incurring any obligation to equip same on models manufactured before the date of the change.

The continuing accuracy of this manual cannot be guaranteed. The illustrations used in this manual may not depict actual model component parts or equipment and are intended only as representative reference views. Along with this manual is information about on board components furnished by suppliers other than MasterCraft.

TABLE OF CONTENTS

WELCOME ABOARD!	1	Shifting Gears	17
Construction and Standards	2	Engine Warning Alarm	18
Standard Features	2	Stopping	18
Certification	2	OPERATIONAL HINTS	18
Serial Number Locations	2	General	18
SAFETY	3	First Time Operation	19
General Precautions	3	Basic Maneuvering	19
Safety Equipment	4	High Speed Operation	20
Safety Afloat	5	Unusual Operating Conditions	20
Skiing Safety	6	LIFTING THE BOAT	21
GENERAL LAY-OUT	7	CORROSION	22
CONTROLS AND INDICATORS	9	CLEANING	22
Gauges	9	SCHEDULED MAINTENANCE CHECKS	
Switches	9	AND SERVICES	23
Circuit Breakers	10	Frequency and Scheduled Maintenance	
Circuit Breakers	10	Task Table	23
FUELING	11	Check Engine Oil Level	24
LAUNCHING/LOADING	12	Check Transmission Fluid Level	25
SAFETY CHECKS AND SERVICES	14	Check Cooling System Level	25
Before Each Operation	14	Check Engine V-Belts	25
During Operation	14	Check/Service Fuel Filter	25
After Operation	14	Inspect Engine Hardware	26
NEW BOAT BREAK-IN	14	Inspect Throttle/Shift Cables	26
STARTING AND BASIC OPERATION	16	Inspect Battery	26
Before Starting	16	Inspect Exhaust System	26
Starting the Engine	17	Inspect Propeller Shaft Log	27
		Inspect Fuel System	27
		Change Engine Oil	27
		Lubricate Engine Starter	28
		Change Engine Oil Filter	28
		Clean Engine Flame Arrestor	28
		Clean Carburetor Fuel Screen	28
		Replace Fuel Filter Element	29
		Clean Fuel Tank Pick-Up	29
		Engine Tune-Up	30
		Change Transmission Fluid	30
		Check Shaft Coupling Alignment	30
		Lubricate Steering System	30
		Lubricate Shift/Throttle Cables	31
		Inspect Exhaust Flaps	31
		Check Engine Mounts	31
		Inspect Complete Fuel System	31
		UNCHEDULED MAINTENANCE	32
		Changing Propellers	32
		Replacing Fuses	33
		Replacing Lights	33
		STORAGE	34
		TROUBLESHOOTING	36
		SPECIFICATIONS	39
		OPTIONAL EQUIPMENT	40
		DEALER SERVICE AND WARRANTY	41
		LIMITED WARRANTY STATEMENT	42

Construction and Standards

All MasterCraft boats are constructed of the highest quality fiberglass materials and resins available. We take pride in producing boats with the highest standards of quality and workmanship. Our commitment to excellence is evident in every part of the production process and continues to the owner with our 10 year limited warranty.

The hull, deck and inner liner are 100% hand-laid with up to 12 layers of fiberglass matting at major stress points. All major hardware is anchored in 1/4" steel inlaid into hull and liner. All fasteners, hardware, handrails, and lifting rings are high-grade stainless steel. All parts running in water are bronze alloy. Every boat is water tested and quality checked at the factory and a permanent record is kept for future reference.

Standard Features

All MasterCraft boats come equipped with many standard features. Skiing features include platforms, mirrors, storage, tow bars, and recreational ski tow. Amenities include drink holders, stereo, color coordinated upholstery, and acoustical insulated motor box; safety features such as passenger handrails, tethered engine stop switches, and rear facing observer seats; performance features such as full instrumentation, and the customized MasterCraft Power V-8 engine.

Certification

As a member of the National Marine Manufacturers Association (NMMA), every MasterCraft boat and trailer meets the rigid specifications for certification. This certification exceeds the federally mandated USCG requirements and is backed by the 600 member NMMA. Inspections are performed by a nationally recognized independent testing organization; inspectors visit the plant twice a year to check all models for conformance.

The inspectors return unannounced during the year to insure continued compliance with certification requirements.

Certification checks are developed by the NMMA engineering staff and the Marine Service Practices Committee to help guard against overpowering, overloading, fire, explosion, sinking and collisions.

All parts used in the construction of MasterCraft boats meet or exceed all USCG and American Boat and Yacht Council (ABYC) standards. Never use automotive or parts of unknown quality. Insist on only genuine MasterCraft replacement parts from your dealer.

Serial Number Locations

NOTE

The removal, tampering, alteration, or obliteration of any or all identification numbers will relieve MasterCraft from all obligations to make warranty repairs or replacements.

Hull - The Hull Identification Number (HIN) can be found at the top, outside, starboard corner of the transom. The HIN is molded into the transom and federal law prohibits removal or tampering in any way.

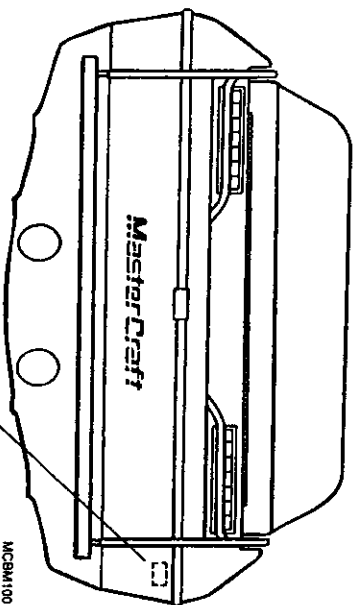

Maristar 240 Open Bow Shown

Engine - The engine identification plate can be found at the rear, inside of the starboard valve cover.

Transmission - The transmission identification plate can be found on the top, port side of the housing.

The identification numbers of your boat are important to you. Record the serial and model numbers of your boat in the spaces provided for future reference. Keep a copy of these numbers on a separate sheet of paper and store in a safe place other than your boat. In case of theft, report these numbers in writing to the local authorities, your insurance agent, and MasterCraft, c/o Customer Service, MasterCraft Boat Co., Rt. 9 Box 152, Maryville, TN 37801.

HULL

Registration Number/State _____

HIN _____

Date Purchased _____

Dealer/Phone _____

Ignition Key Number _____

ENGINE

Model _____

Serial _____

TRANSMISSION

Model _____

Serial _____

SAFETY

Understand that your safety and the safety of others around you is a direct result of how you operate and maintain the boat. Read and understand this manual, and make sure that you understand all controls and operating instructions before attempting to operate the boat. Improper operation is extremely dangerous.

The basic safety rules are outlined in this section of the manual. Additional precautions and this symbol:



WARNING

will appear above hazardous or unsafe practices which **COULD** result in severe personal injury or death.

This symbol:



CAUTION

will appear above hazardous or unsafe practices which **COULD** result in minor personal injury or product or property damage.

The precautions listed in this manual and on the boat are not all-inclusive. If a procedure, method, tool or part is not specifically recommended by MasterCraft, you must satisfy yourself that it is safe for you and others, and that the boat will not be damaged or made unsafe as a result of your decision. REMEMBER - ALWAYS USE COMMON SENSE WHEN OPERATING!

In addition to everyday safety, failure to observe the following safety information may result in severe personal injury or death to you or other persons. Use caution and common sense when operating; don't take unnecessary chances! Be sure this information reaches all operators.

General Precautions

Boating safety starts with a thorough understanding of operation. There are many sources of information available and we at MasterCraft urge you to pursue additional training. The following is a listing of just some of the agencies and organizations that offer safety training or information:

- American Red Cross, National HQ
17th & D Streets NW
Washington, DC 20006
(202) 639-3686
- American Water Ski Association (AWSA)
P.O. Box 191
Winter Haven, FL 33880
(813) 324-4341
- Boat Owners Association of the United States (BOAT/US)
880 South Pickett Street
Alexandria, VA 22304
(703) 823-9550
- National Safe Boating Council
2550 M Street NW, Suite 425
Washington, DC 20037
(202) 296-4588
- U.S. Coast Guard Auxiliary
Commandant (G-NAB)
2100 Second Street SW
Washington, DC 20593-0001
1-800-336-BOAT.

SAFETY EQUIPMENT

BUCKET

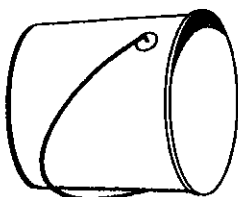

MOORING LINE

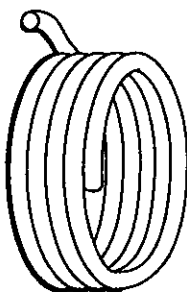

SPARE PARTS

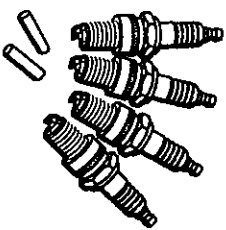

LUBRICANTS

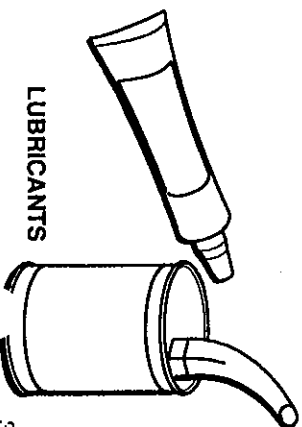

Construction and Standards

All MasterCraft boats are constructed of the highest quality fiberglass materials and resins available. We take pride in producing boats with the highest standards of quality and workmanship. Our commitment to excellence is evident in every part of the production process and continues to the owner with our 10 year limited warranty.

The hull, deck and inner liner are 100% hand-laid with up to 12 layers of fiberglass matting at major stress points. All major hardware is anchored in 1/4" steel inlaid into hull and liner. All fasteners, hardware, handrails, and lifting rings are high-grade stainless steel. All parts running in water are bronze alloy. Every boat is water tested and quality checked at the factory and a permanent record is kept for future reference.

Standard Features

All MasterCraft boats come equipped with many standard features. Sking features include platforms, mirrors, storage, tow bars, and recreational ski tow. Amenities include drink holders, stereo, color coordinated upholstery, and acoustical insulated motor box; safety features such as passenger handrails, tethered engine stop switches, and rear facing observer seats; performance features such as full instrumentation, and the customized MasterCraft Power V-8 engine.

Certification

As a member of the National Marine Manufacturers Association (NMMA), every MasterCraft boat and trailer meets the rigid specifications for certification. This certification exceeds the federally mandated USCG requirements and is backed by the 600 member NMMA. Inspections are performed by a nationally recognized independent testing organization; inspectors visit the plant twice a year to check all models for conformance.

The inspectors return unannounced during the year to insure continued compliance with certification requirements.

Certification checks are developed by the NMMA engineering staff and the Marine Service Practices Committee to help guard against overpowering, overloading, fire, explosion, sinking and collisions.

All parts used in the construction of MasterCraft boats meet or exceed all USCG and American Boat and Yacht Council (ABYC) standards. Never use automotive or parts of unknown quality. Insist on only genuine MasterCraft replacement parts from your dealer.

Serial Number Locations

NOTE

The removal, tampering, alteration, or obliteration of any or all identification numbers will relieve MasterCraft from all obligations to make warranty repairs or replacements.

Hull - The Hull Identification Number (HIN) can be found at the top, outside, starboard corner of the transom. The HIN is molded into the transom and federal law prohibits removal or tampering in any way.

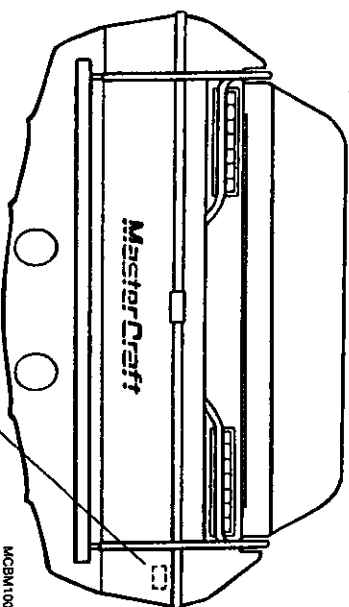

Maristar 240 Open Bow Showra

Engine - The engine identification plate can be found at the rear, inside of the starboard valve cover.

Transmission - The transmission identification plate can be found on the top, port side of the housing.

The identification numbers of your boat are important to you. Record the serial and model numbers of your boat in the spaces provided for future reference. Keep a copy of these numbers on a separate sheet of paper and store in a safe place other than your boat. In case of theft, report these numbers in writing to the local authorities, your insurance agent, and MasterCraft, c/o Customer Service, MasterCraft Boat Co., Rt. 9 Box 152, Maryville, TN 37801.

HULL

Registration Number/State _____

HIN _____

Date Purchased _____

Dealer/Phone _____

Ignition Key Number _____

ENGINE

Model _____

Serial _____

TRANSMISSION

Model _____

Serial _____

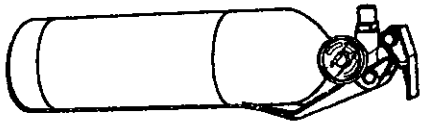

FIRE EXTINGUISHER

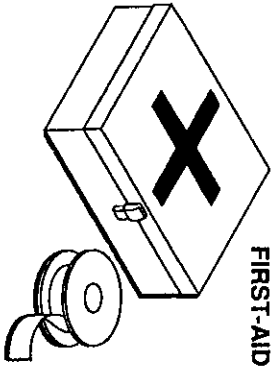

FIRST-AID KIT

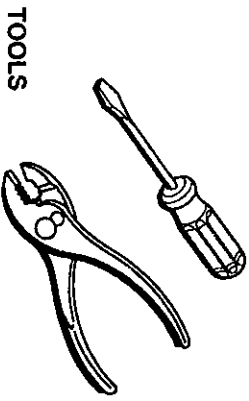

TOOLS

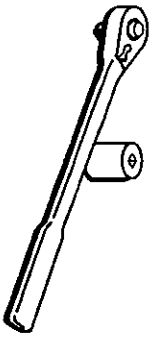

Safety Equipment

Federal law requires certain safety equipment to be on board at all times. In addition, responsible boaters carry other equipment in case of emergency. Check with the local boating authorities for any additional requirements over and above federal requirements.

REQUIRED EQUIPMENT - Your MasterCraft has been equipped at the factory with most federally required (Class 1, 16' to 26') safety equipment for inland waters. This equipment includes:

- U.L. Approved Marine Fire Extinguisher, Type A-BC (2 lbs.) good for solids, liquids, and electrical fires
- ABYC Approved Marine Mufflers with water injection
- USCG Approved Marine Flame Arrestor
- USCG Approved Engine Box Ventilation with sparkless power blower
- ABYC Approved Electric Horn sound warning device
- USCG Approved Inland Lighting

Federal law also requires at least one Type I, II or III Personal Flotation Device (PFD) for each person on board or being towed on water skis; and, in addition, one throwable Type IV PFD. As the owner, obtaining PFD's is your responsibility, your MasterCraft dealer can assist you.

Requirements for coastal waters and inland waters differ, check with the local authorities for more information.

NOTE

RECOMMENDED EQUIPMENT - A good captain will avoid potential problems on an outing by having additional equipment on board. Normally, this equipment is dependent on the body of water and the length of the trip. We suggest the following as a minimum, your MasterCraft dealer can assist you:

- Anchor with at least 75' of line
- Bailing (dewatering) device (scoop, bucket, handpump, etc.)
- Combination oar/boat hook
- Day/night visual distress signal (check local restrictions)
- First aid kit and manual
- Waterproof flashlight
- Local charts
- Mooring lines and fenders
- Extra engine oil
- Tool kit
- Portable AM/FM radio

Safety Afloat

Like most situations, many boating related accidents are caused by the operator's failure to follow basic safety rules or written precautions. Most accidents can be avoided if the operator is completely familiar with the boat, its operation, and can recognize potentially hazardous situations before an accident occurs.

WARNING

Improper operation is extremely dangerous. Operators must read and understand all operating manuals supplied with the boat before operation. Improper operation could result in severe personal injury or death.

WARNING

On board equipment must always conform to the governing federal, state, and local regulations. Nonconformance may be hazardous to you and others around you.

WARNING

Always attach the engine safety shut-off switch lanyard to a part of your clothing such as a belt loop when operating. Failure to do so may cause serious injury or death.

WARNING

Never override or modify the engine safety shut-off switch or engine neutral starting safety switch in any way. Doing so may cause serious injury or death.

WARNING

Never operate the boat while under the influence of alcohol or other drugs. Doing so may cause serious injury or death.

WARNING

Never stand or allow passengers to stand in the boat or sit on the motor box while underway. You or others may be thrown from the boat and seriously injured.

WARNING

Prior to starting the engine, you must open the engine box and check the engine compartment and bilge for gasoline and oil vapors; you must also operate the blower for at least 4 minutes. Failure to do so may result in fire or explosion and may cause serious injury or death.

WARNING

Never remove or modify any components of the fuel or carburetion systems except for maintenance by qualified personnel. Tampering with fuel and carburetion components may cause a hazardous condition which could result in severe personal injury or death.

WARNING

Never allow any type of sparks or open flame on board. It may result in fire or explosion and may cause serious injury or death.

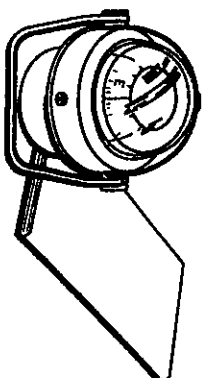

COMPASS, CHARTS & MAPS

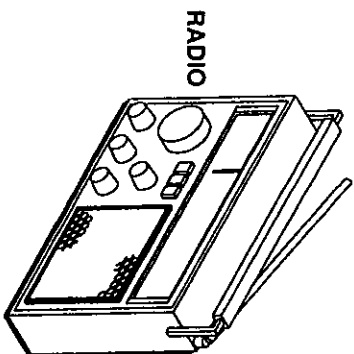

RADIO

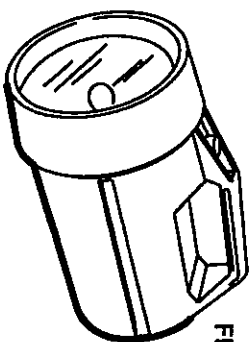

FLASHLIGHT



SPARE BATTERIES

Skating Safety

Skiers, like operators, must be aware of the fundamental safety rules of water skiing. If you are new to the sport, seek certified training before going out for the first time. Join the local ski club and AWSA if possible. Always remember that the majority of water ski injuries are the result of impacts with other objects so always look where you are going and be aware of what is going on around you.

WARNING

The skier(s) must always wear a USCG approved personal flotation device. Failure to do so may cause serious injury or death.

WARNING

Keep at least 100' away from all other objects including other boats, piers, rafts, mooring and navigational bouys, pilings, abutments, etc. Failure to do so may cause serious injury or death.

WARNING

Always have an experienced driver and observer in the boat when skiing. Failure to do so may cause serious injury or death.

WARNING

Never ski in shallow water, close to shore, or in water where you do not know the depth or what is beneath the surface. Doing so may cause serious injury or death.

WARNING

Never put your arm, head, or any other part of your body through the handle-bridle of the ski line or wrap the line around any part of the body at any time. Doing so may cause serious injury or death.

WARNING

Never ski at night, or directly in front of other boats. Doing so may cause serious injury or death.

WARNING

Never jump from a boat that is moving at any speed, or enter or exit the water when the engine is running (ON). Doing so may cause serious injury or death.

WARNING

Make sure that everyone knows and uses approved skiing hand signals and common skiing courtesy. Failure to do so may cause serious injury or death.

Warning Plates and Labels Maristar 240 Open Bow Shown

DANGER!
KEEP AWAY FROM REAR OF BOAT WHILE ENGINE IS RUNNING TO AVOID PERSONAL INJURY.

WARNING!
LIFT RINGS ARE NOT DESIGNED FOR LONG PERIODS OF SUSPENSION.

WARNING
LEAKING FUEL IS A FIRE AND EXPLOSION HAZARD. THE USE OF ALCOHOL MODIFIED FUELS CAN CAUSE DETRIMENTATION OF THE FUEL SYSTEM. INSPECT SYSTEM REGULARLY. EXAMINE FUEL SYSTEM FOR LEAKS OR CORROSION AT LEAST ANNUALLY.

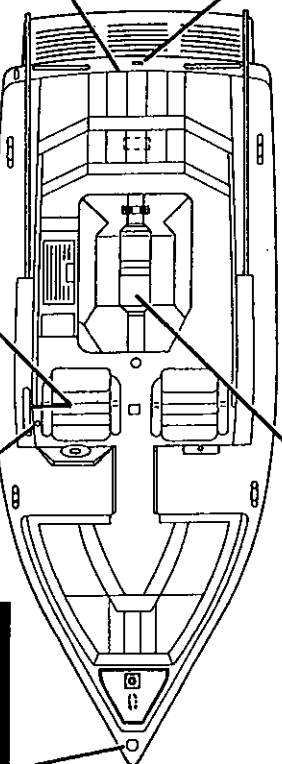

WARNING!
TOW EYE NOT DESIGNED FOR LIFTING RING

DANGER
DO NOT START ENGINE WHILE SOMEONE IS BOARDING BOAT!

BOATMAN'S CHECK LIST

- For maximum enjoyment and safety, check each of these items BEFORE you start your engine:
- ✓ DRAIN PLUG (Securely in place?)
 - ✓ LIFE-SAVING DEVICES (One for every person on board?)
 - ✓ STEERING SYSTEM (Working smoothly and properly?)
 - ✓ FUEL SYSTEM (Adequate fuel? Leaks? Fumes?)
 - ✓ BATTERY (Fully charged? Cable terminals clean and tight?)
 - ✓ CAPACITOR PLATE (Are you overloaded or overpowered?)
 - ✓ WEATHER CONDITIONS (Safe to go out?)
 - ✓ ELECTRICAL EQUIPMENT (Lights, horn, pump, etc.?)
 - ✓ EMERGENCY GEAR (Fire extinguisher, bailer, paddle, anchor & line, signalling device, tool kit, etc.?)

© NADA 1981

MC84101

GENERAL LAY-OUT

MarlStar 240 Open Bow Show

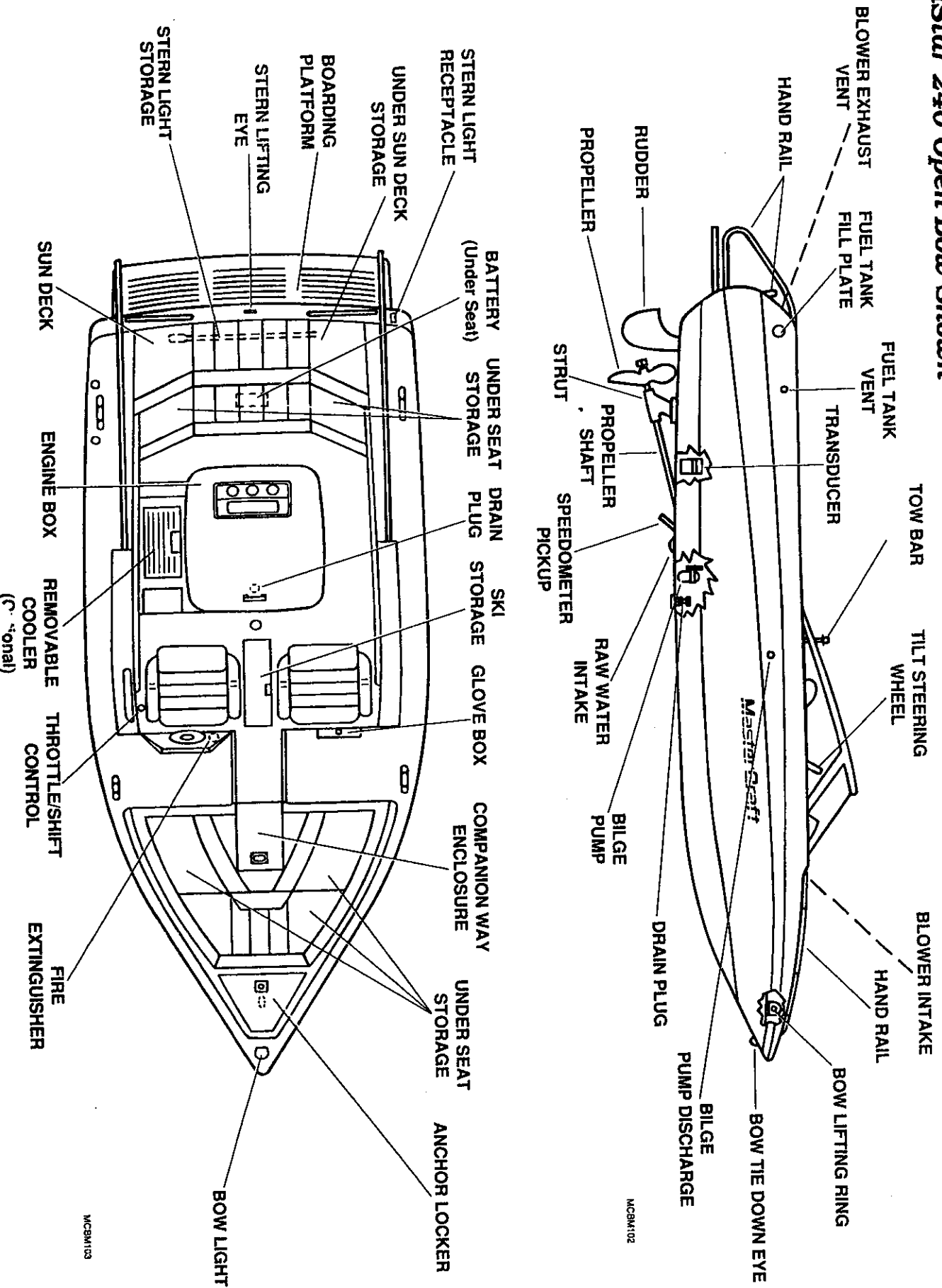

MCRM102

MCRM103

GENERAL LAY-OUT

MarStar 240SC Shown

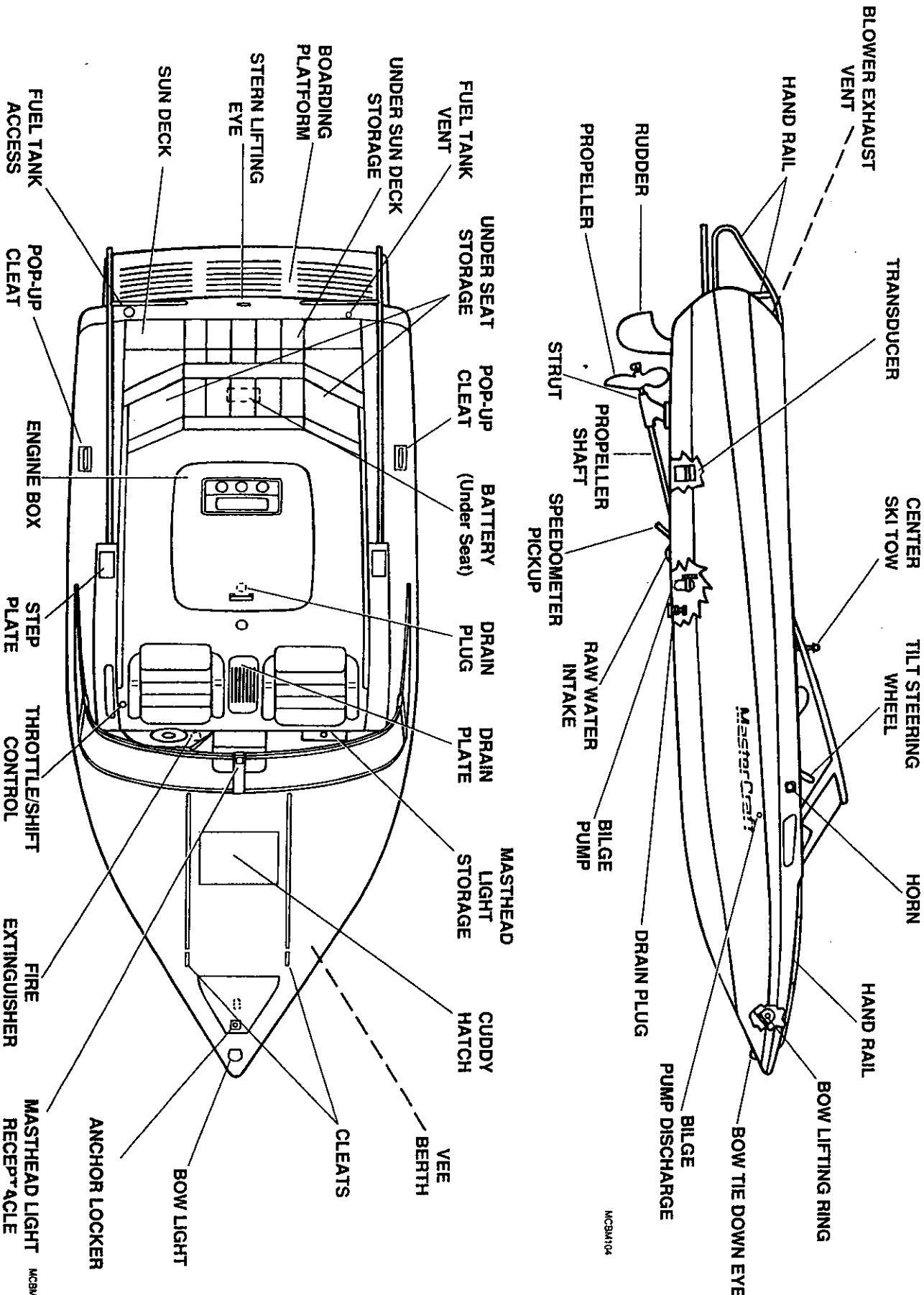

MC240104

MC240105

CONTROLS AND INDICATORS

Gauges

- 1 **Engine Hourmeter** - Registers accumulated engine operating time, and is activated when the ignition switch is in the "ON" position. Be aware that time will be logged whenever the ignition switch is "ON", even when the engine is not running. Use the hourmeter to keep accurate logs for scheduled maintenance.
- 2 **Speedometer** - Indicates forward speed of boat in miles per hour.
- 3 **Tachometer** - Indicates engine speed in crankshaft revolutions per minute (RPM). Propeller shaft RPM is the same as the engine except for boats equipped with the Power Slot package in which case propeller shaft RPM is one to one and one-half of the engine RPM.
- 4 **Voltmeter** - Indicates electrical system operating voltage in volts DC. Normal operating voltage is between 14.7 and 15.5 volts.
- 5 **Fuel Gauge** - Indicates the approximate amount of fuel in fuel tank in quarters of a tank (approx. 13.25 gal. on the Open Bow and 11 gal. on the 240SC). Readings are only approximate and should be compared to the hours of operation multiplied by the known fuel consumption (GPH). The gauge is activated with the ignition switch.
- 6 **Engine Temperature Gauge** - Indicates the cooling water/coolant inside the engines in °F. Normal operating temperature is between 170°F and 195°F.
- 7 **Engine Oil Pressure Gauge** - Indicates the pressure of the lubricating oil inside the engine in PSI. Normal pressure is between 10 to 30 PSI at idle.

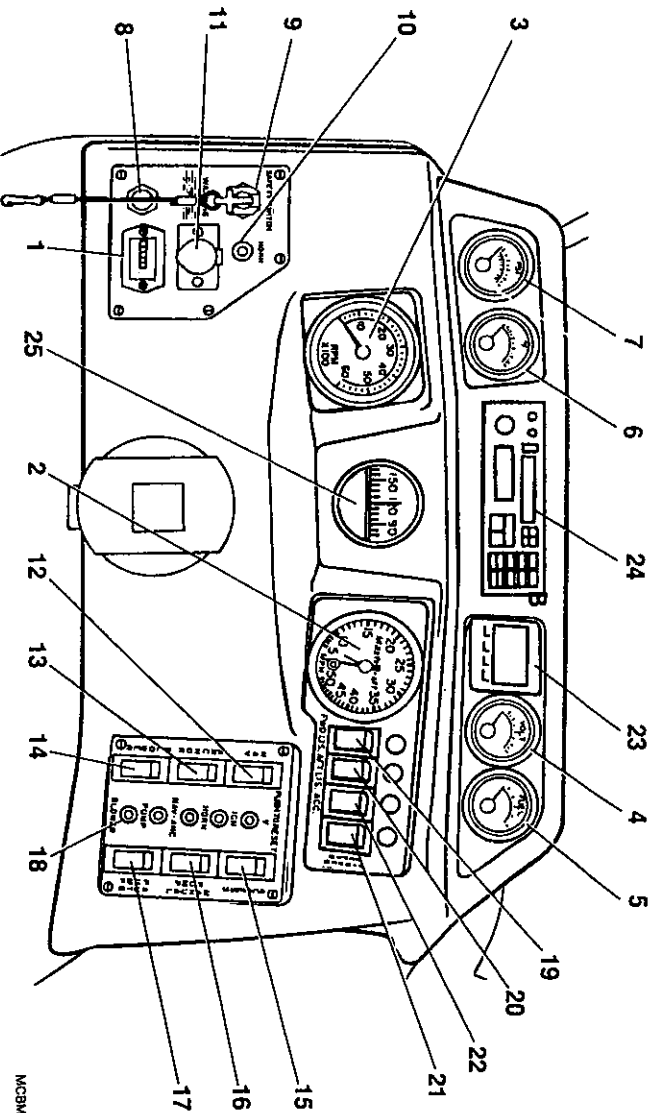

Maristar Dashboard

MCBM106

Switches

- 8 **Ignition Switch** - The ignition switch has four positions: accessory, off, run (ignition), and start. Never leave the switch in the RUN position without the engine running; doing this will prevent natural discharge of the battery. It is also used to activate the fuel gauge.
 - 9 **Safety Switch** - The emergency engine safety switch is an ignition cutoff switch designed to stop the engine in the event of an operator being thrown from position or moving too far from the helm. The lanyard is equipped with a hook on one end for attachment to your clothing and on opposite end that attaches to the switch. Be sure that the lanyard is firmly attached to the switch before starting.
 - 10 **Horn Switch** - Activates the electric horn. Push and hold to sound horn.
 - 11 **Accessory Outlet** - Provides power to run accessory electrical equipment. Power is available even with the ignition switch off.
- WARNING**
- The safety switch lanyard must be attached to the operator whenever the engine is started. Failure to do so may cause serious injury or death.

12 Navigation/Instrument Lights - A two position rocker switch that activates the instrumentation lighting as well as both the bow (red/green) and stern (white) lights for night running. Push the top half of the switch to turn lights ON; an orange indicator in the center of the switch will glow.

13 Anchor Light - A two position rocker switch that activates only the masthead (white) light when anchored at night. Push the top half of the switch to turn light ON; an orange indicator in the center of the switch will glow.

14 Blower Switch - A two position rocker switch that activates the engine box ventilation blower. Push the top half of the switch to turn blower ON; an orange indicator in the center of the switch will glow. **The blower must be operated for a minimum of four minutes before starting the engine at any time. The blower must also be operated during idle and slow speed running.**

15 Accessory Switch - A two position rocker switch that activates the optional heater, this switch operates the heater fan motor. Push the top half of the switch to turn accessory ON; an orange indicator in the center of the switch will glow.

16 Manual Bilge Pump Switch - A two position rocker switch that activates the bilge pump. Push the top half of the switch to turn bilge pump ON; an orange indicator in the center of the switch will glow.

17 Automatic Bilge Pump Switch - A two position rocker switch that arms the bilge pump for automatic operation while underway. Push the top half of the switch to arm bilge pump; an orange indicator in the center of the switch will glow.

18 All major boat circuits, except stereo and accessory (heater option) circuits are protected from shorting and overload by resettable circuit breakers. If a problem develops with

BOAT CIRCUIT	BREAKER NAME	LOCATION	RATING
Engine	Engine Main	Rear of Engine	35 AMP
Ignition and Safety Circuits	IGN	Dashboard	20 AMP
Warning Horn	HORN	Dashboard	10 AMP
Lighting and Fuel Gauge	NAV-ANC	Dashboard	7 AMP
Bilge Pump	PUMP	Dashboard	5 AMP
Ventilation Blower	BLOWER	Dashboard	7 AMP
Accessory Circuit	-----	Behind Dashboard	10 AMP (fuse)
Stereo	-----	Behind Dashboard	3 & 5 AMP (fuse)
Depth Finder	-----	Dashboard	2 AMP
Amplifier	-----	Rear of Amplifier	15 AMP

one of the following circuits, switch OFF the circuit, wait about one minute, push the appropriate breaker button fully, and switch ON the circuit. If the circuit continues to trip, there is a problem somewhere that must be attended to immediately. See your MasterCraft dealer.

Controls

19 Forward Interior Lighting - A two position rocker switch that activates courtesy lights in the Open Bow walk thru deck and provides current to the cuddy light switches on the 240SC. Push the top half of the switch to turn the light ON; an orange indicator in the center of the switch will glow.

20 Aft Interior Lighting - A two position rocker switch that activates courtesy lights in the side storage and below the sun deck on the Open Bow, and activates courtesy lights in the footwells and cockpit side panels on the 240SC. Push the top half of the switch to turn light ON; an orange indicator in the center of the switch will glow.

21 Accessory Switch - A two position rocker switch that activates the depth finder. Push the top half of the switch to turn ON; an orange indicator in the center of the switch will glow.

22 Accessory Switch - A two position rocker switch that activates an owner installed accessory. Push the top half of the switch to turn accessory ON; an orange indicator in the center of the switch will glow.

23 Depth Finder - Measures water depth from boat bottom to lake bottom by using an ultrasonic signal. Can be used at any speed. See operations manual.

24 AM-FM Cassette Stereo - See instruction manual.

25 Compass - Indicates direction of travel.

26 Steering Wheel - The steering wheel is mechanically linked to the rudder by a push-pull cable. The tilt positions are controlled by a lever on the bottom of the wheel hub.

Circuit Breakers

27 Shift/Throttle Control - This one-hand, single lever control operates as both a gear shifter and a throttle. The lever automatically locks in the neutral (straight up and down) position for safety. The lever can only be moved from neutral by raising the lifter "A" under the ball knob. Shifting is accomplished by moving the lever into the first 45° of travel; push the lever for forward, and pull the lever back for reverse. By advancing the lever beyond 45°, you move from the shifting range to the throttle range. Never attempt to shift without the engine running. The shift mechanism of this control can be disengaged with button "B" for setting the automatic choke, thereby allowing easier starting and engine warm-up.

FUELING

The ignition timing as set by the factory requires the use of leaded or unleaded fuel with a minimum Research Octane Number (RON) of 93 or a minimum Anti-Knock Index Number (AKI) /Pump Octane Number of 89 octane. Most any high quality gasoline available for automotive use may be used without difficulty.

⚠ CAUTION

Damage to the engine by use of low quality gasoline or gasoline with an octane rating below the minimum level listed below will void the warranty.

If fuels with 93 RON (89 AKI/Pump) octane are not available in your area, the ignition timing must be retarded so that low octane fuels, with a minimum of 90 RON (86 AKI/Pump) octane can be used; see your MasterCraft dealer. When the ignition timing is retarded, a decrease in engine power can be expected.

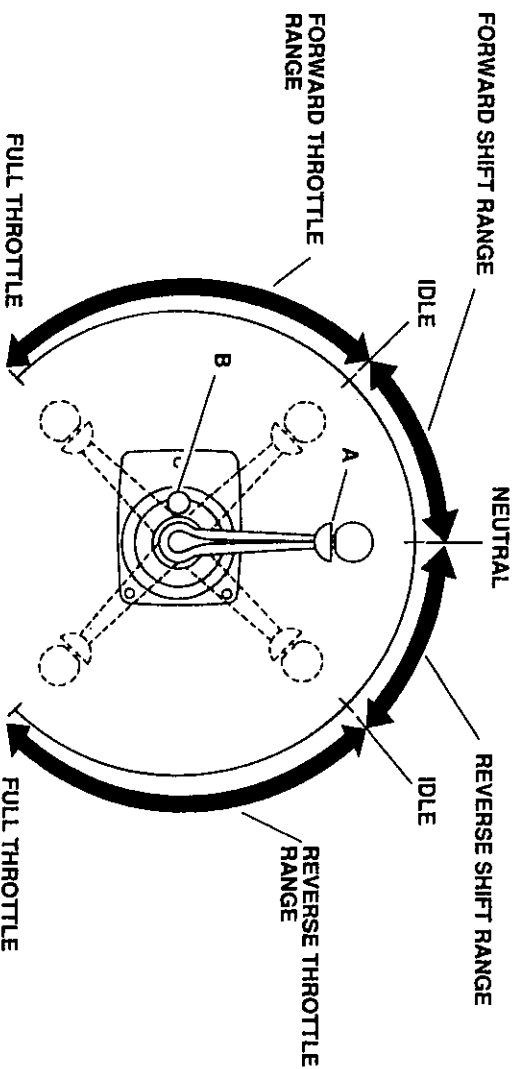

We do not recommend that you use low quality alcohol modified fuels in your MasterCraft because of the following side effects:

- **Moisture** - Alcohol blended fuels absorb and keep moisture. Moisture inside the fuel tank can cause many engine problems. Fuel tank inspection and cleaning must be done more often.
 - **Performance** - Alcohol blended fuels cause the engine to operate on a leaner fuel/air ratio and may cause hard starting, stalling and vapor lock. Engine damage may result.
 - **Deterioration** - Alcohol quickly deteriorates rubber and plastic components in the fuel system causing more frequent inspection and replacement of parts. This increases the potential for fire and explosion due to fuel leakage.
- Fuel additives and treatments, other than conditioners for moisture absorption and winter storage, are not recommended for use in MasterCraft Power engines.

⚠ WARNING

Gasoline is extremely flammable and highly explosive under certain conditions. Always stop the engine and never smoke or allow open flames or sparks within 50 feet of the fueling area when refueling.

Take care not to spill gasoline. If gasoline is spilled accidentally, wipe up all traces of it with dry rags and dispose of the rags properly onshore immediately.

Always tighten the fuel plate cap completely with the cap key after refueling.

If your MasterCraft will not be in use for a period of 60 days or more, it is important to drain the engine of fuel prior to the storage period. Failure to do so can allow fuel in the carburetor to turn to varnish resulting in possible engine damage. See Storage, page 34.

MCSM108

KNOTS



FIGURE EIGHT

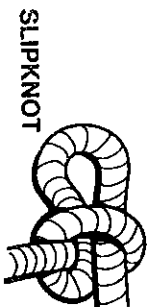

SLIPKNOT

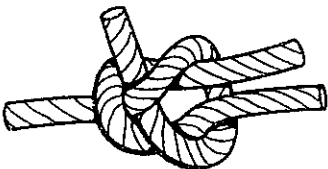

SHEET BEND



BOWLINE

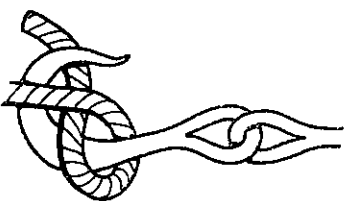

BLACKWALL HITCH

LAUNCHING/LOADING

Preparing to Launch

Before backing down to the ramp, perform the following on level ground:

1. Remove the boat cover, if equipped.
2. Perform daily **Before Each Operation** safety and maintenance checks and services, page 14.
3. Load and stow any additional equipment if necessary.
4. Check that bilge drain plug is in place.
5. Remove any additional trailering tie-downs from the boat.
6. Attach the bow and stern docking lines and fenders if necessary.
7. Disconnect the trailer lights from the car.

Launching

Launching is normally accomplished with two people although it is possible for a single person to launch but takes more time and ties-up the ramp. Since all launches are different from each other in some way, the following must be modified to fit the launch in use:

1. Back the boat down the ramp until the wheels are at least halfway submerged. Keep the trailer/car combination as straight as possible, and, if possible, perpendicular to the shore line.
2. Set the Boat Buddy Lock System to the locked open position. Slide the lever over to the port side, and then rotate the lever forward into the upper notch. (Tightening of winch may be required to release pressure off pin.)

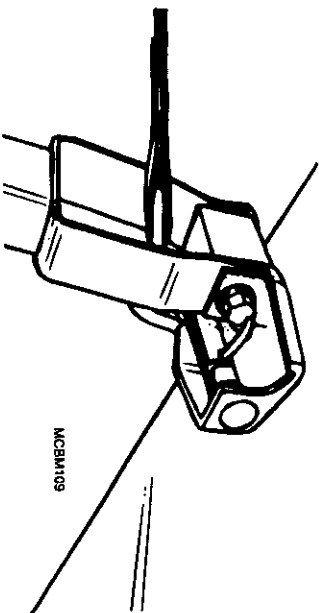

MCBMT09

Boat Buddy Lock System
Locked - Open Position

3. Loosen and detach the bow strap from the bow eye.
4. Back the boat further down until the top of the fenders are about 2" above the water.



If you are launching by yourself, place the car in "Park", securely set the parking brake, and turn the engine "OFF".

5. Board the boat and start it. If possible, remain on the trailer until the engine has warmed-up.
6. Back the boat slowly, straight off the trailer.

Loading

Loading, like launching, is best done with two people:

1. Back the trailer into the water until the top of the fenders are about 3" above the water. Keep the trailer/car combination as straight as possible and, if possible, perpendicular to the shoreline. Set the parking brake securely.
2. Set the Boat Buddy Lock System to the set position. Slide the lever over to the port side, and then rotate the lever shaft slightly into the lower notch.

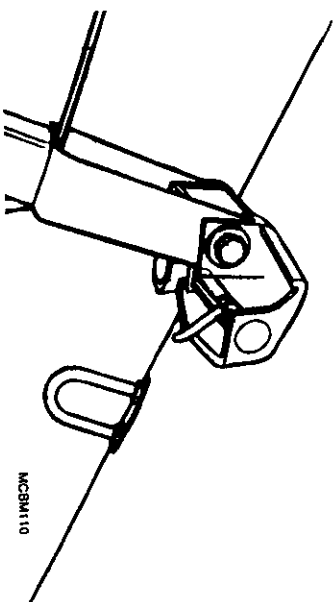

MCBMT10

Boat Buddy Lock System
Set Position

- Approach the trailer in a straight line from at least 50' out. Use "bursts" of propeller thrust to move towards the trailer at the slowest steerable speed. Guide the boat between the alignment posts and onto the carpeted support bunks.
- Check to see that the boat is centered on the support rails and is headed in a straight line for the bow stop (bumper board).

CAUTION

Excessive throttle can cause the boat to travel over the bow stop (bumper board) causing extensive damage to the boat, trailer and car.

- Using a very light touch on the throttle, ease the boat forward until the bow comes to rest against the bow stop (bumper board).
- Ease the boat forward until the Boat Buddy system latches on the bow eye, causing the lever to move into the closed position.

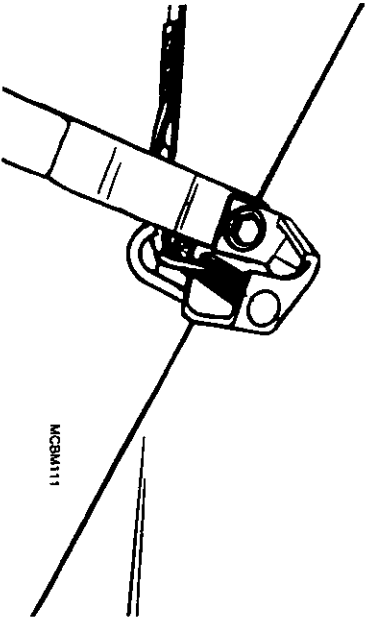

**Boat Buddy Lock System
Closed Position**

CAUTION

The winch bow strap is merely a means of securing the boat to the trailer and is not intended to winch or pull the boat onto the trailer.

- Engage the safety retaining pin and attach and tighten the winch bow strap.
- Pull the trailer up the ramp and attach any additional tie-downs and connect the trailer light harness.
- Unload any extra gear if necessary.
- Perform the **After Operation** safety and maintenance checks and services, page 14.

CAUTION

Do not trailer the boat with the boat cover installed. Wind "whipping" the cover will cause chafing and other damage.

GRANNY KNOT

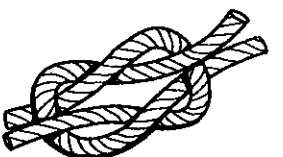

OVERHAND



SHEEPSHANK

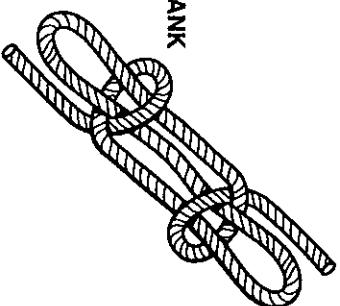

SQUARE KNOT

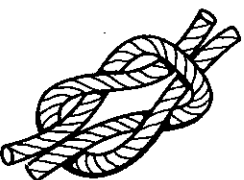

CLOVE HITCH



CARRICK BEND



DISTRESS SIGNALS

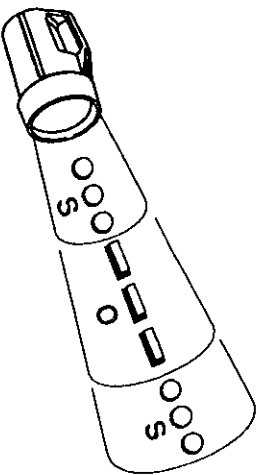

ELECTRIC DISTRESS LIGHT

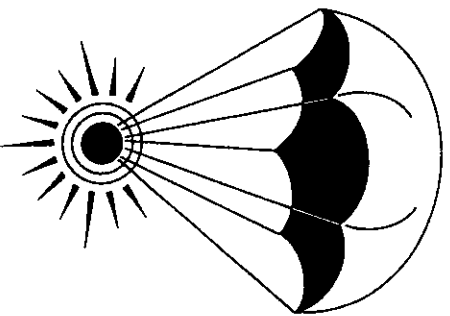

RED PARACHUTE FLARE



RED METEOR FLARE

SAFETY CHECKS AND SERVICES

The following checks and services are essential to safe boating and must be performed. Get in the habit of performing these checks in the same order each time so that it becomes routine.

⚠ WARNING

DO NOT launch the boat if any problem is found during the Safety Check. A problem could lead to an accident during the outing causing severe injury or death. Have any problem attended to immediately; see your MasterCraft dealer.

Before Each Operation

- Check that there is an adequate supply of fuel.
- Check that the steering system operates properly.
- Check that the required safety equipment is on board.
- Check that the fire extinguisher is fully charged.
- Check the weather report, wind and water conditions.*
- Check for recommended on board tools and parts.*
- Check that no fuel, oil or water is leaking or has leaked into the bilge compartment.

NEW BOAT BREAK-IN

NOTE

Failure to follow the break-in procedure exactly as stated will void the engine warranty.

The first 20 hours of operation are the most important to your boat. Proper break-in will ensure maximum performance and longest powertrain life. The break-in period allows moving parts within the engine and transmission to “wear-in” to one another and acts as the final “tug of parts. All MasterCraft

- Check all hoses and connections for leakage and damage.
- Check that bilge drain plug is installed properly.*
- Check the propeller and shaft for damage.*
- Check the cooling water intake pick-up for blockage.*
- Check that all required **Scheduled Maintenance Checks and Services** have been performed.

During Operation

- Check gauges frequently for signs of abnormal behavior.
- Check that controls operate smoothly.
- Check for excessive vibration.

After Operation

- Fill fuel tank to prevent moisture due to condensation.
- Check for fuel, oil and water leakage.
- Check the propeller and shaft for damage.*
- * Best accomplished with boat out of water.

boats are operated for a short period of time on the water before leaving the factory, but break-in must continue for the 20 hour period.

⚠ CAUTION

To ensure proper break-in and lubrication, do not remove factory break-in oil until after the initial 10 hours of operation.

NOTE

Before operating the boat for the first time you must read this manual completely.

Please follow the break-in procedure carefully; close attention to the following is very important:

- **Maintain proper oil level.** Until the piston rings, cylinders, etc. are thoroughly seated, oil consumption can be high and must be carefully watched.
- **Pay close attention to gauges.** It is important to stop the engine immediately if the gauges indicate a problem. Low oil pressure and overheating are serious and require immediate attention.
- **Abnormal vibration/noises.** A sure sign of impending trouble, vibration and noises can usually be traced to loose mountings, hardware or driveline damage.
- **Fuel, oil or water leaks.** While not as damaging to engine operation, leaks pose a serious safety threat and are most likely to occur after a few hours of operation.
- **Vary the engine speed.** Never run the engine for more than three minutes at any constant RPM during the break-in period. Doing this will assist in the proper break-in of rings and bearings.
- **Plane the boat quickly.** Operating the boat at low (before planing) speeds places an excessive load on the engine. Plane quickly, then back down to a slower planing speed.

The First Hour of Operation

1. Start the engine and allow to warm-up to normal operating temperature (170° F) at low idle (600 - 800 RPM).

2. Operate the boat in neutral for 5 - 10 minutes at high idle (800 - 1200 RPM). This will ensure proper lubrication.

3. Operate the boat in forward gear, accelerate quickly, but gradually to planing speed and bring the throttle back to maintain a planing attitude. Vary the engine speed, but **do not exceed 2000 RPM** for the first hour.

The Next Four Hours

Continue operation at plane, vary the engine speed but **do not exceed 3000 RPM**. Occasionally reduce throttle to idle speed for a cool-down period.

The Next Five Hours

1. Continue operation at plane, vary the engine speed but **do not exceed 4000 RPM**. Occasionally reduce throttle to idle speed for a cool-down period.
2. Return the boat to your MasterCraft dealer for the 10 hour inspection. At this time he will change the engine oil and filter and make other necessary checks, adjustments and services.

The Final Ten Hours

Operation during the final ten hours of break-in is very much the same as the second five hours except that it is permissible to run at full speed for 2 - 3 minutes at a time. Do not accelerate suddenly from low to full speed; increase speed gradually. Again, an occasional cool-down period is helpful.

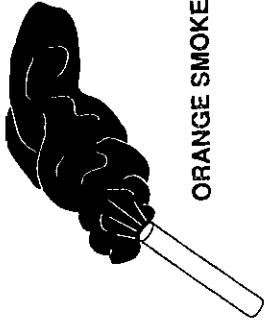

ORANGE SMOKE SIGNAL

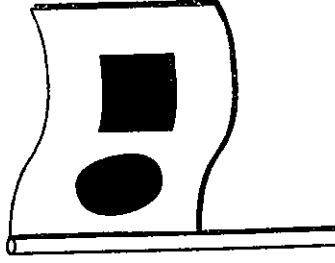

ORANGE FLAG



ORANGE SMOKE SIGNAL
(Floating)

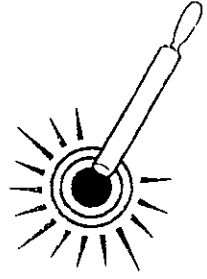

RED DISTRESS FLARE

WATERWAY MARKERS



SPHERICAL



CAN

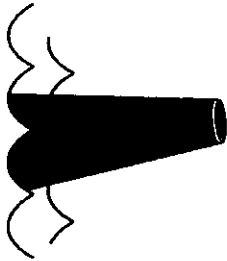

SPAR

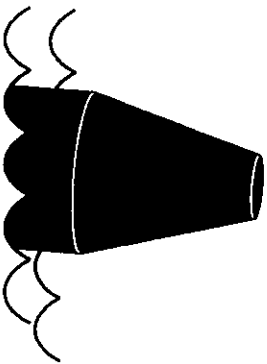

NUJN

After Break-In

Once the break-in period is over, the boat may be operated continuously at any speed, but not beyond the maximum speed of 4600 RPM.

Always remember that during normal operation, allow the engine to warm-up gradually, be sure the engine is warm before accelerating, and pay careful attention to the gauges and engine safety warning

STARTING AND BASIC OPERATION

Before Starting

NOTE

If operating for the first time, you must follow the New Boat Break-In procedures as described on page 14. Failure to follow these procedures could result in serious engine damage and will void the warranty.

Familiarize yourself with the controls and indicators used on your MasterCraft.

Perform all **Safety Checks and Services** as described on page 14.

Perform all **Scheduled Maintenance Checks and Services** as described on page 23.

1. Operate the bilge blower for at least 4 minutes. Leave the bilge blower ON until the boat has planed.



WARNING

To prevent a possible explosion, operate the blower for at least 4 minutes before starting the engine and always when at idle and slow speed running. Explosive gasoline and/or battery fumes may be present in the engine compartment. Failure to do so may cause serious injury or death.

horn. Also, check the oil level frequently during the first 50 hours of operation since the piston rings and cylinders take that long to seat properly.

After the initial 50 hours of operation, the engine oil and filter must be changed. This second oil change is very important to long engine life. After break-in, all maintenance is performed at regular intervals, see **Scheduled Maintenance Checks and Services**, page 23.

2. Open the engine compartment and check the fuel sight tube for traces of fuel or anything else adhering to the inside of the tube. If any traces are found, do not start the engine, see your MasterCraft dealer immediately!

FUEL SIGHT TUBE

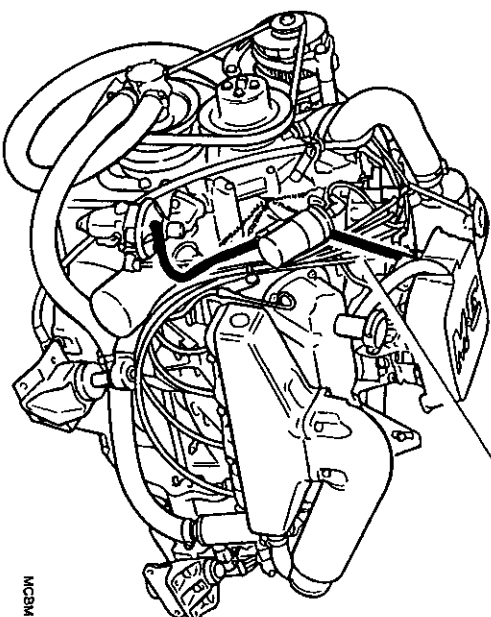

MC98M111

Ford 351 With Fresh Water Cooling System

3. Check the bilge compartment for fuel, oil or water leakage, and for fumes.

Starting the Engine

NOTE

Always start the engine with the control lever in the neutral position or with the shift disengaged. Your boat is equipped with a neutral start safety switch which will not allow the engine to be started in gear.

1. Attach the Emergency Engine Safety Switch tether between an article of your clothing and the switch.

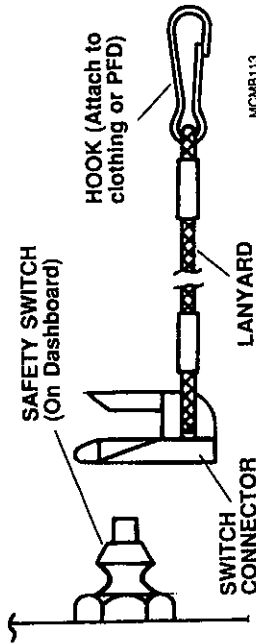

2. Prime the engine as follows (not required when engine is warm):

- a. Pull out the throttle button about 1/4".
- b. Move the throttle lever to the full throttle position once to prime.
- c. Move the throttle back to the idle position.

CAUTION

Do not operate the starter motor continuously for more than 15 seconds without at least a 2 minute "cool-down" period. Failure to do so may cause the starter to overheat and cause damage. Failure to release the ignition key after the engine has started may damage the starter motor and drive.

3. Turn the key switch to the start position and hold until engine starts. Re-prime if necessary. Release key as soon as the engine starts.

NOTE

If the engine should flood, move the lever to the neutral position and then advance the throttle to the full open position, start the engine, and immediately adjust the throttle so that engine speed remains below 1500 RPM.

4. Adjust engine speed to high idle between 800 and 1200 RPM and allow the engine to warm-up for about 2 - 3 minutes. (Not required when engine is warm.)

NOTE

While the engine is warming-up, check to see that all lights and gauges operate properly, that the steering operates properly and that there are no apparent leaks under pressure. Re-engage the control lever after warm-up by returning the lever to neutral and pushing the throttle button back into the engage position.

Shifting Gears

CAUTION

When shifting, always move the control lever smoothly and quickly into gear, do not hesitate. Slow gear engagement could damage the shifting mechanism in the transmission. Always allow the engine speed to fall to low idle (600 - 800 RPM) before making a shift or gear damage may result.

Forward - Raise the lifter ball under the lever knob and briskly push control lever forward into the first 45° of travel. Throttle movement will begin after 45°.

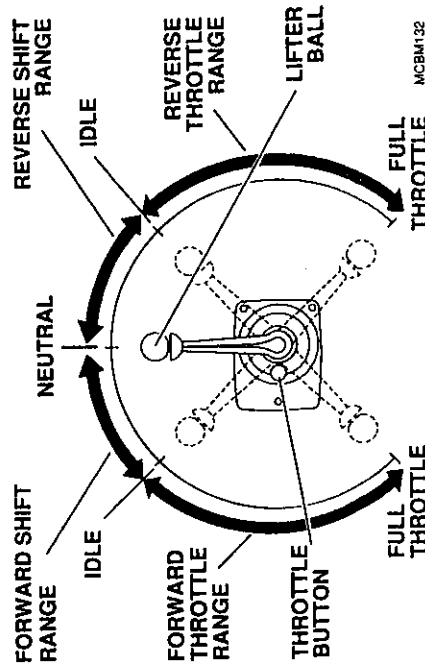

Reverse - Raise the lifter ball under the lever knob and briskly pull the control lever back into the first 45° of travel. Throttle movement will begin after 45°.

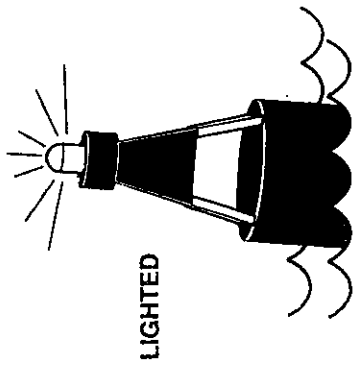

LIGHTED



DAY MARKERS



DAY MARKERS

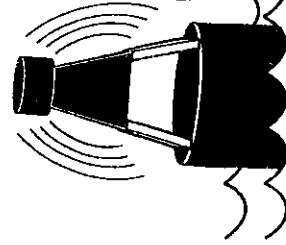

UNLIGHTED BELL

PERSONAL FLOTATION DEVICES (PFD'S)

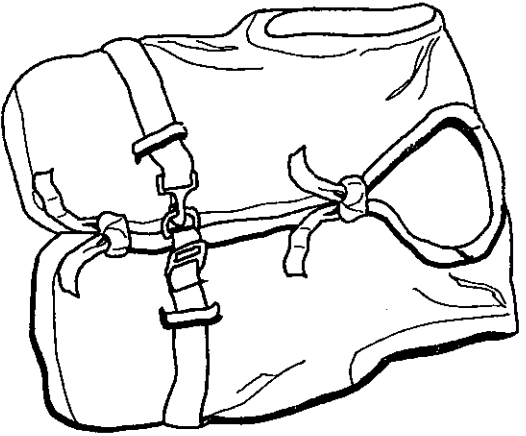

TYPE I
LIFE PRESERVERS

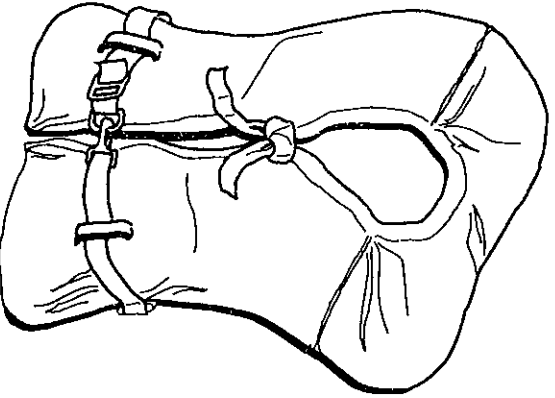

TYPE II
BOUYANT VESTS

Once the shift has been completed, continue to move the control lever slowly in the desired direction to increase speed.

Engine Warning Alarm

Your boat is equipped with a warning alarm under the dashboard which will sound in the event that the engine overheats. If the warning alarm should sound while the engine is running, throttle back to idle speed and shift to neutral IMMEDIATELY, quickly observe the gauges, and STOP the engine IMMEDIATELY.

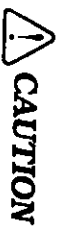

CAUTION

Continued operation after the warning alarm has sounded may cause severe engine damage and will void the warranty.

OPERATIONAL HINTS

General

We at MasterCraft urge you and all others operating the boat to seek certified instruction from the local boating authorities.

This section is designed to present the most basic operational principles. It is NOT intended to cover all conditions encountered during operation. Therefore, the principles presented in this manual are limited to the facts related directly to the operation of the boat, while the responsibility for the proper application of these principles belongs to you.

Loading - NEVER OVERLOAD YOUR BOAT. The Maximum Weight Capacity as listed on the certification plate includes all items added to the boat (persons and gear). Also, proper distribution of weight is critical to boat performance. Distribute the load as evenly as possible.

If the pressure gauge indicates low or no oil pressure, check the oil level. If the temperature gauge indicates overheating, check the raw water pick for blockage. DO NOT operate the boat until the cause for the warning alarm has been found and corrected.

Stopping

1. Slowly bring the control lever to the neutral position. If the boat has been driven for a long period of time at high speed, allow the engine a 2-3 minute cool-down period at low idle (600 - 800 RPM).
2. Turn the ignition key to the OFF position to stop the engine.
3. If any problems were encountered during the outing, have the boat inspected by your MasterCraft dealer and request any necessary repair before the next outing.

MAXIMUM CAPACITIES
12 PERSONS OR 1700 LBS.
1700 POUNDS, PERSONS, GEAR
THIS BOAT COMPLIES WITH U.S. COAST GUARD SAFETY STANDARDS IN EFFECT ON THE DATE OF CERTIFICATION
MANUFACTURER: MASTERCRAFT BOAT COMPANY
3008 HARRIS LANE 240 HENRYVILLE TN
DESIGN COMPLIANCE WITH NADA REQUIREMENTS BELOWS VERIFIED. GEAR RESPONSIBLE FOR PRODUCTION CONTROL
LORD CAPACITY * COMPARTMENT VENTILATION STEERING, FUEL AND ELECTRICAL SYSTEMS INTERNATIONAL LIGHTS * BASIC FLOTATION
NATIONAL MARINE MANUFACTURERS ASSN.

Emergencies - Know how to use and spot distress signals and offer assistance if possible. Remember, you may need assistance some day.

Courtesy - Always respect the rights of others on water. Keep wide when passing, slow down in crowded areas, be alert, and be aware of your wake and wash.

First Time Operation

When taking to the water for the first time, you must keep in mind a few general guidelines.

- **Practice Makes Perfect!** Start in calm water with no wind or current and plenty of room until you get the feel for the boat and its controls.
- **Proceed Slowly!** Give yourself time to think, react, maneuver.
- **Recognize Outside Forces!** Check the wind direction and velocity, as well as water currents and waves.
- **Have A Crew on Hand!** Hands ready with fenders, lines and boat hook can assist you when docking and launching/loading.
- **A Boat Is Not An Automobile!** Boats cannot be maneuvered and stopped like a car. Boats steer from the stern and have no brakes.

Basic Maneuvering

Steering response is dependent on three factors: rudder position, motion and throttle. While high speed maneuvering is relatively easy and takes little practice, slow speed maneuvering is far more difficult and requires much time and practice to master. With both propulsion and steering at the rear of the boat, the initiation of a turn **pushes** the **stern** of the boat **away** from the direction of the turn. The bow follows a smaller turning circle than the stern. This is especially important to remember when making close quarters maneuvers.

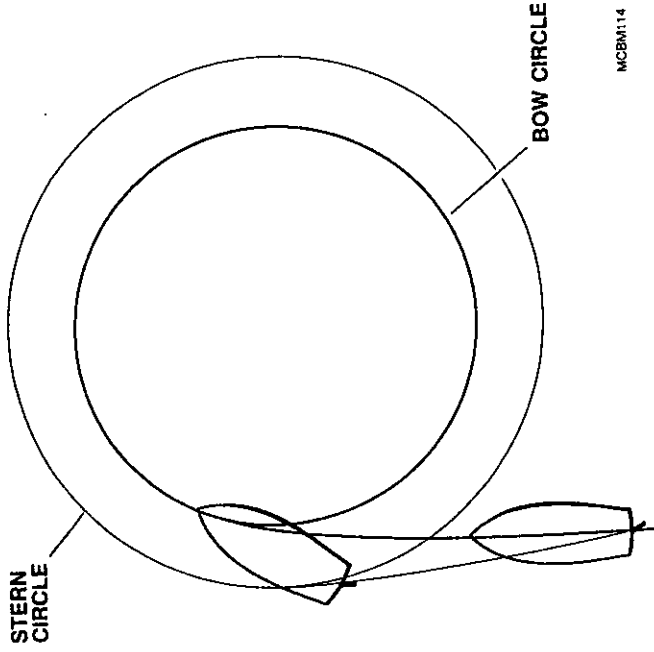

MCBM114

The effects of unequal propeller thrust (torque steering), wind, and current must also be kept in mind. While wind and current may not always be present, a practiced driver will use them to his advantage. Unequal thrust is a phenomenon shared by all single engine propeller driven boats. A counterclockwise rotation propeller tends to cause the boat to drift to the starboard when going forward, and to the port when going backwards with the rudder in the straight ahead position. At high speed this effect is compensated for and is nearly nonexistent, but at slow speed, and especially during backing, the effect can be most powerful. This is the main reason most experienced drivers approach with the dock to the starboard side of the boat.

Stopping or checking headway is a technique that must be mastered. With no brakes, reverse thrust must be used to stop the boat. The momentum of the boat will vary according to the load. Make it a practice to slow to no wake speed before shifting into reverse.

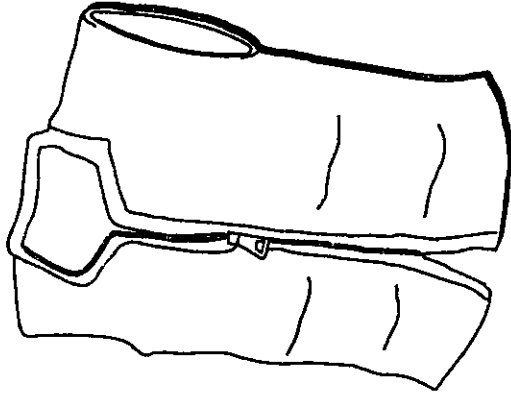

TYPE III
FLOTATION AIDS

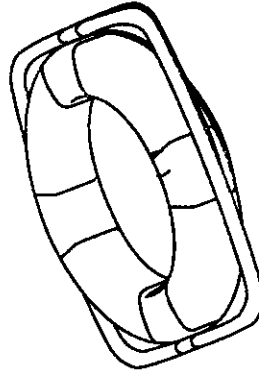

TYPE IV
THROWABLE DEVICES

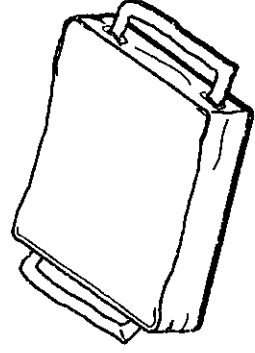

WATER SKIING SIGNALS

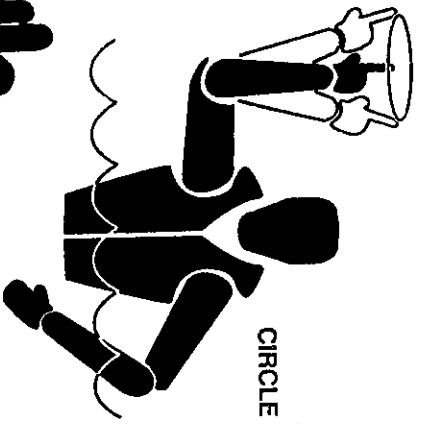

CIRCLE



SPEED O.K.

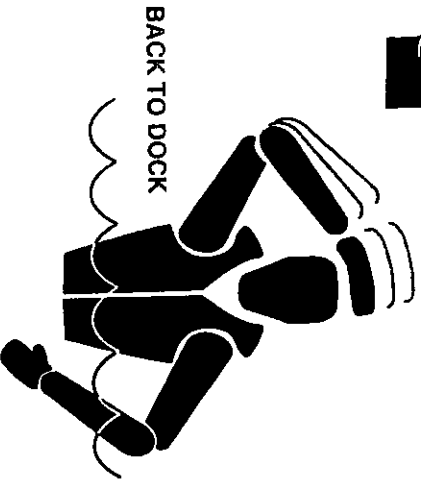

BACK TO DOCK



TURN LEFT



TURN RIGHT

When practicing maneuvering techniques, always do so in open water that is free of traffic: adequate practice may make the difference between a pleasurable or damaging (at least embarrassing) experience.

High Speed Operation

Your MasterCraft was designed to be a pleasure/ski boat. You may have seen professional drivers with advanced operating skills perform high speed maneuvers and "on-a-dime" turns. **DO NOT attempt maneuvers like these.** Paid, professional drivers log thousands of hours on the water and carefully choreograph every move; plans are made in advance if for some reason the routine must be aborted.

Water Ski Towing - Make sure the ski gear is in good condition. Know and use the approved hand signals. Stretch-out before skiing. Always have a competent observer. Use the stern ski tow. Pick a point on shore and drive in a straight line for that point if possible. Never "crack-the-whip" or intentionally cause the skier to fall. Make sure the engine is OFF whenever the skier enters or exits the water. Don't ski until exhausted. Try to find "good" water.

Unusual Operating Conditions

If the body of water is unknown, talk to the local boaters about what obstacles are beneath the water's surface. Rocks, tree stumps, sandbars, and wing dams are both dangerous and damaging. Be especially wary of rivers and man-made lakes, rapidly changing conditions can cause daily changes in underwater hazards. Stay well clear of floating debris; what looks to be a small branch in the water usually turns out to be a tree.

When travelling through weedy areas, keep an eye on the engine temperature gauge; weeds caught-up and blocking water flow through the raw water intake will cause trouble. Also, after leaving the weedy area, shift to neutral for a few seconds and then reverse for a few seconds to "unwind" any weeds that may have wrapped around the propeller.

Docking and Tie-Up - Approach docks slowly with the starboard side of the boat to the dock if possible. The natural tendency to "torque steer" with the rotation of the propeller at slow speeds makes docking easier on that side. Also, use wind and current to your advantage when docking.

Before tying-up the boat, be sure to use enough fenders to protect the boat from damage. If possible, tie-up with the bow towards the waves. Use good quality double-braided nylon line. Tie-up only to the lifting or tie-down eyes, never use the handrails or ski pylon. If the boat is to be moored for a long period of time, use chafing protectors to protect the gelcoat finish. Leave a little slack in the lines, allow for some wave movement or tidal action if applicable.

If the boat is to be kept in or near the water for the season, consider the purchase of a boat lift. Boat lift prevent the build-up of marine growth on the hull as well as protecting from damage typical of on-water storage such as blistering. Make sure the boat lift supports the hull correctly, see **Lifting the Boat**, page 21.

LIFTING THE BOAT

If the boat is to be hoisted from the water, use the lifting eyes if possible. They are designed for easy, damage-free lifting.

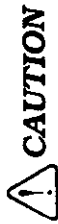

CAUTION

DO NOT use the ski pylon for lifting. It is NOT designed as a central lifting point. Also, DO NOT use the stern ski tow as a lifting ring, the deck will be damaged.

Never lift a boat with a large amount of water in the bilge. The extra stress will put a load on the hull and lifting equipment.

Using Lifting Eyes

An overhead hoist with at least a 2-1/2 ton capacity should be used. Cables should be rated for at least 4375 lbs each. When lifting, keep the bow slightly higher than the stern to prevent any possibility of water running into the engine exhaust manifold.

Using Lifting Slings

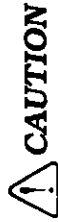

CAUTION

Lifting slings must never contact shafts, struts or hardware protruding from the hull. Damage caused by slings will void the warranty.

An overhead hoist with at least a 2-1/2 ton capacity should be used. Slings must be 6 inches wide by 20 feet long and a minimum capacity of 4375 lbs each. Use a 7' spreader bar on each sling to prevent damaging side pressure to the deck or gunwale molding.

Storage Cradle



CAUTION

When your boat is out of the water, it is important to support the hull correctly to avoid any hull damage which will void the warranty.

If a storage cradle is used, the hull must be properly supported to prevent load damage. Load damage can occur with as little as 15 pounds per square inch of pressure. **DO NOT** support the boat by resting the hull on the keel. Vertical supports must extend from the chine to the keel with no gaps between the hull and cradle supports. A total support area of at least 270 square inches is required for proper support.

Protect all items extending from the hull from resting on the cradle or the ground. **DO NOT** apply any load stress to the prop, shaft, rudder, swim platform, etc.

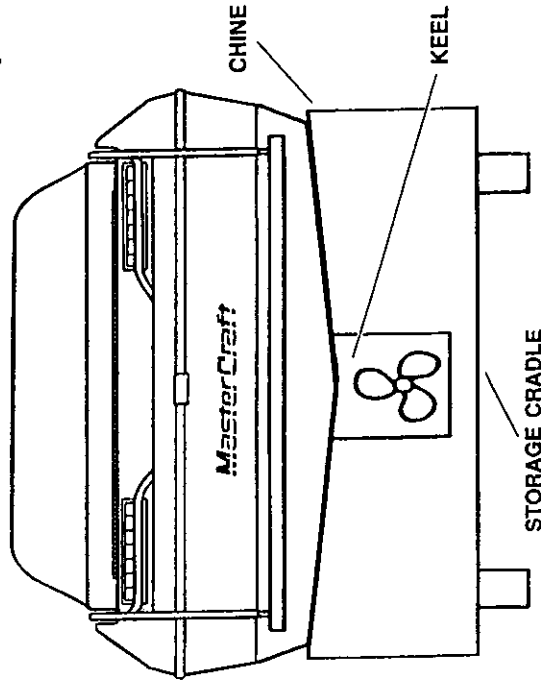

MCBM115

MariStar 240 Open Bow Shown

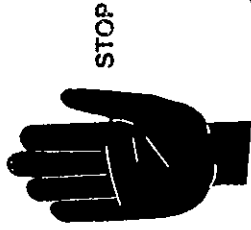

STOP

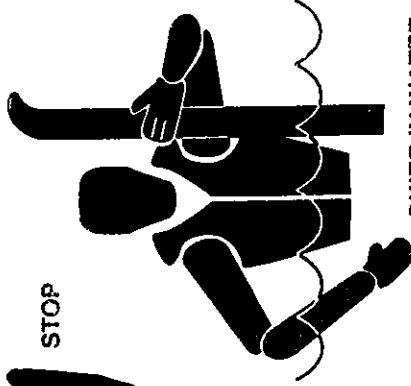

SKIER IN WATER



SPEED FASTER

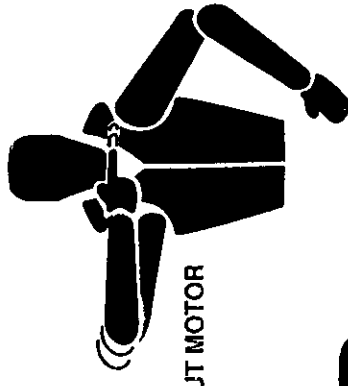

CUT MOTOR



SPEED SLOWER

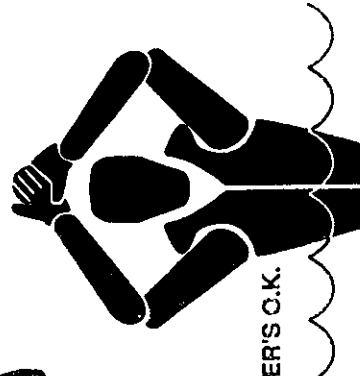

SKIER'S O.K.

CORROSION

Galvanic Corrosion - Galvanic corrosion (electrolysis) to the boater is the decomposition of metals, due to the effects of electrolytic action. When two dissimilar metals are immersed in a conductive fluid (salt water), an electric current is produced, much like a battery. As the current flows, it takes with it tiny bits of the softer metal. If left unchecked, a great deal of damage could occur.

If you operate in salt, polluted or brackish waters, your boat should be equipped with a transom mounted zinc anode to prevent damage to those metal parts coming in contact with the water. The zinc is, by design, self-sacrificing. It is slowly eroded away by electrolytic action and requires periodic inspection for deterioration. If the zinc shows extreme erosion, it must be replaced to continue protection or damage to other metal parts may result.

Salt Water Corrosion - Your boat has been designed for operation in fresh water. Fresh water internal flushing is required when used in salt, polluted or brackish waters. Flush the entire engine cooling system with fresh water for at least 5 minutes after use in these waters.

Marine Growth - If accelerated marine growth is a problem in your area, an anti-fouling bottom paint may be necessary to slow growth and prevent gelcoat damage. Before selecting a bottom paint, talk with other boaters and your MasterCraft dealer to determine which product works best in your area. Many local variables can affect the selection of paint. Be sure to follow the paint manufacturer's directions exactly.

CLEANING

Periodic cleaning is the best way to keep your boat looking like new. Regular washing and waxing keep dirt and scum from building up and deteriorating the finish. Keeping your boat in a "show-room new" condition results in personal satisfaction and higher resale value.

Your boat is made of fiberglass, a plastic resin material that is easy to clean and care for. Several layers of resin material are chemically bonded together to form the hull. The smooth outside surface of the hull is a layer of gelcoat resin. While the gelcoat is solid color, the thickness of the layer is only a few mils thick; much like paint on a car but much tougher and chemically bonded. Beneath the gelcoat surface is a series of layers of chemical resin, fiberglass mat, and woven roving. It is these layers that give the boat its strength and keep the hull shape. The boat bottom also uses special core-mat material for its strength to weight and superior marine performance.

Hull - When washing the boat, be sure to use a mild detergent and warm water solution. DO NOT use abrasive cleaners, solvents, ammonia or chlorine as these will damage the gelcoat surface. Under extreme conditions, special cleaners may be used to remove marine growth from the hull; see your MasterCraft dealer.

Waxing the entire gelcoat surface at least twice a season is recommended for all climates. Use of a specially formulated marine gelcoat wax will prevent color fade and soil and scum adhesion. If the gelcoat has chalked or faded from lack of proper maintenance, buffing may be necessary to bring back the shiny appearance. Hand buffing with #7 rubbing compound or power buffing with glazing compound #1 will quickly restore the surface.

Upholstery - Regular washing with mild detergent and warm water or automotive vinyl cleaners is sufficient to keep the cushions and vinyl covering in good condition. Keep the cushions from becoming soaked and dry off thoroughly after washing to prevent mildew accumulation after the boat is covered. Prop the cushions up in the boat when covered to allow air circulation and spray with milder repellent.

Carpet - Occasional washing with mild detergent and warm water or household carpet cleaners will keep the carpet clean. Thoroughly hose the detergent out of the carpet and into the bilge. This is usually the best time to clean the bilge also. Allow the boat to set uncovered in the sun for several days to prevent any mildew or odor caused by moisture.

Windshield - Cleaning the windshield when needed is an important safety precaution. The windshield is made of laminated plastic and tempered safety glass and requires special cleaning to prevent scratches to the surface. Use a mild soap solution and **damp** cloth only. Harsh detergents, solvents, chemicals or dry cloths will scratch the surface.

Stainless Steel and Chrome - Stainless steel and chrome plated parts are not totally resistant to corrosion. Occasional cleaning and polishing with a marine chrome and stainless polish will maintain and extend the useful life. In salt water areas rinse all hardware with fresh water and apply a light coating of protective oil to enhance appearance.

Sun Top and Boat Cover - Occasional cleaning of the top and cover should be done with mild soap and warm water. Thoroughly wet the entire surface and use a soft bristled brush. Rinse completely and allow to drip dry, then allow it to lay in the sun until completely dry. Treat with a water repellent as necessary.

For heavy soil or mildew, a solution of 1/2 cup bleach, 1/4 cup household soap and one gallon of water may be used for soaking. DO NOT allow to soak for more than 20 minutes to prevent deterioration of the stitching. Rinse completely and allow to drip dry, then allow it to lay in the sun until completely dry.

SCHEDULED MAINTENANCE CHECKS AND SERVICES

Proper care, maintenance and adjustment will contribute to the peak performance of the boat and extend the overall service life and resale value.

Use the table to the right to establish your maintenance routine. The instructions are grouped by the required service intervals. The pages that follow contain instructions and how to accomplish each of the required checks, inspections and services as listed in the table. The intervals are New Boat Break-In (first 50 hours), Daily (before each Boat Break-In (first 50 hours), Quarterly (every 3 months or every 50 hours), and Annually (each year or every 100 hours) whichever occurs first. The following definitions apply to maintenance:

Check - To verify operational readiness by physical measurement i.e., measuring oil level with dipstick gauge or alignment with a feeler gauge.

Inspect - To determine operational readiness by examination i.e., by sight, sound, or feel.

Change - Tasks required periodically to keep the boat in proper operating condition i.e., to drain, replenish or service.

Frequency and Scheduled Maintenance Task Table

New Boat Break-In

- Change engine oil and filter after initial 10 and 50 hours of operation. (See Quarterly and Annual Maintenance)
- Lubricate engine starter gear and shaft. (See Quarterly Maintenance)
- Check alignment of propeller shaft coupling. (See Annual Maintenance)

Before Each Use (Every 8 Hours)

- Check engine oil level.
- Check transmission fluid level.
- Check cooling system level (fresh water cooling equipped boats only).
- Check engine V-belts for looseness or damage.
- Check/service fuel filter/water separator.
- Inspect drivetrain for loose or missing hardware.*
- Inspect throttle and shift cables for kinks, wear and interference with other components.
- Inspect battery connections and hold-downs.
- Inspect exhaust system for leaks.
- Inspect propeller shaft log for excessive water entry.
- Inspect fuel system lines and connections for leakage.

Quarterly (Every 50 Hours)

- Change engine oil.
- Lubricate engine starter gear and shaft.
- Check safety equipment.

Annually (Every 100 Hours)

- Change engine oil filter.
- Clean engine flame arrestor.
- Clean carburetor fuel screen.
- Replace fuel filter element.
- Clean fuel tank pick-up.
- Perform engine tune-up.
- Change transmission fluid.
- Clean battery terminals.
- Check propeller shaft coupling alignment.
- Lubricate steering system.
- Lubricate shift and throttle cables.
- Inspect exhaust flaps for damage.*
- Check engine mounts.
- Inspect complete fuel system for leakage.

* Best accomplished with boat out of water.

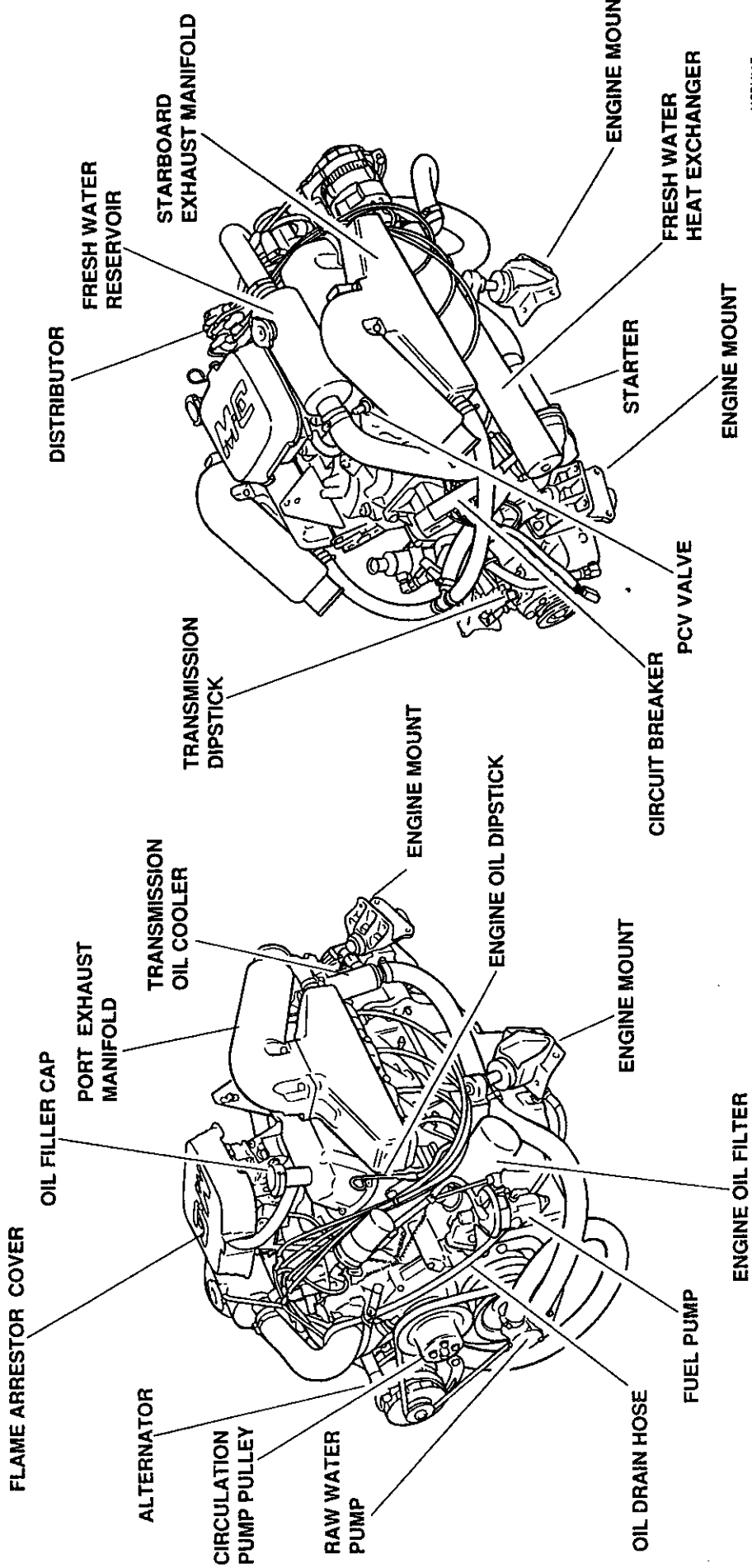

MasterCraft Power Ford 351 With Fresh Water Cooling System Shown

BEFORE EACH USE (Every 8 Hours)

Check Engine Oil Level

1. Operate engine for about 3 minutes or until warm. Turn engine OFF and disconnect engine safety starting switch.
2. Open engine box and locate engine oil level dipstick.

3. Remove dipstick and wipe off with a clean rag. Re-insert dipstick fully and immediately remove. Check that oil level is between the "ADD" and "SAFE" marks on the dipstick.
4. Add oil if necessary through oil filler in valve cover. Use only the recommended automotive type motor oil, see **Specifications** on page 39. Never mix different types/brands of oil.

Check Transmission Fluid Level

1. Operate the boat for about 5 minutes to warm transmission fluid. Turn engine OFF and disconnect engine safety starting switch; be sure that throttle/shift control lever is in neutral.

2. Open engine box and locate transmission fluid level dipstick.

NOTE

Transmission fluid level must be checked immediately after engine shut-down to prevent an incorrect reading. Oil drains back into the transmission from the cooler and cooler lines and could give a false reading if not done quickly.

3. Remove dipstick and wipe off with a clean rag. Quickly re-insert dipstick fully and immediately remove. Check that fluid level is at the "FULL WARM" mark on the dipstick.

4. Add or remove fluid as necessary to maintain level at the mark. Use only the recommended automotive transmission fluid, see Specifications on page 39. Never mix different types/brands of fluid.

Check Cooling System Level

(Fresh Water Cooling Equipped Boats Only)



CAUTION
Engine must be cool when checking the coolant level. Hot coolant and steam under pressure may cause personal injury.

1. Open engine box and remove reservoir cap.
2. Maintain coolant level to top of reservoir filler neck.

Check Engine V-Belts for Looseness or Damage

1. Turn engine OFF and disconnect engine safety starting switch; be sure that throttle/shift control lever is in neutral.

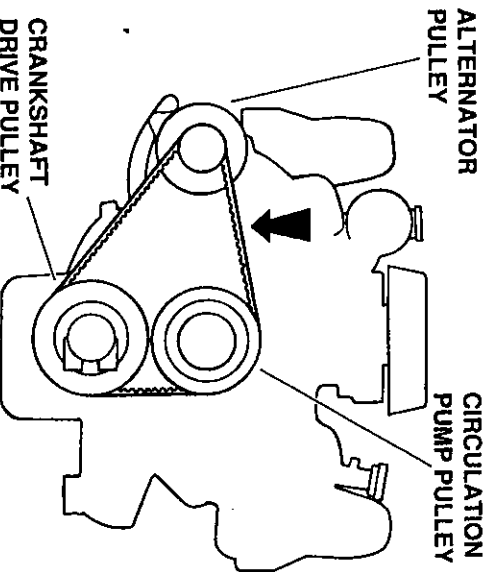

2. Open engine box and locate engine V-belts.

3. Check alternator belt tension on top midway between the circulating pump pulley and the alternator pulley. The belt should be tight enough so that it will deflect 1/4" - 1/2" when pressed with the thumb.

IMPORTANT
If the belt is too tight, excessive belt and bearing wear can occur. If the belt is too loose, slippage can occur resulting in low alternator output and rapid belt wear.

4. If the belt needs adjustment, loosen the alternator mounting hardware, pivot the alternator as needed, and tighten the hardware. Recheck belt tension.

Check/Service Fuel Filter/Water Separator



WARNING
Gasoline is highly flammable, and its vapors may result in fire or explosion. Be particularly cautious when working on any part of the fuel system. Be sure that the engine has cooled completely and keep all sparks and flames well away from the area. Never smoke when working on the fuel system. Take care not to spill any gasoline; if gasoline is spilled accidentally, wipe up all traces of it immediately with dry rags and dispose of the rags properly on shore.

1. Turn engine OFF and disconnect engine safety starting switch; be sure that throttle/shift control lever is in neutral. Engine must be cool.
2. Open the engine box and locate the fuel filter/water separator.

3. Place a clean catch container beneath the fuel filter assembly.

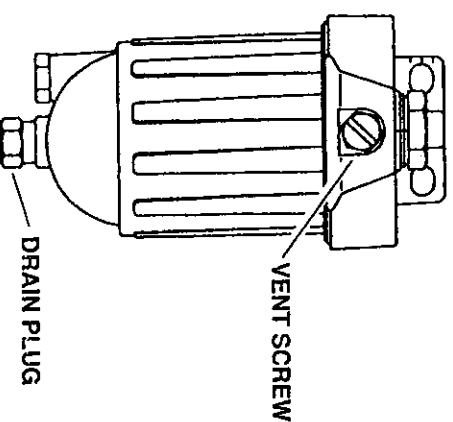

- Remove the drain plug from the bottom of the filter assembly, then loosen the vent screw at the top of the filter to allow the bowl to drain.
- Tighten the vent screw, install the drain plug and remove the catch container being careful not to spill.
- Analyze the fuel in the drain pan for signs of water and sediments. Water is heavier than gasoline and will therefore appear as bubbles at the bottom of the container. If large amounts of water/sediment are frequently found in the fuel, clean the fuel tank thoroughly.

Inspect Engine for Loose or Missing Hardware

- Turn engine OFF and disconnect engine safety starting switch; be sure that throttle/shift control lever is in neutral. Engine must be cool.
- Thoroughly and systematically check the entire engine for loose and missing hardware by sight. Try to shake components such as the alternator by hand. If a looseness problem persists, see your MasterCraft dealer.

Inspect Throttle and Shift Cables for Kinks, Wear and Interference

- Turn engine OFF and disconnect engine safety starting switch; be sure that throttle/shift control lever is in neutral. Engine must be cool.
- Open engine box and locate the throttle and shift cables. Follow each cable back under the floorboards and feel for kinks and wear on the outer jacket. Any sign of cable damage is cause for replacement; see your MasterCraft dealer.

Inspect Battery Connections and Hold-downs



WARNING

Battery electrolyte fluid is dangerous. It contains sulfuric acid which is poisonous, corrosive and caustic. If electrolyte is spilled or splashed on any part of the body, immediately flush the area with large amounts of clean water and seek medical aid immediately.

When charging, batteries generate small amounts of dangerous hydrogen gas. This gas is highly explosive. Keep all sparks, flames and smoking well away from the area.

- Lift the middle rear seat and locate the battery.
- Check that the battery post connections are clean and tight. If not:
 - Loosen and remove the negative terminal connection first. Be careful not to touch the positive terminal with the wrench.
 - Loosen and remove the positive terminal connection.
 - Remove battery hold-downs and remove battery from boat.
 - Clean corrosion from battery posts with a putty knife. Clean battery with a water and baking soda solution. Use care not to allow solution to enter battery vents. Rinse battery with fresh water.
 - Use a battery terminal cleaning brush to remove corrosion from the inside of the battery terminals. Clean the terminals with a water and baking soda solution and rinse.
 - Reconnect the positive terminal first and then the negative. Tighten the terminals. Coat both terminals completely with a thin covering of marine grease. Be sure that the rubber boot covers the positive terminal completely.

BATTERY

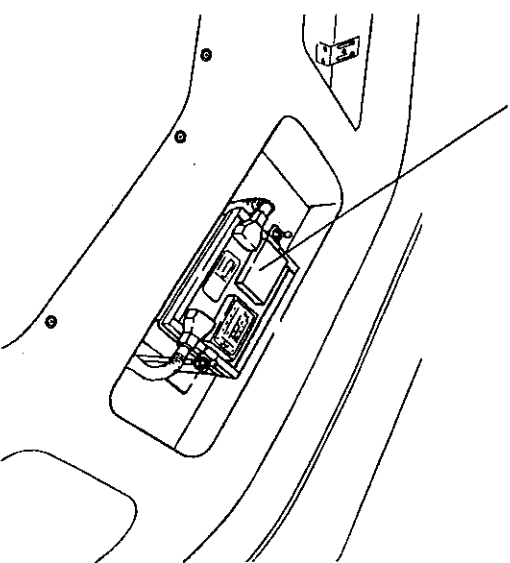

MGBW120

Inspect Exhaust System for Leaks

- Turn engine OFF and disconnect engine safety starting switch; be sure that throttle/shift control lever is in neutral. Engine must be cool.
- Visually check the exhaust system from the engine to the transom for obvious damage.



WARNING

The engine box serves as a machinery guard. The engine must be OFF whenever the box is opened except for access during maintenance. Use extreme care whenever operating the engine with the box open. Clothing or body parts can get caught up in moving parts causing extreme personal injury or death. Keep away from rotating parts.

3. Start engine with the engine box open.
4. Check hose connections between exhaust manifolds and mufflers for leakage.
5. If leakage is apparent, tighten hose clamps. See your MasterCraft dealer for parts and service.

Inspect Propeller Shaft Log for Excessive Water Entry

1. Turn engine OFF and disconnect engine safety starting switch; be sure that throttle/shift control lever is in neutral.
2. With the boat in the water, check for static leakage. No leakage is permissible when the propeller shaft is not rotating.
3. With another person operating the boat at cruising speed, inspect the shaft log for leakage. Ten to fifteen drops of water per minute is normal when the propeller shaft is rotating. If water entry is excessive, adjust the packing gland nut. To adjust:
 - a. Turn engine OFF.
 - b. Loosen packing gland lock nut.
 - c. Hand tighten packing gland nut, and re-tighten lock nut.
 - d. Operate the boat and check for proper adjustment. If water leakage continues, the shaft log must be re-packed; see your MasterCraft dealer.

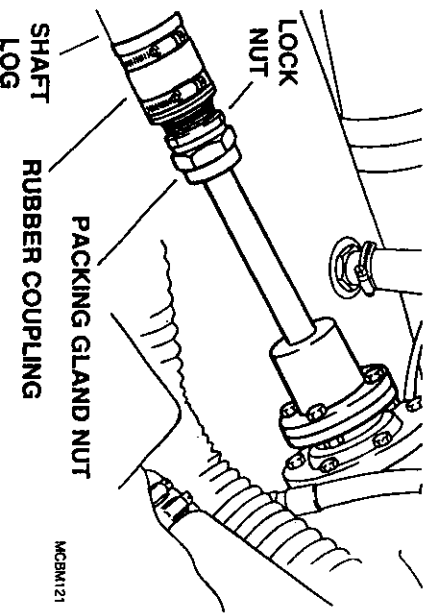

4. Check the rubber coupling for leakage. No leakage is permissible. If leakage is apparent, see your MasterCraft dealer.

Inspect Fuel System for Leakage

⚠ WARNING

Gasoline is highly flammable, and its vapors may result in fire or explosion. Be particularly cautious when working on any part of the fuel system. Be sure that the engine has cooled completely and keep all sparks and flames well away from the area. Never smoke when working on the fuel system. Take care not to spill any gasoline; if gasoline is spilled accidentally, wipe up all traces of it immediately with dry rags and dispose of the rags properly on shore.

1. Turn engine OFF and disconnect engine safety starting switch; be sure that throttle/shift control lever is in neutral. Engine must be cool.

⚠ WARNING

The engine box serves as a machinery guard. The engine must be OFF whenever the box is opened except for access during maintenance. Use extreme care whenever operating the engine with the box open. Clothing or body parts can get caught up in moving parts causing extreme personal injury or death. Keep away from rotating parts.

2. Open engine box and visually check the fuel system from the filter to the carburetor for obvious leakage.
3. Start the engine and look for leakage; stop engine immediately if leakage is seen. Leak must be repaired before the engine is re-started. See your MasterCraft dealer.

QUARTERLY (Every 50 Hours)

Change Engine Oil

1. Start and run engine until warm. Turn engine OFF and disconnect engine safety starting switch; be sure that throttle/shift control lever is in neutral.
2. Open engine box and locate the oil drain hose.
3. Remove the engine oil filler cap. This will speed up the oil draining process.

NOTE

If boat is on trailer, it may be easier to remove the bilge drain plug and drop drain hose through hole. Drain oil into a container on the ground.

4. Attach a suction pump to the drain hose and remove oil completely.
5. Change oil filter if necessary.
6. Cap oil drain hose and refill crankcase through filler opening. See **Specifications**, page 39, for recommended oil type. Check oil level with the dipstick.

IMPORTANT

Never drain oil into the bilge or into the water. Wipe up spilled oil immediately and dispose of rags and drain oil properly on shore.

Lubricate Engine Starter Gear and Shaft

1. Turn engine OFF and disconnect engine safety starting switch; be sure that throttle/shift control lever is in neutral. Engine must be cool.
2. Open engine box and locate the starter.
3. Disconnect starter and remove from the engine.
4. Lubricate the starter bendix with a light coating of spray lubricant such as WD 40 or LPS 1.

ANNUALLY

Change Engine Oil Filter

1. Drain engine oil. See **Change Engine Oil**, page 27.

NOTE

When filter is removed, some oil will spill. Place a small catch container beneath the filter area and keep rags handy for clean-up.

2. Spin off old engine oil filter and discard filter and rags properly on shore.
3. Lightly lubricate the filter gasket of the new filter with clean motor oil.
4. Screw the filter by hand until the gasket just touches the block and then tighten it one-half turn more by hand. DO NOT use a filter wrench to tighten.
5. After filling the engine with oil, start the engine and check the area around the filter for leaks. Check oil level and adjust if necessary.

Clean Engine Flame Arrestor

1. Turn engine OFF and disconnect engine safety starting switch; be sure that throttle/shift control lever is in neutral. Engine must be cool.
2. Open engine box and locate the flame arrestor.
3. Remove the bolt securing the cover on the flame arrestor. Remove the cover.
4. Disconnect the crankcase and fuel pump ventilation hoses. Inspect hoses for damage; replace if necessary.
5. Remove the flame arrestor and inspect for damage; replace if necessary.
6. Clean the flame arrestor and ventilation hoses in solvent and blow dry with low pressure compressed air.
7. Install flame arrestor, connect hoses and install cover.

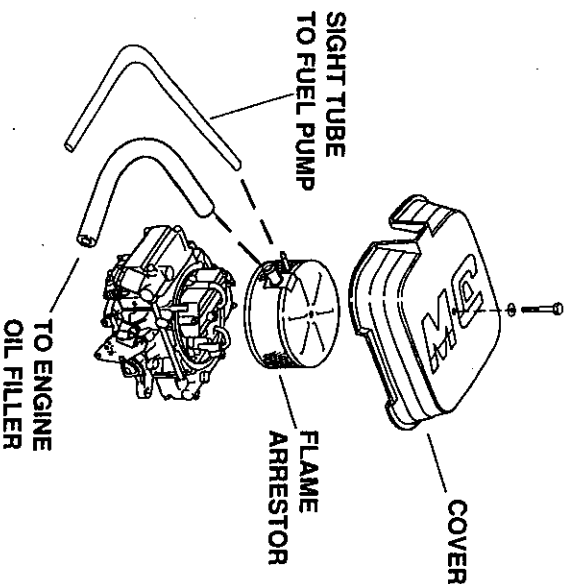

MCBM122

Clean Carburetor Fuel Screen

1. Turn engine OFF and disconnect engine safety starting switch; be sure that throttle/shift control lever is in neutral. Engine must be cool.
2. Open engine box and locate the fuel supply tube.



WARNING

Gasoline is highly flammable, and its vapors may result in fire or explosion. Be particularly cautious when working on any part of the fuel system. Be sure that the engine has cooled completely and keep all sparks and flames well away from the area. Never smoke when working on the fuel system. Take care not to spill any gasoline; if gasoline is spilled accidentally, wipe up all traces of it immediately with dry rags and dispose of the rags properly on shore.

3. Remove fuel supply tube between the fuel pump and carburetor. Inspect tube for damage; replace if necessary.



WARNING

Safety glasses should always be worn when using compressed air to avoid eye injury.

4. Remove filter nut, washers and screen. Clean screen with solvent and blow dry with low pressure compressed air.
5. Install screen, washers, filter nut and tube. Torque filter nut to 18 lb ft.
6. Install fuel supply tube between fuel pump and carburetor. While holding filter nut with wrench, torque tube nuts to 18 lb ft.

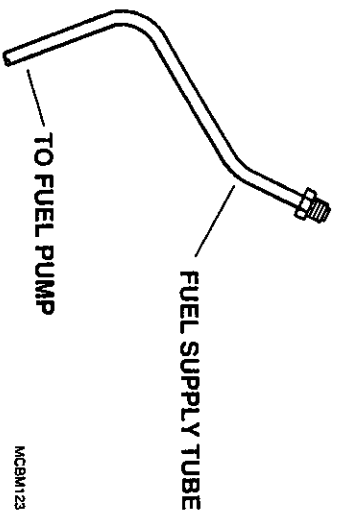
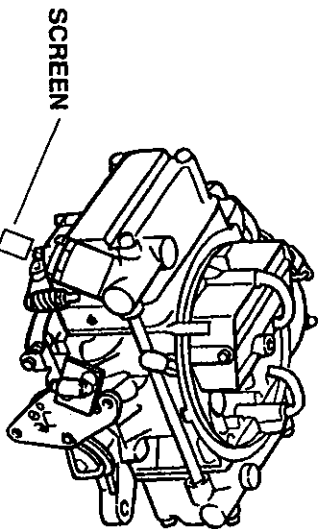

7. Start the engine and check the area around the screen and tube for leaks. If leakage occurs, stop the engine immediately and reset the connections; if leakage continues to occur, stop engine and consult your MasterCraft dealer immediately.

Replace Fuel Filter Element

1. Turn engine OFF and disconnect engine safety starting switch; be sure that throttle/shift control lever is in neutral. Engine must be cool.
2. Open engine box and locate the fuel filter.



WARNING

Gasoline is highly flammable, and its vapors may result in fire or explosion. Be particularly cautious when working on any part of the fuel system. Be sure that the engine has cooled completely and

keep all sparks and flames well away from the area. Never smoke when working on the fuel system. Take care not to spill any gasoline; if gasoline is spilled accidentally, wipe up all traces of it immediately with dry rags and dispose of the rags properly on shore.

3. Drain fuel bowl, see Check/Service Fuel Filter/Water Separator, page 25.

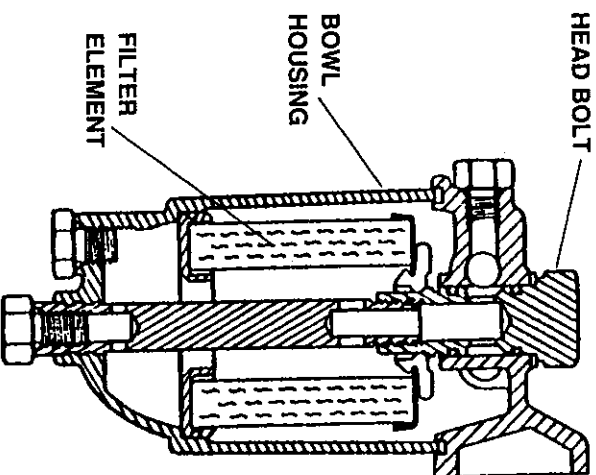

4. Remove head bolt and bowl housing.
5. Remove and discard filter element properly on shore.
6. Clean housing, gasket gland and gasket with solvent and blow dry with low pressure compressed air.
7. Install new element into housing.
8. Install bowl housing and head bolt. Torque head bolt to 65 lb in.

Clean Fuel Tank Pick-Up

1. Turn engine OFF and disconnect engine safety starting switch; be sure that throttle/shift control lever is in neutral. Engine must be cool.



WARNING

Gasoline is highly flammable, and its vapors may result in fire or explosion. Be particularly cautious when working on any part of the fuel system. Be sure that the engine has cooled completely and keep all sparks and flames well away from the area. Never smoke when working on the fuel system. Take care not to spill any gasoline; if gasoline is spilled accidentally, wipe up all traces of it immediately with dry rags and dispose of the rags properly on shore.

2. Remove aft interior panels in sun deck storage area to access fuel tank cluster.
3. Loosen hose clamp and remove fuel pick-up hose from tank.

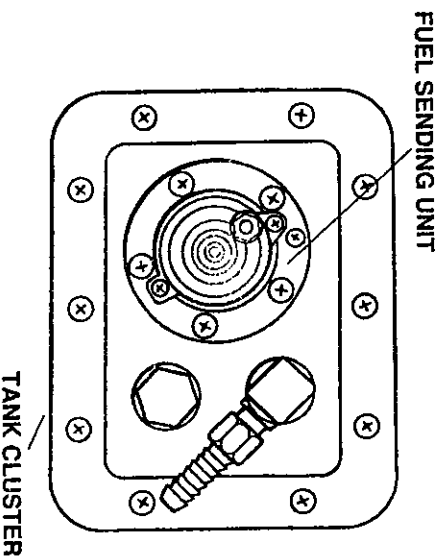

MCGM125

4. Remove screws securing the sending unit to the cluster and remove sending unit.
5. Remove screws securing the cluster to the fuel tank and remove the cluster.
6. Clean screen at end of pick-up tube and inspect for damage.
7. Inspect inside tank for accumulations of dirt and debris. See your MasterCraft dealer if large amounts of dirt/debris are found.
8. Install the cluster and secure with screws.
9. Install the sending unit and secure with screws.
10. Connect fuel pick-up hose and secure with hose clamp. Tighten hose clamp.

Engine Tune-Up

A complete engine tune-up, which includes re-placement of PCV valve, spark plugs, points, condenser, distributor cap, rotor, and ignition wires (if needed), and adjustments for spark, dwell and idle, requires special knowledge, tools and test equipment.

For this reason, we have not included step-by-step information in this manual as it is beyond the capabilities of most of our customers. For the convenience of those familiar with engine tune-ups, we have included the parameters in the **Specifications** section, page 39.

Change Transmission Fluid

1. Run boat to bring boat to normal operating temperature. Turn engine OFF and disconnect engine safety starting switch; be sure that throttle/shift control lever is in neutral.

2. Open engine box and locate transmission.
3. Loosen the hose clamps on the starboard exhaust hose. Remove the exhaust hose.
4. Remove the transmission dipstick.
5. Use a suction pump through the oil filler opening to remove oil from the transmission.
6. Refill transmission with fluid through filler opening. See **Specifications**, page 39, for capacities and recommended fluid type.

Check Propeller Shaft Coupling Alignment

1. Turn engine OFF and disconnect engine safety starting switch; be sure that throttle/shift control lever is in neutral. Engine must be cool.

PROPELLER SHAFT COUPLING

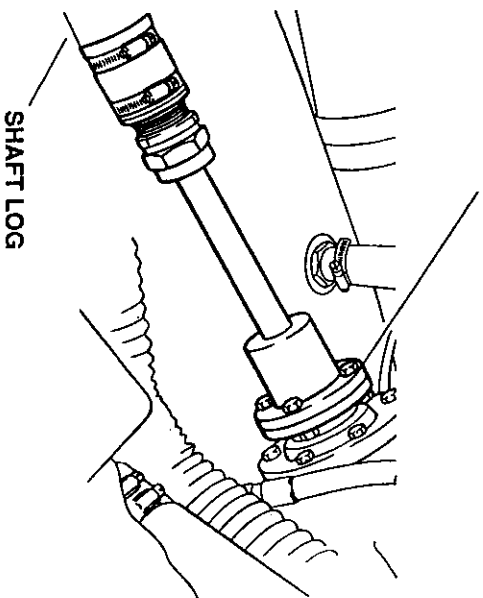

2. Open the engine box and locate the propeller shaft coupling.

3. Remove the coupling bolts and slide the coupling apart only slightly so that the pilot flange on the propeller shaft side is still seated in the pilot bore of the transmission side.
4. Using a feeler gauge, measure the gap between the coupling halves at four places. Rotate the coupling flanges together one complete revolution, stopping every 90° to check clearance with the feeler gauge.
5. Alignment is satisfactory when the flanges are parallel within 0.003 inch.
6. If alignment is not satisfactory, an adjustment must be made. Special tools and techniques are required for proper adjustment and should only be made by a skilled mechanic; see your MasterCraft dealer.
7. If alignment is satisfactory, install flange bolts and tighten securely.
8. Water test to ensure that there is no vibration. If vibration is noticeable, see your MasterCraft dealer immediately.

Lubricate Steering System

1. Turn engine OFF and disconnect engine safety starting switch; be sure that throttle/shift control lever is in neutral. Engine must be cool.
2. Raise sun deck to access storage area.
3. Remove screws securing aft interior panels and floorboard in storage area. Remove panels and floorboard.
4. Turn steering wheel so that the maximum amount of steering cable is seen.
5. Use solvent to clean old lubricant from cable end, pivot and rudder shaft.

6. Spread a generous amount of waterproof marine multipurpose grease over cable end. Work steering wheel several times back and forth and re-apply grease if necessary.

7. Using a flexible end on a grease gun, give two full shots of waterproof marine multipurpose grease to three fittings; one on the rudder shaft, one on the tube and one on the pivot. Clean up any old grease purged from the areas.

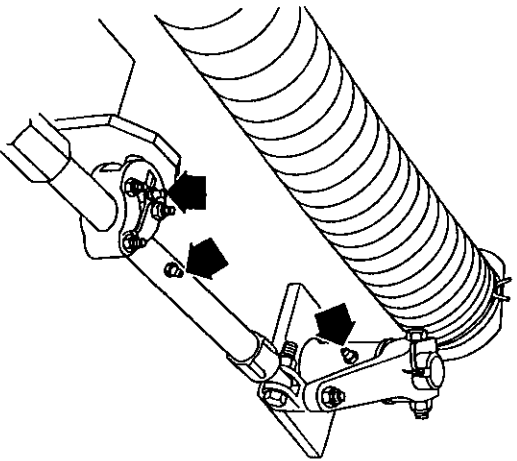

MC9M127

8. Work the steering wheel back and forth several times to work lubricant in.
9. Install the panels and floorboard in sun deck storage area.

Lubricate Shift and Throttle

Cables

1. Turn engine OFF and disconnect engine safety starting switch; be sure that throttle/shift control lever is in neutral. Engine must be cool.
2. Open engine box and locate shift and throttle cable ends.

3. Shift to full-throttle-forward.

4. Lubricate the cable ends and connections with a coat of waterproof marine multipurpose grease.

5. Lubricate pivots and linkages with a light grease.

6. Work the control lever from full-throttle-forward to full-throttle-reverse several times to work lubricant in.

Inspect Exhaust Flaps for

Damage

1. Turn engine OFF and disconnect engine safety starting switch; be sure that throttle/shift control lever is in neutral.

2. Inspect exhaust flap hinge for signs of deterioration. Replace flaps if necessary.

3. Check that hose clamps securing the flaps are tight. Tighten hose clamps if necessary.

Check Engine Mounts

1. Turn engine OFF and disconnect engine safety starting switch; be sure that throttle/shift control lever is in neutral. Engine must be cool.

2. Open the engine box and locate the four motor mounts.

3. Check the tightness of the mounting hardware and adjustment locknuts. Tighten any loose hardware securely.

Inspect Complete Fuel

System for Leakage

1. Turn engine OFF and disconnect engine safety starting switch; be sure that throttle/shift control lever is in neutral. Engine must be cool.

WARNING

Gasoline is highly flammable; and its vapors may result in fire or explosion. Be particularly cautious when working on any part of the fuel system. Be sure that the engine has cooled completely and keep all sparks and flames well away from the area. Never smoke when working on the fuel system. Take care not to spill any gasoline; if gasoline is spilled accidentally, wipe up all traces of it immediately with dry rags and dispose of the rags properly on shore.

2. Raise sun deck to access storage area.

3. Remove screws securing aft interior panels in storage area. Remove panels.

4. Check fuel tank mounting points for cracks or other damage.

5. Check all hose connections for tightness.

6. Check fuel hoses for wear, kinks, cracking, deterioration or other damage.

WARNING

Any fuel system components replaced must meet USCG and ABYC standards and be UL approved. Inferior quality components pose a serious safety threat to you and others and their use may result in serious injury or death.

7. Replace all damaged components immediately. If new components are installed, start engine and look for any signs of leakage.

8. Install the sun deck storage area panels.

UNSCCHEDULED MAINTENANCE

Changing Propellers

Your boat has been fitted with a propeller that offers the best overall combination of performance. It may be necessary at times to change the propeller to meet certain operating conditions such as more speed (at the expense of torque) or more torque (at the expense of speed). In any case, consult your MasterCraft dealer for specific recommendations.

New propellers should be fitted to the shaft out of the water to assure good contact. To replace and fit a propeller, use the following procedure:

1. Turn engine OFF and disconnect engine safety starting switch. Place throttle/shift control lever in forward gear.
2. Remove and discard the cotter pin.
3. Remove the propeller nut.
4. Using a propeller puller, pull the old propeller off the shaft. Remove the key from the shaft keyway. Inspect key for damage; discard if damaged.
5. Use a honing stone to remove any small burrs or nicks from the tapered end of the propeller shaft.
6. Apply a thin layer of "Prussian Blue" to the tapered area of the propeller shaft.
7. Install the new propeller on the shaft and rotate it slightly from side to side. Remove the propeller.
8. Inspect the tapered area of the shaft. Where the propeller contacts the shaft the blueing will be gone. At least 60% contact is required. If the contact area is sufficient, go to step 11.
9. If the contact area is too small, apply a coat of coarse grinding compound to the taper area of the shaft. Install the propeller and rotate it on the shaft at least 100 times. Alternate every 10 revolutions between clockwise and counterclockwise rotation.
10. Remove the propeller and use solvent to clean the grinding compound from the propeller and shaft. Repeat steps 6, 7 and 8.
11. Thoroughly clean and apply a light coat of waterproof marine multipurpose grease to the taper area of the shaft.
12. Install the key into the keyway of the shaft. The key should fit tight from side to side in both the shaft and the propeller.
13. Install the propeller on the shaft, aligning the keyway with the key in the shaft. There should be a small amount of clearance between the key and propeller keyway. If there is no clearance, the propeller may be forced off center causing vibration.
14. For a three blade propeller, install the propeller nut and torque to 50 lb ft.
For an optional four blade propeller, install the propeller nut and torque to 25 lb ft.
Check the propeller nut torque periodically.
15. Install a new cotter pin and bend the ends around the shaft to lock the propeller on the shaft.

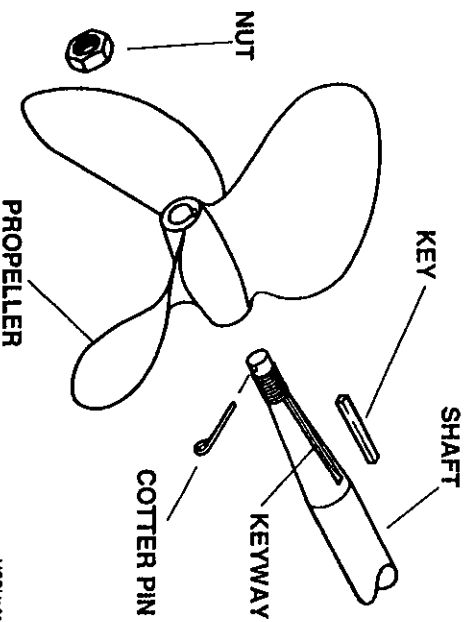

MCB1128

Replacing Fuses

The stereo has two inline fuses: one on the power (positive) wire and one on the memory wire. To access the fuse holders, open the observer's seat. The accessory switch also has an inline fuse. To access the accessory fuse, remove the screws securing the dash panel and pull the panel out a couple of inches. To open an inline fuse holder, grasp each end of the holder, push together and twist in opposite directions.

CIRCUIT	FUSE TYPE	RATING
Radio Power	ATC	3 Amp
Radio Memory	ATC	5 Amp
Accessory	311	10 Amp/32 Volt

Replacing Lights

BOW LIGHT - Remove screws securing light assembly to deck, pull light out a couple of inches, turn over and remove screws holding lens cover to base, remove lens cover and lenses. Grasp light and push into base, then slide up while twisting

out. During installation be sure that the red lens is to the port side of the boat and the green lens to starboard. Snug-up screws only, do not over-torque.

STERN LIGHT - Unscrew lens cover. Grasp bulb, push down and turn counterclockwise. Align lugs, push down and turn clockwise to install bulb.

INSTRUMENT LIGHTS - Remove screws securing dash panel, pull panel out a couple of inches. Locate affected instrument, grasp light base and pull base from back of instrument. Grasp bulb, push into base and turn counterclockwise. Align lugs, push down and turn clockwise to install bulb.

LOCATION	TRADE NUMBER	VOLTS/WATTS	BASE TYPE
*Bow	12854 (PERKO FIG. 71)	12/10	SV 8.5
Stem	1004	12.8/12	D.C. Bay.
Speedometer	53	14.4/1.7	Min. Bay.
Other Instruments	12829	12/2	BA 7s

BOATING TERMS

AFT - toward the stern or rear of the boat.

BILGE - lowest internal part of the boat hull.

BOW - front or fore part of the boat.

FENDER - an item used along side of the boat to decrease shock and prevent damage when docking.

FREEBOARD - distance from water line to the highest deck or the section of the boat which is above water level.

GUNWALE - uppermost part on side of the boat's frame. Also gunnel.

MOORING - a location in which the boat is held in place with lines, cable, chain or anchor.

PORT - the side of the boat located to the left of someone facing the bow.

RUDDER - a vertical, movable, plate attached at the stern to control direction of the boat.

STARBOARD - the side of the boat located to the right of someone facing the bow.

STERN - the aft or back end of the boat where rudder is located.

TRIM - the arrangement of weight in the boat that achieves proper balance fore and aft.

WAKE - the visible motion of water behind a moving boat.

STORAGE

Storage or winter lay-up requires special preparation to prevent damage to the boat. Since winter lay-up is an annual event, it is wise to perform all annual maintenance at this time. The natural excitement of getting the boat in the water as soon as possible the next season will make any maintenance unbearable at that time.

Without proper preparation, storage for long periods of time may cause internal parts of the engine and transmission to rust because of lack of lubrication. Or, if the boat is stored in below freezing temperatures, water inside the bilge or cooling system may freeze causing damage. Damage to the boat due to improper storage will void the warranty. The following procedures will help keep your boat from damage for a period of 5 months.

IMPORTANT

Anytime your MasterCraft will be idle for a period of 60 days or more, the engine should be drained of fuel to avoid fuel turning into gum or varnish in the carburetor which can result in engine damage. See your dealer for proper service before storage. It is the responsibility of the owner to ensure proper storage of the boat.

1. WHILE BOAT IS STILL IN WATER

- Fill fuel tank and add the proper amount of fuel stabilizer and conditioner according to the manufacturer's recommendations.
- Operate boat for at least 15 minutes to be sure that treated fuel has reached engine.

NOTE

If the boat is to be stored for more than 5 months, stored in a high moisture (humid) environment, in temperature extremes or outdoors, "fog" the engine with a rust preventa-

tive fogging oil according to the manufacturer's recommendations. See your MasterCraft dealer.

- Remove the attaching hardware from the propeller shaft coupling. Separate the flanges and coat flange surfaces with waterproof marine multipurpose grease.

2. WHEN BOAT IS REMOVED FROM WATER

IMPORTANT

If you do not have an optional MasterCraft trailer for your boat, you should consider a storage cradle. When the hull is supported improperly for a period of time, a great deal of hull damage can occur. MasterCraft trailers are designed to give your boat proper support for long term storage. See Lifting the Boat for more information on storage cradles.

NOTE

Remove the bilge drain plug immediately after taking the boat out of the water. After washing, raise the bow of the boat high to allow as much water as possible to drain while performing other storage preparations.

- Flush the engine cooling system with clean water. DO NOT exceed 1500 rpm when flushing.
- Perform all scheduled maintenance. Of special importance is tuning the engine and changing the oil and fuel filters.
- Thoroughly clean the hull, deck and interior of the boat as soon as it is removed from the water. Cleaning at this time is easier because the marine growth is still wet. Be sure to allow for a couple of days of air drying to prevent mildew due to trapped moisture. See **Cleaning**, page 22.

- Apply a coat of wax to the entire surface of the boat and rust inhibitor on all metal parts. See **Cleaning**, page 22.

- Clean all traces of dirt, oil, grime and grease from the engine, transmission and bilge. Touch-up areas of engine and transmission where paint has been removed.

- Remove drain plugs from the exhaust manifold.

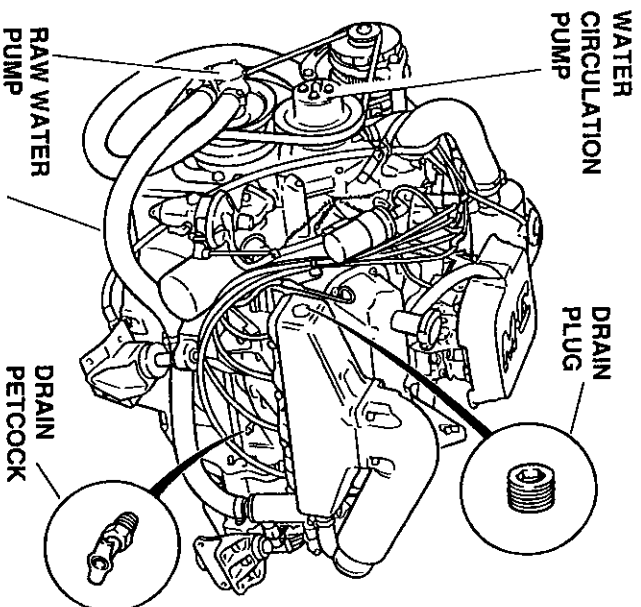

Ford 351 With Fresh Water Cooling System Shown

NC8W129

- Open the engine block drain petcocks on each side of the engine.
- Remove both hoses from the raw water pump. Blow through the bottom hose until all water has been removed from the transmission oil cooler. Bend/shake hoses as necessary to remove water droplets.

NOTE

If your boat is equipped with an optional fresh water cooling kit, skip steps i and j. Check that the coolant will provide protection below the lowest expected ambient temperature with a hydrometer.

- i. Remove the bottom hose from the engine water circulation pump.

IMPORTANT

Be sure that hoses will not become entangled in the engine V-belt when turning the engine over or hose/belt damage will occur.

NOTE

If your boat is equipped with an optional heater, remove both heater hoses. Blow through one hose to remove all water.

- j. With the engine safety starting switch **disconnected**, turn the engine over for about 2 - 3 seconds to remove the last traces of water.

k. Attach all hoses and tighten clamps securely. Store the exhaust manifold drain plugs, propeller shaft coupling hardware and bilge drain plug in a plastic bag and tape it to the throttle control lever so that it is easily found for reactivation.

1. Remove the battery from the boat. Clean, fully charge and store the battery in an area not subject to freezing temperatures. **Never store batteries directly on concrete floors, in basements or close to heat, spark or flame producing devices.**

m. Use duct tape to cover the carburetor air intake and seal the exhaust flaps to prevent dirt and nesting rodents from entering.

IMPORTANT

If the boat is to be stored outside and subject to accumulations of snow, water and ice, a support should be made for the boat cover so that it will not sag, rip or tear allowing water to enter the boat. Two inch PVC plumbing pipe is ideal for this purpose, is readily available at local hardware stores and is easy to work with. Also, its rounded shape will prevent damage to the canvas.

n. Remove all personal flotation devices, towels, blankets, clothing, lines and other items which might hold moisture and cause mildew. Prop up all seat cushions to allow air circulation around them. Remove any personal items that could freeze or deteriorate over time.

o. Remove propeller. Coat entire length of propeller shaft (inside and outside boat) with corrosion resistant metal protectant.

p. Cover the boat with a boat cover or tarp. See your MasterCraft dealer for other covering methods such as shrink wrapping.

q. Keep the bow of the boat at a slightly higher level than the stern to allow for moisture runoff.

3. REACTIVATING THE BOAT AFTER STORAGE

a. Remove duct tape from exhaust flaps and carburetor air intake.

b. Charge and install battery in boat.

c. Wrap two drain plugs with teflon sealing tape and install in exhaust manifold.

d. Close two engine drain petcocks on each side of block.

e. Check propeller shaft coupling alignment. Install and tighten coupling hardware.

f. Check engine compartment and bilge for signs of nesting animals; clean as necessary.

g. Refer to engine owner's manual for procedures to use engine after storage.

h. Check all hose clamps for tightness.

i. Install bilge drain plug.

j. Grease propeller shaft taper and install propeller.

k. Perform daily maintenance. If not performed during lay-up, perform annual maintenance.

l. If the boat is equipped with the optional fresh water cooling system and was drained for storage, fill the system with fresh coolant solution.

m. Take the boat to the water and start it. It may take a minute of cranking to allow the fuel pump to fill the carburetor bowl. Allow a two minute cool down period for every 30 seconds of cranking. When the engine fires, keep a close watch over the gauge readings and check for leakage and abnormal noises. Keep speeds low for the first 15 minutes until the engine has reached normal operating temperature.

WEATHER SIGNALS

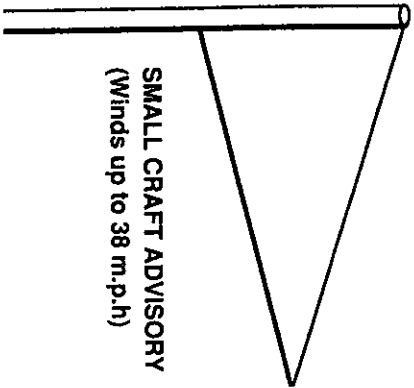

SMALL CRAFT ADVISORY
(Winds up to 38 m.p.h)

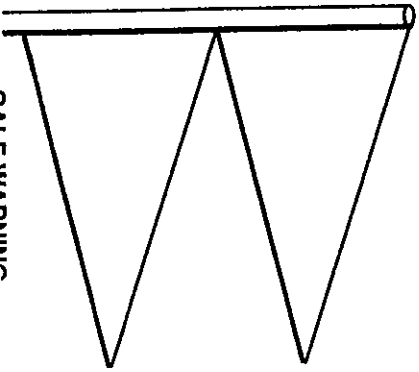

GALE WARNING
(Winds 39 to 54 m.p.h)

TROUBLESHOOTING

The following charts will assist you in finding and correcting minor mechanical and electrical problems with your boat. Problems are listed in order of the most likely to the least likely.

To correct a problem, first determine what the problem is. Start with the first cause and elimi-

nate the possibility of each until the problem is corrected. Because of the specialized skill and tooling needed to correct major damage, we have not included that information here: see your MasterCraft dealer.

PROBLEM	POSSIBLE CAUSE	SOLUTION
Engine will not crank.	<ol style="list-style-type: none"> 1. Throttle/shift control in gear. 2. Main circuit breaker open. 3. Battery terminals corroded. 4. Battery weak or worn out. 5. Loose or corroded battery wiring connections. 6. Defective starter solenoid. 7. Defective neutral safety switch. 8. Defective starter motor. 9. Defective ignition switch or wiring. 10. Water in engine (hydrostatic lockup). 11. Neutral safety switch not adjusted properly. 	<ol style="list-style-type: none"> 1. Shift to neutral. 2. Reset circuit breaker. 3. Clean battery terminals. 4. Charge or replace battery. 5. Clean and tighten battery wiring connections. 6. Replace starter solenoid. 7. Replace neutral safety switch. 8. Replace starter motor. 9. Replace ignition switch or repair wiring. 10. Remove spark plugs and look for water or gas in cylinders. See your dealer. 11. Adjust neutral safety switch.
Engine cranks but won't start.	<ol style="list-style-type: none"> 1. No fuel in tank. 2. Fuel filter clogged. 3. Contaminated fuel. 4. Weak or shorted ignition coil. 5. Distributor problems. 6. Points dirty. 	<ol style="list-style-type: none"> 1. Fill fuel tank. 2. Replace fuel filter. 3. Replace fuel and filter. 4. Replace ignition coil. 5. See your dealer. 6. Replace points.

PROBLEM	POSSIBLE CAUSE	SOLUTION
Engine hard to start.	<ol style="list-style-type: none"> 1. Flooded engine. 2. Plugged flame arrestor. 3. Fouled spark plugs. 4. Loose coil or ignition wires. 5. Battery cables loose or corroded. 6. Weak battery. 7. Distributor problems. 	<ol style="list-style-type: none"> 1. Start engine at full throttle and back off immediately. 2. Clean flame arrestor. 3. Replace spark plugs. 4. Tighten coil or ignition wires. 5. Clean and tighten battery cables. 6. Charge or replace battery. 7. See your dealer.
Engine misses or idles rough.	<ol style="list-style-type: none"> 1. Fouled spark plugs. 2. Loose or defective high tension leads. 3. Plugged PCV valve. 4. Weak ignition coil. 5. Vacuum leak. 	<ol style="list-style-type: none"> 1. Replace spark plugs. 2. Tighten or replace high tension leads. 3. Replace PCV valve. 4. Replace ignition coil. 5. See your dealer.
Poor boat performance.	<ol style="list-style-type: none"> 1. Fouled spark plugs. 2. Contaminated fuel. 3. Plugged flame arrestor. 4. Weak ignition coil. 5. Distributor problems. 	<ol style="list-style-type: none"> 1. Replace spark plugs. 2. Replace fuel and fuel filter. 3. Clean flame arrestor. 4. Replace ignition coil. 5. See your dealer.
Poor gas mileage.	<ol style="list-style-type: none"> 1. Fouled spark plugs. 2. Plugged flame arrestor. 3. Inefficient driving habits. 4. Plugged PCV valve. 5. Distributor problems. 	<ol style="list-style-type: none"> 1. Replace spark plugs. 2. Clean flame arrestor. 3. Plane boat quickly, then slow down to desired speed. 4. Replace PVC valve. 5. See your dealer.
Throttle/shifting problems.	<ol style="list-style-type: none"> 1. Corroded cables. 2. Defective throttle return spring. 3. Low transmission oil level. 4. Sticking transmission shift detent ball. 5. Kink in cable(s). 	<ol style="list-style-type: none"> 1. Clean and lubricate cables. 2. Replace throttle return spring. 3. Replenish transmission oil. 4. Clean and lubricate detent ball. 5. Replace cable(s). See your dealer.

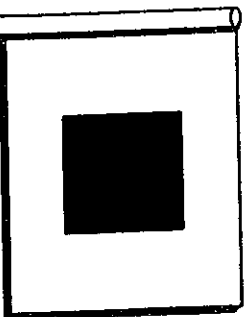

STORM WARNING
(Winds 55 to 73 m.p.h)

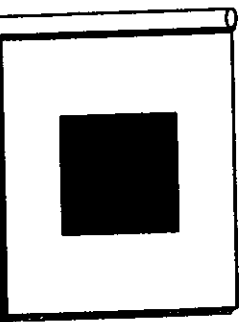

HURRICANE WARNING
(Winds over 73 m.p.h)

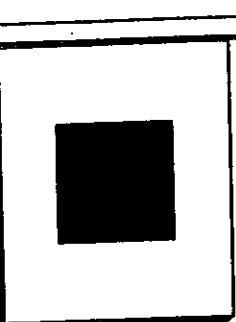

ANCHORS

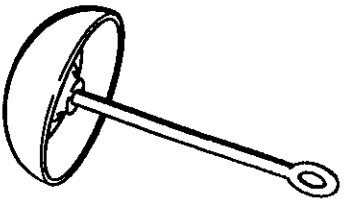

MUSHROOM

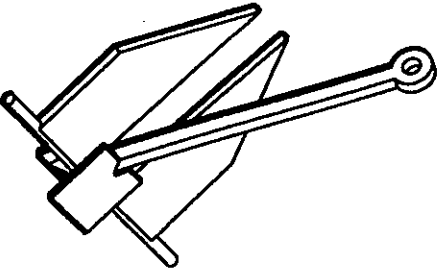

DANFORTH

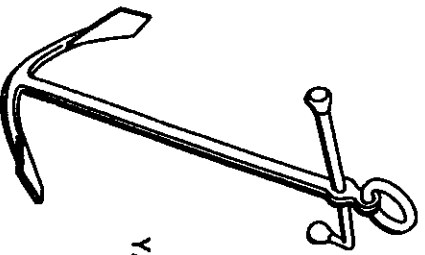

YACHTMAN'S

PROBLEM	POSSIBLE CAUSE	SOLUTION
Steering problems.	<ol style="list-style-type: none"> 1. Corroded cable. 2. Rudder worn. 	<ol style="list-style-type: none"> 1. Clean and lubricate cable. 2. See your dealer.
Excessive vibration.	<ol style="list-style-type: none"> 1. Fouled propeller. 2. Damaged propeller. 3. Misaligned engine. 4. Bent propeller shaft. 	<ol style="list-style-type: none"> 1. Remove objects from propeller shaft and rudder. 2. Replace propeller. 3. Check alignment. See your dealer for realignment. 4. See your dealer.
Electrical problems.	<ol style="list-style-type: none"> 1. Open circuit breaker or blown fuse. 2. Loose wiring connections or corrosion. 3. Defective sending unit. 4. Shorted wiring harness. 5. Defective switch or gauge. 	<ol style="list-style-type: none"> 1. Reset circuit breaker or replace fuse. 2. Clean and tighten wiring connections. 3. Replace sending unit. 4. Repair wiring harness, see your dealer. 5. See your dealer.
No speedometer reading.	<ol style="list-style-type: none"> 1. Disconnected, kinked or plugged tubing. 2. Plugged pitot pick-up. 3. Defective pitot pick-up. 4. Defective speedometer. 	<ol style="list-style-type: none"> 1. Repair or replace tubing. 2. Remove objects from pitot pick-up. 3. Replace pitot pick-up. 4. Replace speedometer.
Incorrect speedometer reading.	<ol style="list-style-type: none"> 1. Blocked pitot. 2. Water in tubing. 3. Defective speedometer. 	<ol style="list-style-type: none"> 1. Remove blockage. 2. Disconnect tubing at speedometer and blow out tubing. Tighten nut finger tight, then 1/4 turn more. 3. Replace speedometer.

SPECIFICATIONS

Boat

MarStar 240 Open Bow

MarStar 240SC

Length	24' 10"	24' 10"
Width (amidship)	96"	96"
Height (low bar to water line)	34"	34"
Weight (without fuel)	3500 lbs	3950 lbs
Draft at Stop	24"	22"
Depth at Transom	28"	28"
Depth (amidship)	48"	38"
Fuel Capacity (Approximate)	53 gallons	44 gallons
Fuel Filter Type	Racor R11S	Racor R11S
Fuel Requirement (Octane)	93 RON/89 AKI	93 RON/89 AKI
Top Speed (Approximate)	47 mph	47 mph
Battery		
Capacity (Cold Cranking Amps)	525	525
Group Type	C-24	C-24

Engine

351 Ford

351 Ford

Horsepower	250	250
RPM		
Idle (In Gear)	600	600
Maximum (In Gear)	4600	4600
Bore	4.00"	4.00"
Stroke	3.50"	3.50"
Cubic Inches	351	351
Point Dwell	30°	30°
Timing		
Black Distributor Cap	10° @ 600 rpm	10° @ 600 rpm
Tan Distributor Cap	6° @ 600 rpm	6° @ 600 rpm
Spark Plug Type and Gap	BTFSM/.035"	BTFSM/.035"
Firing Order	1-3-7-2-6-5-4-8	1-3-7-2-6-5-4-8
Oil Filter Type	FL1A	FL1A
Oil Type	SAE 30/API SF	SAE 30/API SF
Alternator Output	51 amp	51 amp

Transmission

1.5:1 Ratio

1.5:1 Ratio

Oil Type	Dexron II	Dexron II
Oil Capacity	3 qts	3 qts
Propeller (L.H. Rotation)	14" x 18" cupped	14" x 18" cupped

GRAPNEL

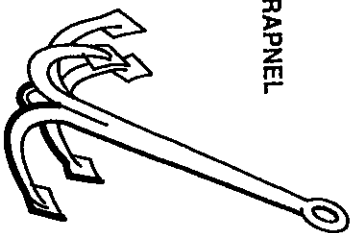

NORTHILL

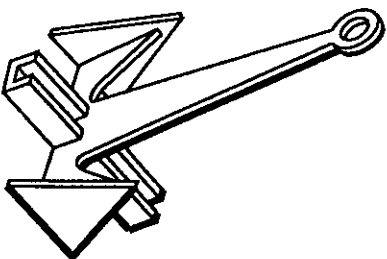

STOCKLESS

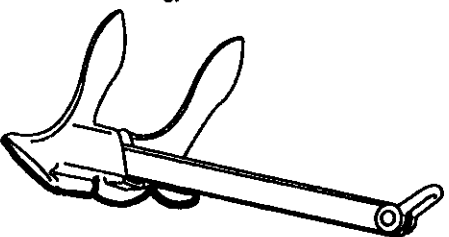

OPTIONAL EQUIPMENT

Power Slot Package

The power slot package consists of a 1.5:1 transmission ratio for greater pulling power.

Fresh Water Cooling System

The fresh water cooling system is self-contained and consists of a water to coolant heat exchanger, reservoir and interconnecting hoses. Water supplied by the raw water system removes heat from engine coolant in the heat exchanger. The engine water pump circulates coolant throughout the system.

Although clean water alone could be used in this system, we recommend that a 50/50 solution of soft, clean water and automotive antifreeze be used to prevent corrosion. The only additional maintenance considerations are an annual check of antifreeze protection and the addition of water pump lubricant according to manufacturer's instructions.

Boat Cover and Mooring Cover

A boat cover is a must for all boats. Protection from rain, birds and the damaging effects of ultraviolet light will help keep the boat looking new for years. Keep the cover on during all periods of non-use except when trailering.

Trick Release

A trick release is mandatory equipment for all skiing involving the use of toe or leg holds. The release, permanently attached to the tournament tow bar allows the ski observer to quickly release the rope in the event of a fall.

Heater

The self-contained automotive type heater has two adjustable vents, for operator and observer. To use the heater, before starting the engine open the engine box and locate the heater valve on the engine intake manifold. Open valve fully. After engine has

started, turn accessory switch ON for heat. Close heater valve fully when not using heater.

The heater is maintenance free except for the removal of any water from the core and hoses during winter storage.

NOTE

If the boat is equipped with both a heater and fresh water cooling; and if adequate antifreeze protection is used, the heater does not need to be emptied of coolant during winter storage.

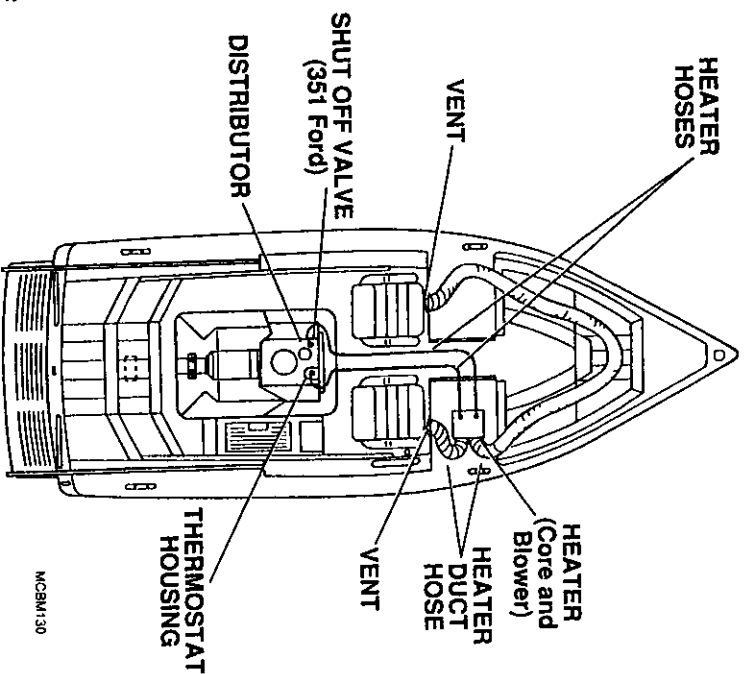

Open Bow Routing Shown

MCBM130

Airguide Speedometer

The adjustment knob is used for precise calibration. The reference guide knob is set to the desired speed to be used as a quick reference guide in maintaining that speed.

For tournament practice, accurate speedometer readings are a must. To calibrate the speedometer you need an accurately measured course of 850 feet and a certified stopwatch accurate to a thousandth of a second. To calibrate to AWSA official tournament rules:

1. Approach the course at an indicated 36 mph. Hold the speed steady and have an observer check course time with a stopwatch.
2. If course time is between 15.88 and 16.28 seconds, no adjustment is necessary.
3. If course time is not within tolerance, turn adjustment knob as needed until correct time is obtained.

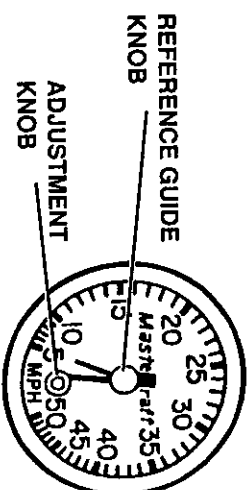

MCBM131

Tonneau Cover

A tonneau cover offers protection from the elements when docked or under use. The cover snaps tightly in place and should be used whenever possible.

Sun Top

The sun top provides relief from both sun and rain. In the stored position, the top lays on the deck behind the rear seat. To raise the top, remove the zippered boot, slide it forward to the end of the rails, fasten the snaps to the top of the windshield frame, and hook the straps to the eyelets on the gunwale.

DEALER SERVICE AND WARRANTY

Dealer Service

Your MasterCraft Dealer has been carefully chosen to provide you with expert service when needed. He is equipped with the latest service information and techniques for competent and courteous routine maintenance and service. He will also be glad to assist you with "do-it-yourself" replacement parts and advice.

For your safety, when replacing any parts on your MasterCraft, be sure to use genuine MasterCraft replacement parts or parts approved by USCG and ABYC. Never use automotive replacement parts for marine applications. In many cases, automotive parts are not designed to offer you the safety and durability needed for marine use.

Warranty Service

Although MasterCraft boats are highly reliable, a problem may develop on occasion. If the boat is still under warranty, you may bring it to any one of the over 120 dealers in our network. If you have questions regarding warranty coverage, ask your dealer or contact the factory directly by writing to: Warranty Department, MasterCraft Boat Co. (MCB), Rt. 9 Box 152, Maryville, TN 37801.

Warranty Registration

At the time of purchase of your MasterCraft, you and your dealer **must** fill out all portions of the warranty registration card. It is extremely important that the registration information card be filled-in at the time of sale and be mailed to the address shown on the card within 14 days of purchase. The information on this card is not only used to validate the warranty, enabling you to receive service, but also allows MCB to comply with the Federal Boating Safety Act, which will ensure your notification should a recall campaign be started. We will also be able to keep you informed of new accessories and service items that may become available to you; and this information will aid law enforcement officials and insurance companies in recovery of stolen boats. Original

purchasers should inform MCB of any change of address for the same reasons.

Warranty Claims

To make a claim under warranty, contact the MasterCraft dealer from whom your boat was originally purchased, or the nearest dealer. It is recommended that warranty service on your MasterCraft be performed by the original dealer because of his personal interest in you. Remember, your MasterCraft must be delivered to a dealer within 10 days of discovery of the defect for it to be covered. Proof of purchase may be required by the dealer to substantiate any warranty claim.

During the period of warranty, any authorized MasterCraft dealer will (free of charge), repair or replace, at MCB's option, any item manufactured by MCB, that proves to be defective, upon examination by MCB, due to faulty workmanship or material from the factory. All replaced parts will become the property of MasterCraft Boat Co.

Owner's Warranty

Responsibilities

Under the terms of this warranty, the owner is responsible for ensuring that the boat is registered for warranty; properly operated, maintained, and stored in accordance with the owner's manual.

The owner of the boat shall give notice of any and all apparent defects within ten (10) days of discovery and deliver the boat for inspection and repairs at the MasterCraft dealer. The owner is also responsible for returning the boat from the MasterCraft dealer.

Owner's Boating

Responsibilities

As the owner of a boat, you have certain responsibilities that must be acknowledged before taking to the water for the first time. In many cases your MasterCraft dealer will be able to help you meet these responsibilities.

Registration - All power boats operated on (federally controlled) navigable waters of the United States must be numbered (registered) in the state of principal use. Contact your state boating authorities for an application for a Certificate of Number.

Insurance - Insurance for your MasterCraft should be obtained as soon as practical for protection against loss by fire, theft, etc. In addition, additional liability protection is recommended. Consult your insurance agent.

Periodic Maintenance - Maintaining your boat in good working condition is a condition of warranty as well as an important safety habit and will add to the resale value. Implement a routine for periodic maintenance, including daily checks. Consult your MasterCraft dealer.

Briefing Passengers - Whenever you are going for an outing, make sure that at least one passenger is familiar with the operation and safety aspects of the boat in case of emergency. Show all passengers the location of emergency equipment and how to use it.

Courtesy - By and large, boaters are a friendly group. Know the rules of the road and learn the peculiar patterns of any body of water. Give fishermen and sailors plenty of room and look for personal water vehicles. Keep speeds down in congested and restricted areas. You are responsible for spotting and avoiding swimmers and slow moving vessels. You are also responsible for any damage caused by your wake. Don't throw refuse overboard or discharge liquids such as oil. Help to keep boating fun for everyone! Ask your local Coast Guard Auxiliary or state boating authorities for more information on boating courses and the like.

Storage - Proper storage of your boat and trailer during the "off season" will make reactivating a lot easier. A few hours of preparation can save both time and money come spring. Consult your MasterCraft dealer for storage supplies or services.

THE MASTERCRAFT LIMITED WARRANTY

- MasterCraft warrants to the **original** retail purchaser that each new boat is free from structural defects in material and workmanship under normal use and when operated and maintained according to the operator's instructions, for a period from date of purchase of:
- I. Ten (10) years on the deck, hull, liner, and stringers.
 - II. One (1) year on component parts manufactured by MasterCraft.
- Subject to the terms of the Limited Warranty, any covered boat or part with structural defects in material or workmanship that is returned to MasterCraft's factory or authorized repair facility during the above stated warranty periods will, at MasterCraft's option, be repaired or replaced without charge to the owner. The terms of this Limited Warranty are as follows:
- I. MasterCraft shall repair or replace at its option, any item that proves defective upon examination by MasterCraft's authorized personnel.
 - II. MasterCraft warrants said repairs or replacements for the remainder of the warranty period.
 - III. MasterCraft shall fulfill its obligation to repair or replace the defective item within 90 days of receipt of the defective item at its factory or authorized repair facility.
 - IV. MasterCraft's obligation under this warranty shall be limited to the repair or replacement of any item judged defective by MasterCraft.
- V. The owner shall be responsible for transportation of the boat or part(s) to the authorized MasterCraft facility and for any return transportation cost of said item.
- MasterCraft boats are manufactured by trained craftsmen from high quality materials and components, however conditions outside MasterCraft's control require specific exclusions from coverage under this warranty. The MasterCraft Warranty Does Not Include the following:
- I. Any damage or repair required because of misuse, negligence, accident, collision, or impact, with any object, or any improper alteration or repair.
 - II. Any boat used for speed, commercial competition or performance demonstration.
 - III. Any boat which is: (a) used for rental or other commercial or industrial purposes; (b) used in boat racing, demonstrations, or similar events; (c) altered, modified, repaired, or replaced so as to increase the cubic inch capacity or horsepower output of the engine and boat as originally manufactured.
 - IV. All component parts and accessories not manufactured by MasterCraft, including but not limited to, engines, drive trains, transmissions, propellers, shift and throttle control levers and cables, pumps, blowers, windshields, canvas, upholstery, instrumentation and steering systems. However, where any such items are warranted by a component or accessory manufacturer, MasterCraft will, if possible, furnish the manufacturer's warranty document to the owner.
 - V. The ten (10) year Warranty on the deck, hull, and liner covers only the named items and does not include hardware and other components fastened or adhered to the hull, deck, or liner.
- VI. Paints, varnishes, gelcoat surfaces and colors, finish distortions, chrome plated or anodized finishes, floor and floor covers and any other surface coatings. **IMPORTANT.** MasterCraft has been made aware that an increasing number of owners are leaving their boats in the water for long periods of time. Although MasterCraft uses the high grade NPG gelcoat materials, a condition may develop where the bottom may show signs of discoloration and/or blisters. Should this condition occur, it will not be covered by warranty from MasterCraft or its suppliers. It is suggested that for boats required to stay in the water for long periods, that a good bottom paint be applied for additional protection.
- VII. Liability for special or consequential damages, such as, but not limited to consequential relating to, for third party claims against the purchaser, or damages for loss of profit. Any implied warranty of merchantability, fitness for a particular purpose, or otherwise, are limited to the duration of the applicable express warranty.
- VIII. Note: Some states do not allow limitation on how long an implied warranty lasts or a limitation of accidental or consequential damages; therefore, these limitations may not apply.

MASTERCRAFT BOAT COMPANY, INC.

Route 9, Box 152

Maryville, Tennessee 37801

NOTES